



ITT

Goulds Pumps

# Goulds 3180

Heavy Duty Process Pump with  
Patented *i-ALERT™* Intelligent Monitoring

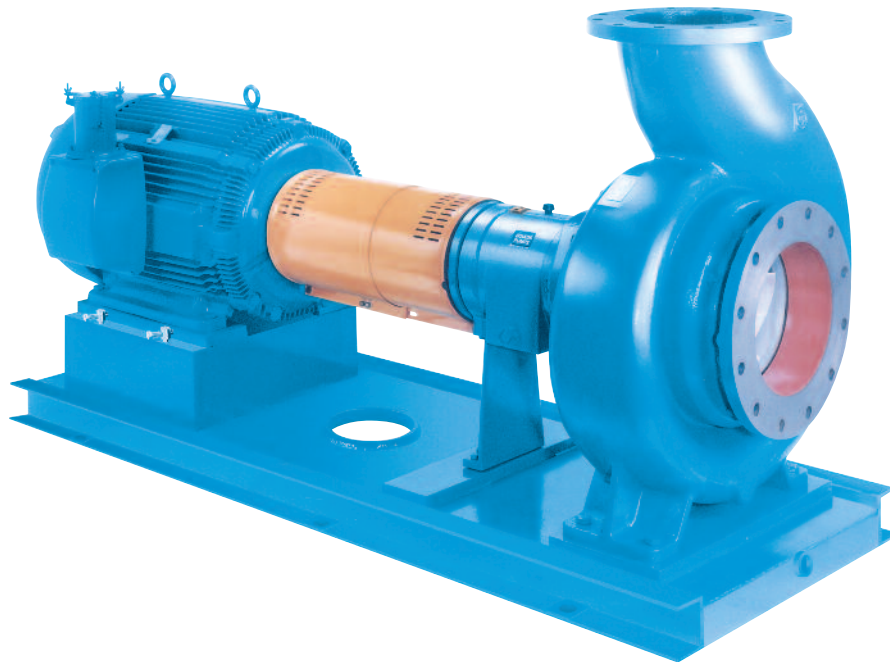

*Engineered for life*

**motralec**

4 rue Lavoisier . ZA Lavoisier . 95223 HERBLAY CEDEX  
Tel. : 01.39.97.65.10 / Fax. : 01.39.97.68.48  
Demande de prix / e-mail : [service-commercial@motralec.com](mailto:service-commercial@motralec.com)  
[www.motralec.com](http://www.motralec.com)



Top: A Model 3180 installed in a North American recycle mill.



Above: Model 3180XL on difficult high temperature service. Spring-mounted baseplate provided to compensate for thermal expansion.

Below: Cooling water pump for primary turbine at a power plant in the Middle East.



- ◆ Capacities to 40,000 GPM (9000 m<sup>3</sup>/h)
- ◆ Heads to 410 feet (125m)
- ◆ Temperatures to 446°F (230°C)
- ◆ Pressures to 232 PSIG (16 bar)

## Goulds 3180

---

### Worldwide Experience on Process Pumping Services

When Goulds developed the 3180, we utilized 140 years of pump design experience to ensure it would have unmatched mechanical reliability.

Today, installations around the world attest to its remarkable performance.

The 3180 is the heavy duty process pump designed to handle all of your tough process pumping applications.

### World-class Pump Line

---

Model 3180 is built to ANSI standards.

- ◆ ANSI class 125/150 lb. flange drilling
- ◆ Inch-dimensioned O.D. of mechanical seal sleeve
- ◆ Inch-dimensioned bearing locknut
- ◆ Inch-dimensioned shaft and keyway at coupling

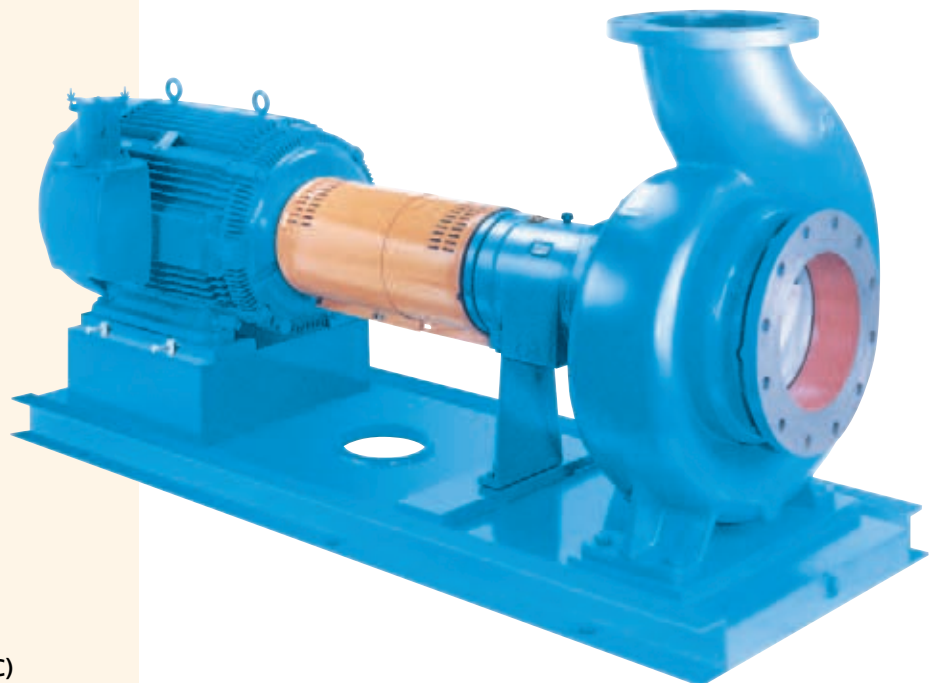



# Gooulds 3180

## Featuring *i-ALERT*<sup>™</sup> Patented Intelligent Monitoring

### PATENTED *i-ALERT* CONDITION MONITOR

Constantly measures vibration and temperature at the thrust bearing. Colored LED's indicate general pump health. Provides early warning of improper operation before catastrophic failure occurs.

### STANDARD LABYRINTH OIL SEALS

Prevent premature bearing failure caused by lubricant contamination and loss of lubricant.

### CONTINUOUS HIGH-PERFORMANCE

Original high efficiency maintained by simple external impeller adjustment resulting in long term energy savings.

### HEAVY-DUTY SHAFT

Designed for minimum deflection at maximum load. Dry shaft achieved by sealing from pumpage by O-rings at sleeve and impeller nut.

### RIGID FEET

Large casing and bearing frame feet maintain driver alignment with high pipe loads; absorb system vibration.

### SEALING FLEXIBILITY

Choice of mechanical seal (illustrated), packed box or dynamic seal.

### PATENTED TAPERBORE<sup>™</sup> PLUS SEAL CHAMBER

Wide range of sealing arrangements available to meet service conditions. Patented seal chambers improve lubrication and heat removal (cooling) of seal faces for extended seal life and pump uptime.

### CASING

Top centerline discharge for air handling and self-venting. Special volute design reduces radial loads. Back pull-out design. Foot-mounted.

### RENEWABLE SUCTION SIDEPLATE

With open impeller design minimizes maintenance costs. Positively sealed with O-ring and gasket.

### OPEN IMPELLER

Full back shroud and thick impeller vanes for handling slurries and stringy fibers. Large balance holes and back pump-out vanes minimize stuffing box pressure and axial thrust. Optional enclosed impeller available. Shearpeller<sup>™</sup> design available for difficult recycle services.

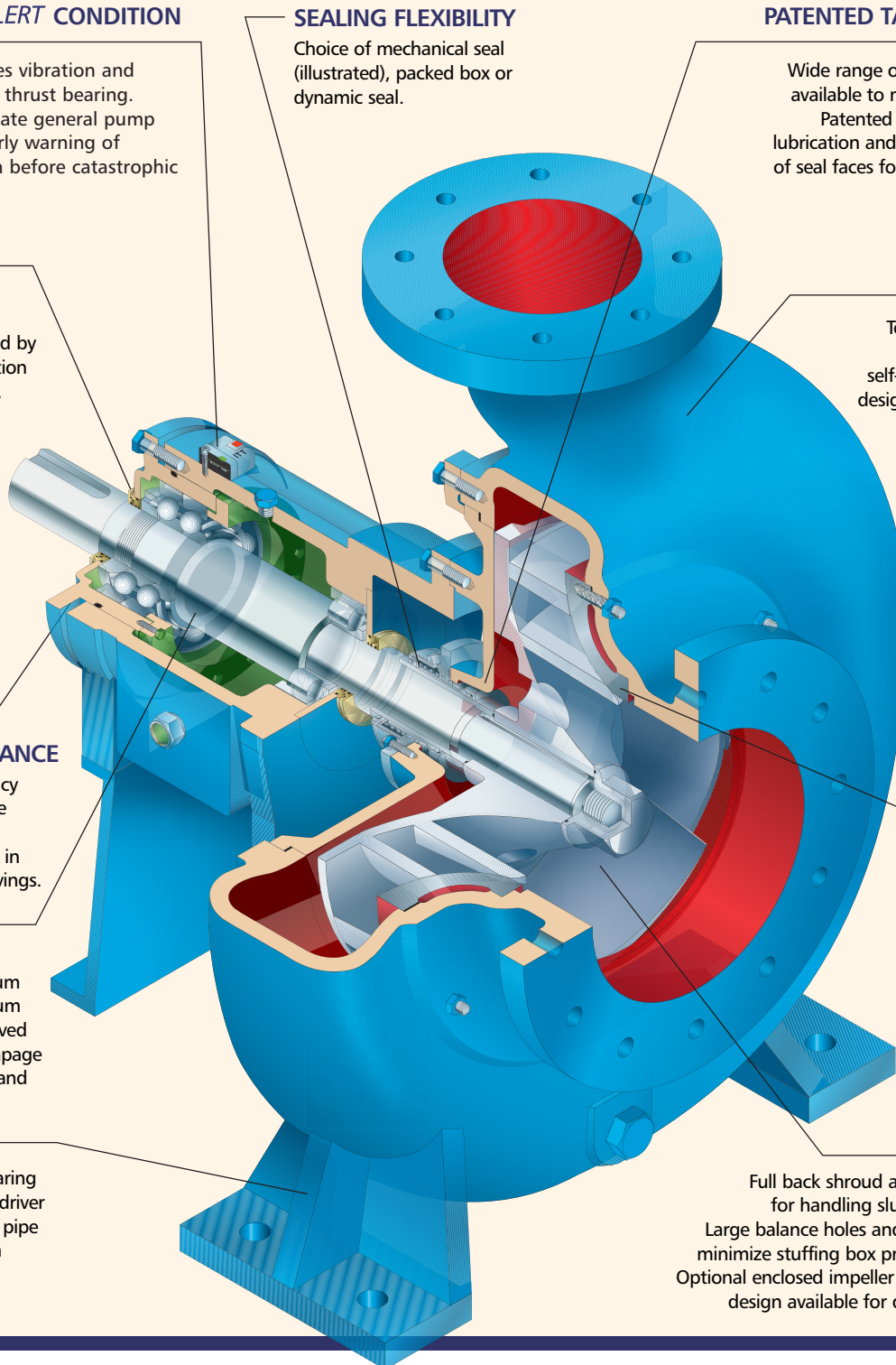



## Engineered Impeller and Sideplate

Acknowledged best design for industrial process services

### It offers:

- 1 Ease of adjustment to maintain optimum performance
- 2 Clamped sideplate for maximum reliability and zero leakage
- 3 Minimum hydraulic loads for maximum mechanical reliability

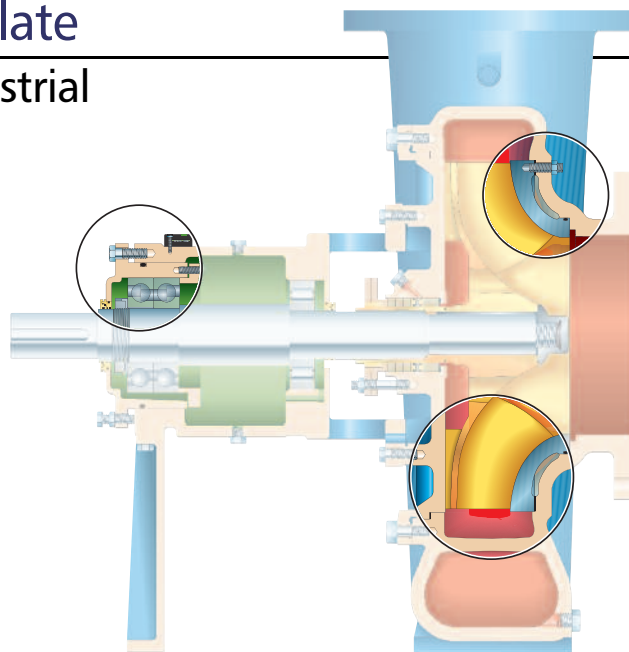

## Renewable High-performance Easy and reliable

1

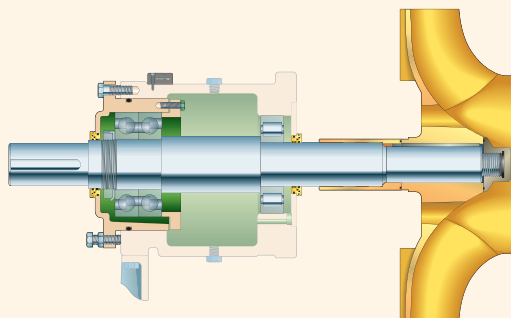

VS.

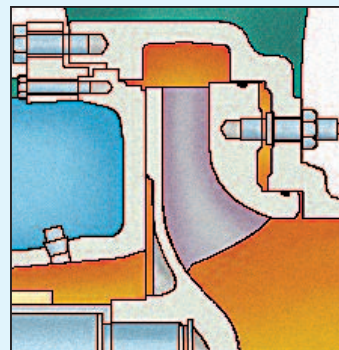

With any impeller adjustment there will be two metal components that will have to move relative to each other. Goulds puts this precision fit in the sealed and lubricated environment of the power end.

Less reliable pumps utilizing adjustable sideplates are difficult to adjust, are not precise in clearances and the adjustment must take place in the corroded casing interior leading to leakage. Improper adjustments lead to broken studs and catastrophic failure.

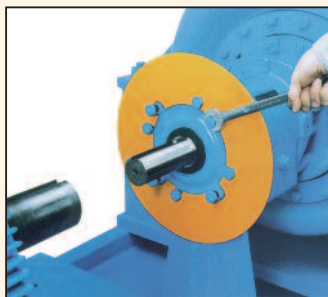

VS.



Easy and accessible adjustments. The Goulds adjustment bolts are very accessible and can be adjusted with one tool.

The adjustable sideplate method requires two tools. Additionally, the pump suction flange limits the accessibility to the adjusting screws.

## Clamped Sideplate

For maximum reliability and zero leakage

# 2

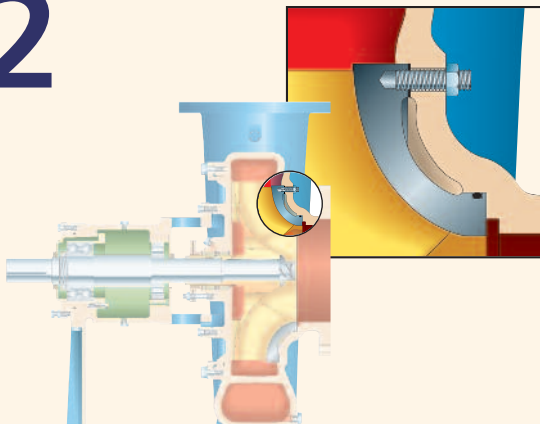

**CLAMPED**

Our sideplate is clamped securely and sealed positively to ensure that it does not lead to breakage or leakage.

VS.

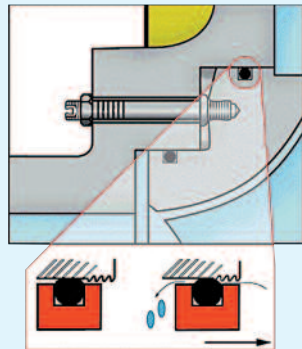

**FLOATING**

The "floating" sideplate design must scrape over a casing surface that will be corroded and fouled. This commonly leads to a leakage path through the sideplate studs.

## Minimum Hydraulic Loads

Maximum mechanical reliability

**3** Goulds open impeller design was engineered to assure minimum radial and axial thrust loads to maximize seal and bearing life.



- 1** Full back shroud — maximizes mechanical integrity
- 2** Balance holes — Low axial thrust
- 3** Engineered back vanes — Extended seal and bearing life.

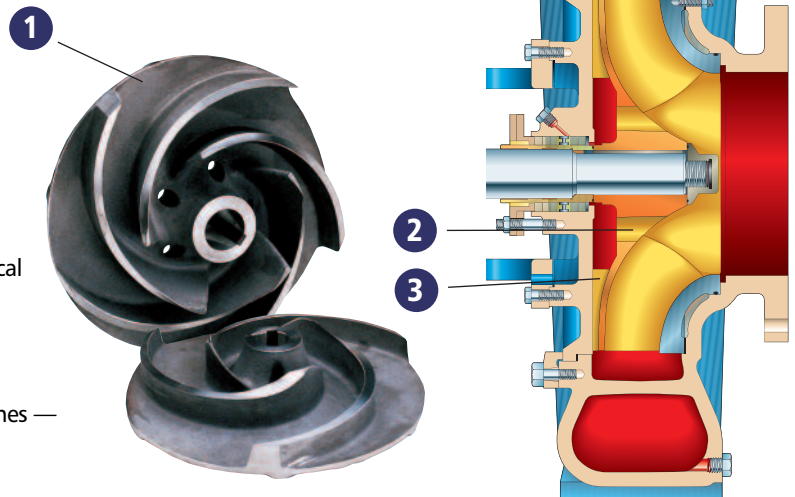

### ENGINEERED FOR LONG LIFE

Back vane height/angle and shroud design are engineered to minimize hydraulic loads throughout the life of the pump. Bearing life is guaranteed.

As the open impeller is adjusted and performance renewed, back pump-out vanes control axial thrust.

Bearing and seal life are maintained — unaffected by adjustment.

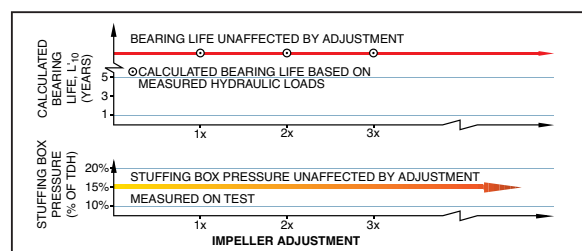

# Power Ends Designed for Maximum Reliability

Power End Reliability is vital when thinking about pump *mean time between failure* (MTBF). To ensure maximum bearing life, the 3180 follows four key factors:

- 1 Bearing Design Life
- 2 Bearing Temperature
- 3 Bearing Environment
- 4 Continuous Condition Monitoring

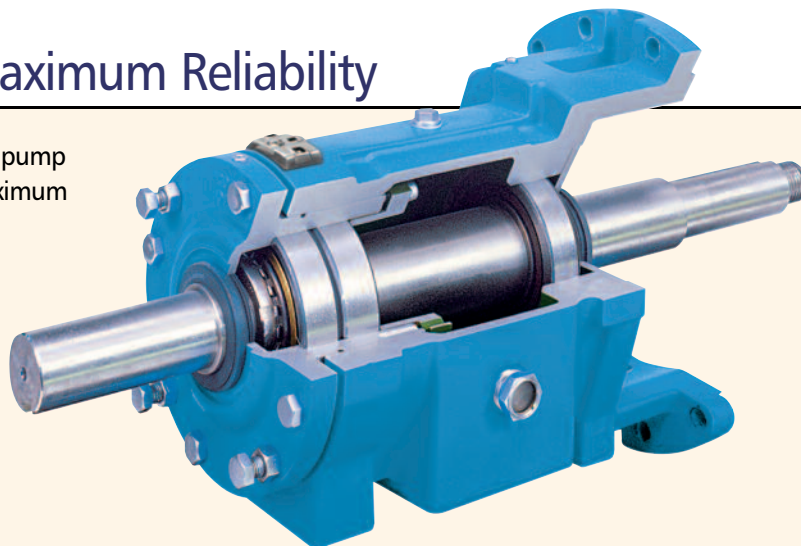

## 1 Bearing Design Life

Bearing manufacturers state that skidding, cage stresses and oil temperatures can greatly reduce the bearing life of oversized bearings. The "right" size bearing is vital to overall bearing life.

*Bearing Load Measured on Test*

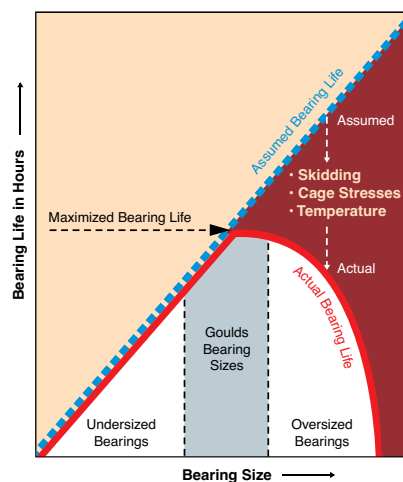

**Bigger is NOT always better!**

Bearings are often oversized because pump designers often estimate bearing loads. Goulds measured their loads on test and chose bearing designs that would enable bearing life of 100,000 hours.

## 2 Bearing Temperature

Keeping the pump loads minimized and selecting the "right" bearing will keep bearing temperature under control.

*Bearing Temperature vs. Size*

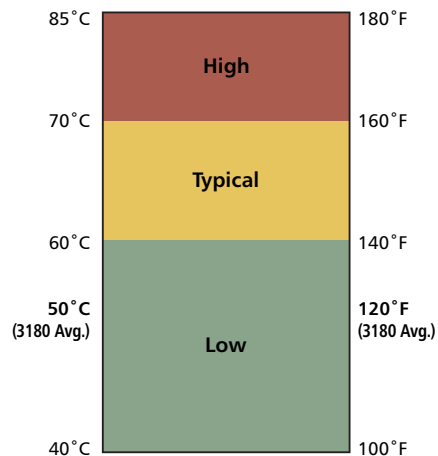
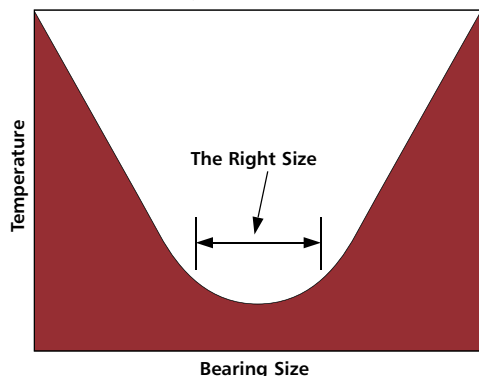

Typical bearing operating temperatures of competitor's process pumps are between 140-160°F. Goulds Model 3180 bearing temperatures average only 120°F/ 50°C!



# 3 Bearing Environment Labyrinth Oil Seals are Standard

Contamination being the second leading cause of bearing failure requires special attention. Common lip seals were not considered due to their 2,000 hour design life. After wearing out, there will be an open passage way for contamination. For this reason, our 3180 is supplied with Inpro VBXXD labyrinth oil seals as standard. The Inpro VBXXD is the industry's leading bearing isolator and provides the best operating environment for the bearing.

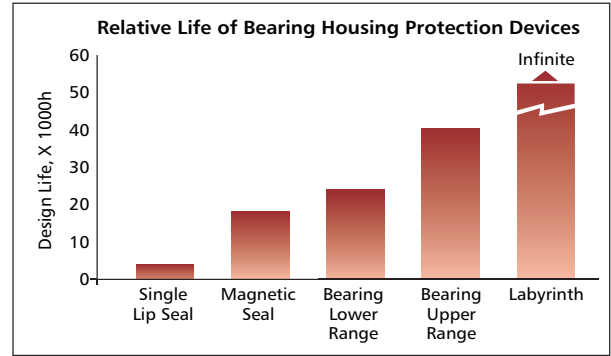

### RIGID FRAME FOOT

Heavy duty foot reduces effects of pipeloads/ thermal expansion on bearing life. Bearings continue to run cool.



### LARGE OIL SIGHT GLASS

The standard oil sight glass assures oil level is properly set and maintained. Condition of oil is also easily monitored.

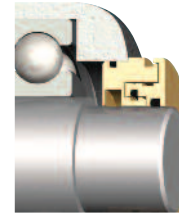

### STANDARD LABYRINTH OIL SEALS

Prevent contamination of lubricant for extended bearing life.

# 4 Patented *i-ALERT*™ Condition Monitor

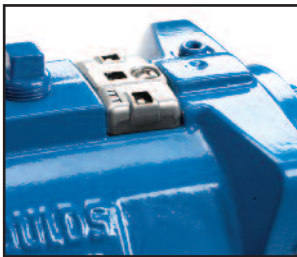

The *i-ALERT* Condition monitor unit continuously measures vibration and temperature at the thrust bearing and automatically indicates when pre-set levels of vibration and temperature have been exceeded, so that changes to the process or machine can be made before failure occurs.

A visual indication of pump health makes walk-around inspections more efficient and accurate. The result is a more robust process to monitor and maintain all your pumps so that your plant profitability is maximized.

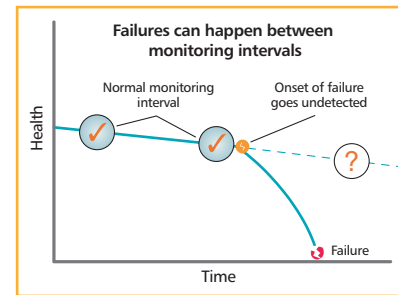

A reliability program centered around walk-arounds captures equipment condition on average once a month; the failure process, however, can begin and end quite frequently within this time period.

## Power end reliability is both designed-in and guaranteed

- Bearing Design Life..... ✓ (>100,000 hours)
- Bearing Temperature..... ✓ (120°F/50°C) average)
- Bearing Environment..... ✓ (Superior Oil Seal design)
- i-ALERT*™..... ✓ (Condition Monitoring)
- Guarantee..... ✓ (Reliability Guarantee)

### Our guarantee

*Goulds Pumps backs the 3180 power ends with an unconditional guarantee against defects in workmanship and material for 3 years from date of manufacture.*



## Impeller Designs to Optimize Performance

The right design for the service results in optimum efficiency and up-time, especially when handling difficult media such as recycle fibers with contaminants.

**1**

### Open Impeller

Design suitable for most services. Allows for resistance to wear and corrosion. Provides for easily renewable clearances. Designed for optimum efficiency.



**2**

### Enclosed Impeller

Available for services where efficiency is a consideration and enclosed design is suitable for service conditions. Efficiency can be renewed with axial adjustment and/or wear ring replacement. Also beneficial for high temperature services as it allows the suction sideplate to be eliminated.



## Goulds clog-free pumping solution patented design (# 6,609,890)

Pumping applications in recycle mills present unique challenges with the presence of plastic and tape along with other contaminants that can readily clog the pump impeller.



**3**

### The Goulds Shearpeller™ solves this problem:

- ◆ Generous front clearance with vortex-type design to prevent binding and plugging.
- ◆ Patented tapered inlet sleeve prevents contaminants from plugging inlet area. The sleeve is loose to rotate independently from impeller. The slower rotation prevents contaminants from collecting at the impeller eye and prevents erosion of hub.
- ◆ Proven in tough services such as repulper dump service in OCC recycle mill. In one service, pump went from a daily outage to clear impeller to uninterrupted, continuous service.
- ◆ Component changes only involve the impeller and sleeve. Uses same casing, sideplate, shaft and impeller nut as 3180.

## Optimize Seal Configuration for Service and Environment

**1**

### For services with solids and vapor Goulds patented\* TaperBore™ PLUS

The unique flow path created by the patented Vane Particle Ejector directs solids away from the mechanical seal, not towards the seal as with other tapered bore designs. And, the amount of solids entering the bore is minimized. Air and vapors are also efficiently removed.

On services with or without solids, air or vapors, Goulds patented TaperBore™ PLUS is the effective solution for extended seal and pump life and lower maintenance costs.

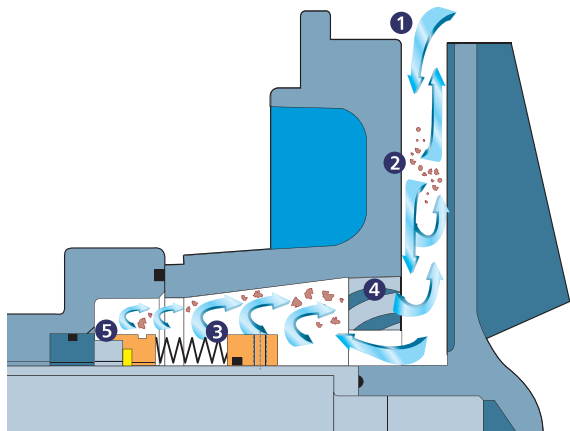

\*U.S. Patent No. 5,336,048

- 1** Solids/liquid mixture flows toward mechanical seal/seal chamber. Turbulent zone. Some solids continue to flow toward shaft.
- 2** Other solids are forced back out by centrifugal force (generated by back pump-out vanes).
- 3** Clear liquid continues to move toward mechanical seal faces. Solids, air, vapors flow away from seal.
- 4** Low pressure zone created by Vane Particle Ejector. Solids, air, vapor liquid mixture exit seal chamber bore.
- 5** Flow in patented TaperBore™ PLUS seal chamber assures efficient heat removal (cooling) and lubrication. Seal face heat is dissipated. Seal faces are continuously flushed with clean liquid.



## 2 Zero flush water (Mechanical seals)

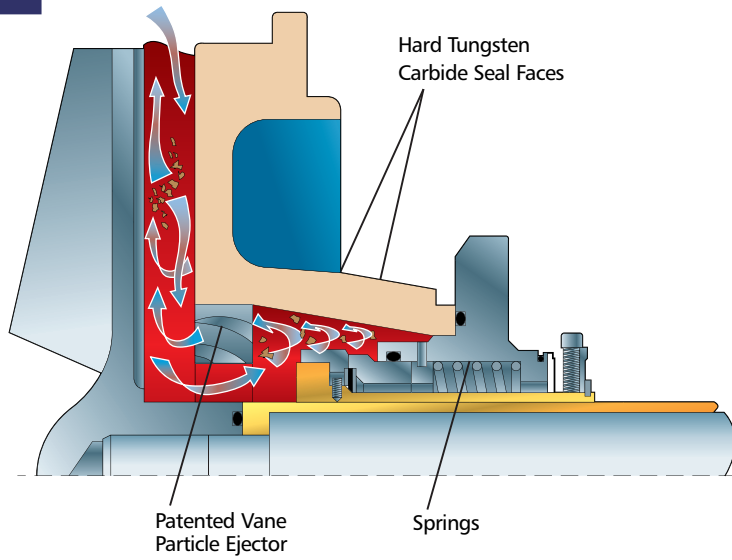

*The 3180 has a revolutionary seal chamber design guaranteed to operate on 6% paper stock without flush water!*

PATENTED! No. 5,336,048

Aside from the high cost of flushing mechanical seals and the possible dilution of the product, contaminants in the flush water can also cause seal failures. Disruption of flush water caused by plugging, freezing or inadvertently closing a valve can also cause failures.

The answer to those problems is solved with the Goulds patented TaperBore™ PLUS.

## 3 Dynamic seal For elimination of mechanical seal problems; reduced maintenance

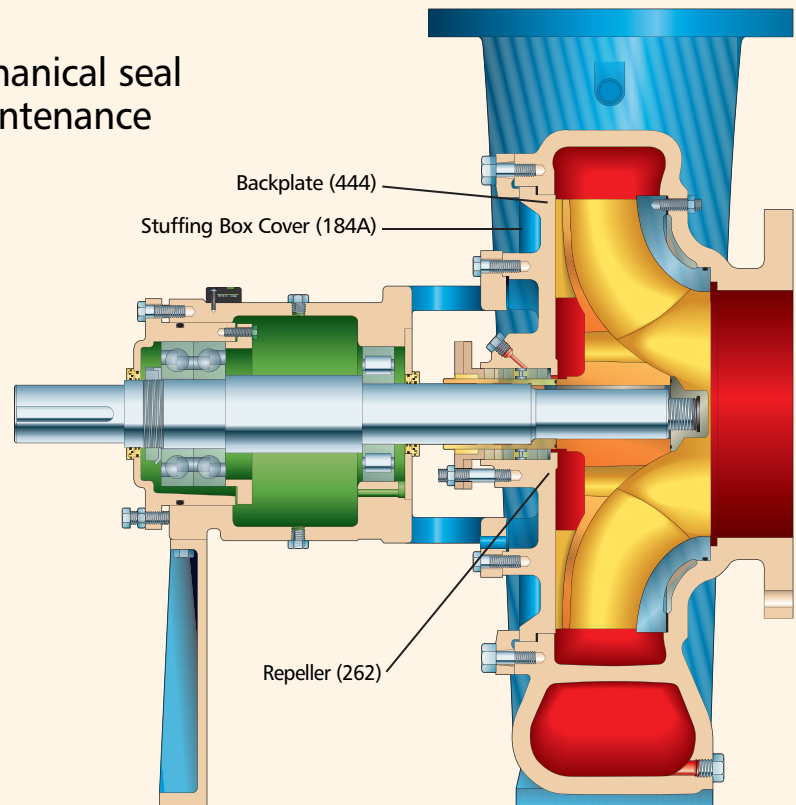
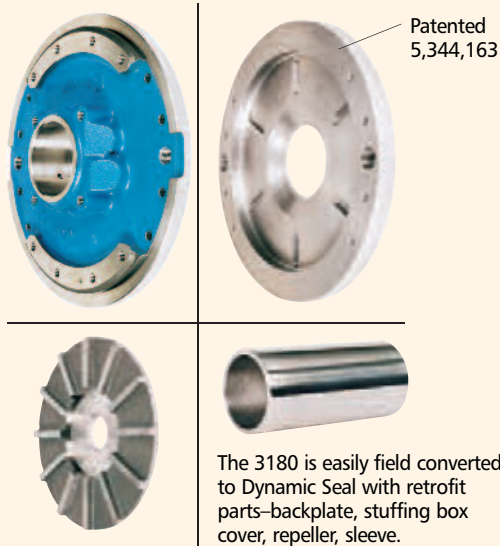

Goulds *Dynamic Seal* option is ideally suited to handle the tough applications where conventional mechanical seals or packing require outside flush and/or constant, costly attention. This option allows pumping slurries without an external flush. A repeller between the stuffing box cover and impeller pumps liquid from the stuffing box while the pump is running. A diaphragm seal prevents leakage when the pump is not operating.

### Benefits of Goulds Dynamic Seal:

- ◆ External seal water not required.
- ◆ Elimination of pumpage contamination or product dilution.
- ◆ Eliminates problems and costs associated with piping from a remote source.

# Hydraulic Coverage 50 Hz

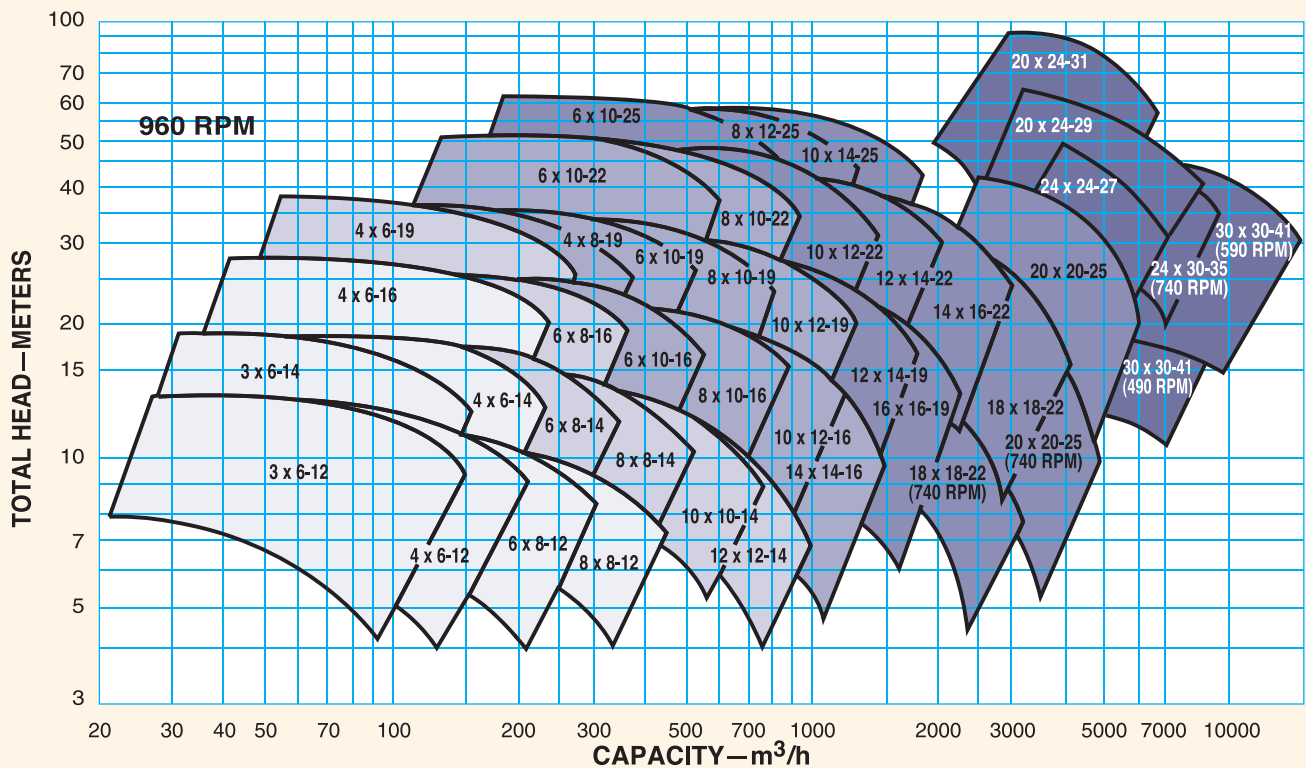
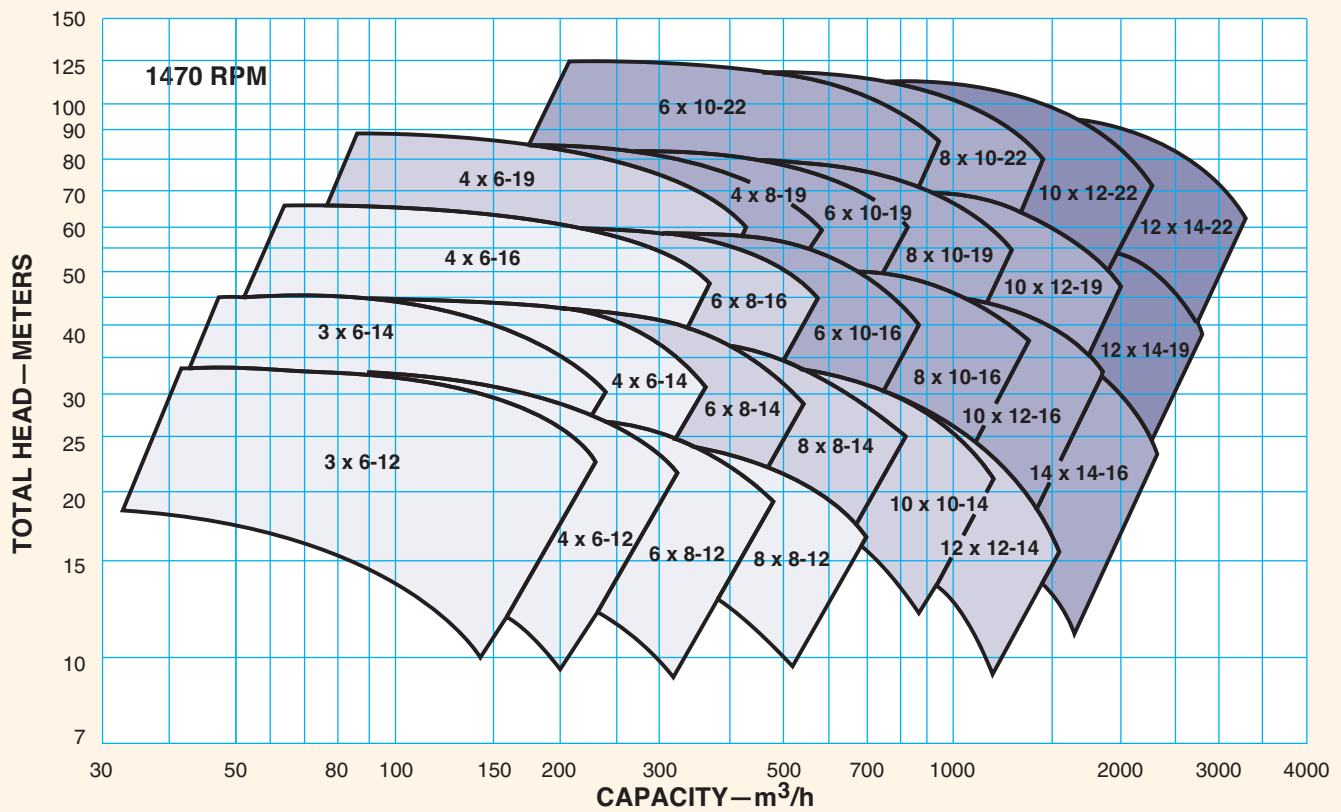

\*Available with Shearpeller™

# Hydraulic Coverage 60 Hz

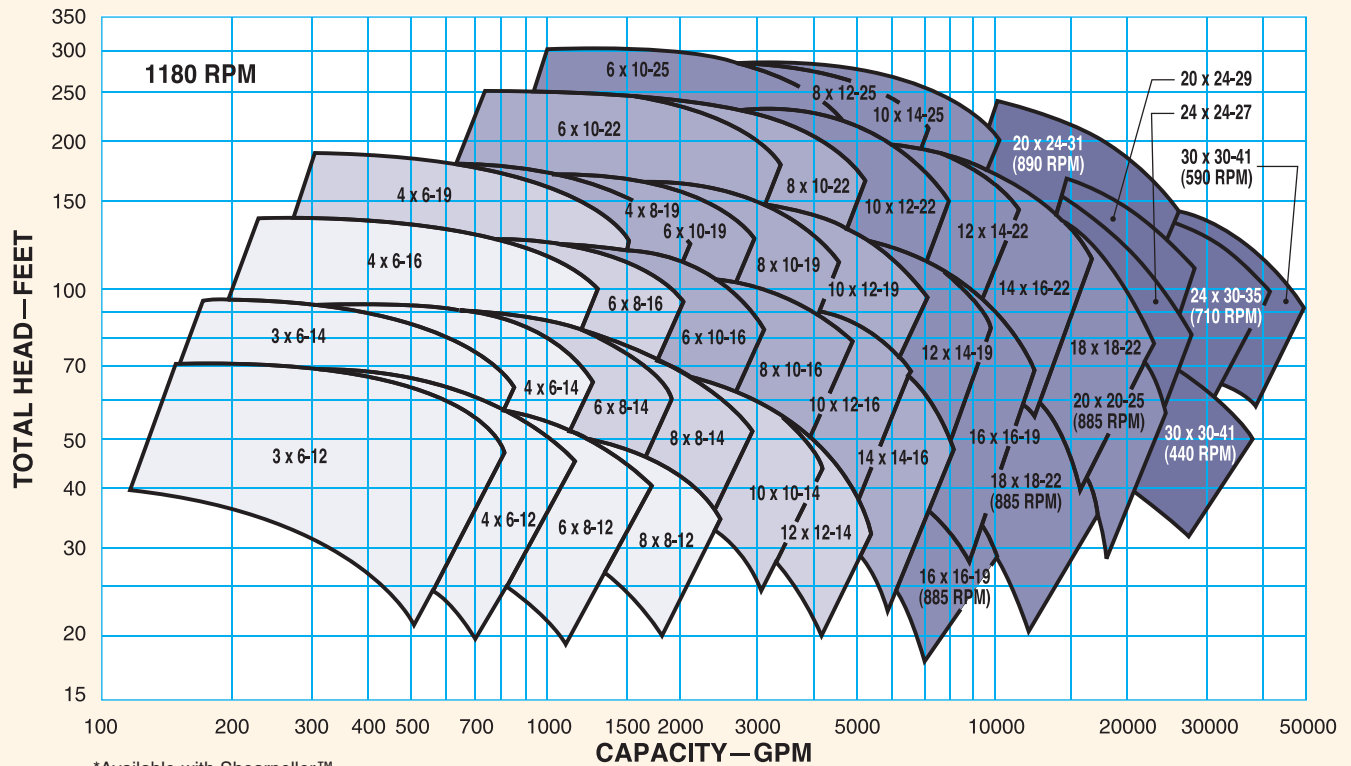
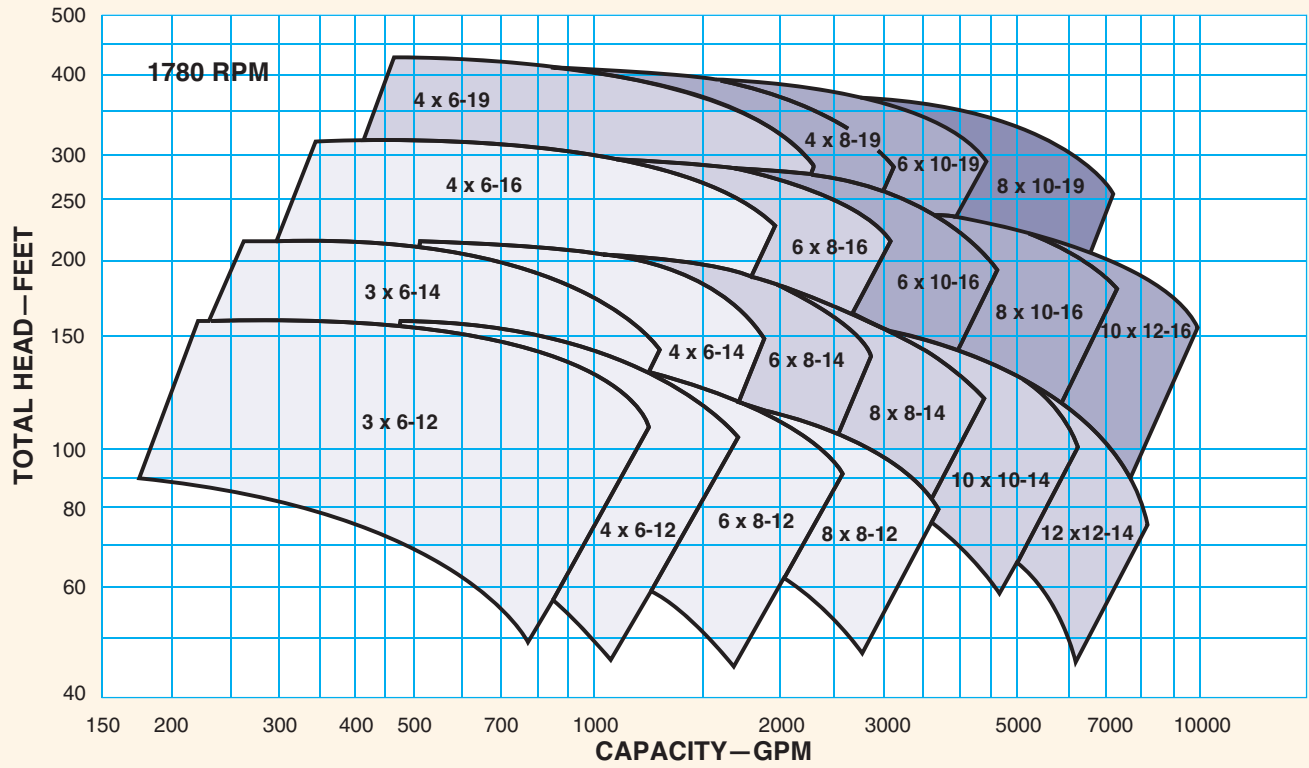

\*Available with Shearpeller™



# Parts List and Materials of Construction

Item Number	Part Name	Material				
		All Iron/SS Impeller	All Iron/SS Impeller, SS Sideplate	All 316SS	All CD4MCuN	All 317SS
100	Casing	Cast Iron	Cast Iron	316SS	CD4MCuN	317SS
101	Impeller <sup>1</sup>	316SS	316SS	316SS	CD4MCuN	317SS
105	Lantern Ring	Teflon <sup>®</sup>				
106	Packing	Teflon <sup>®</sup> Impregnated Fibers				
107	Gland	316SS				
108	Frame Adapter <sup>3</sup>	Ductile Iron				
112	Thrust Bearing	Duplex Angular Contact				
122	Shaft	Carbon Steel (4340)				
126	Shaft Sleeve	316SS	316SS	316SS	316SS	317SS
126A	Shearpeller™ Sleeve	N/A	Carbon-filled Teflon			N/A
134A	Bearing Housing	Cast Iron				
136	Bearing Locknut and Lockwasher	Steel				
159	Seal Chamber (Mechanical Seal)	Cast Iron	Cast Iron	316SS	CD4MCuN	317SS
164	Case Wear Ring (Enclosed Impeller)	316SS	316SS	316SS	CD4MCuN	317SS
176	Suction Sideplate (Open Impeller)	Cast Iron	316SS	316SS	CD4MCuN	317SS
178	Impeller Key	AISI 303				
184	Stuffing Box Cover (Packed Box)	Cast Iron	Cast Iron	316SS	CD4MCuN	317SS
184A	Stuffing Box Cover (Dynamic Seal Option)	316SS	316SS	316SS	CD4MCuN	317SS
202	Impeller Wear Ring (Enclosed Impeller) <sup>2</sup>	316SS	316SS	316SS	CD4MCuN	317SS
228	Bearing Frame	Cast Iron				
262	Repeller (Dynamic Seal Option)	316SS	316SS	316SS	CD4MCuN	317SS
304	Impeller Nut	316SS	316SS	316SS	CD4MCuN	317SS
332A	Labyrinth Seal, Outboard	Bronze				
333A	Labyrinth Seal, Inboard	Bronze				
351	Casing Gasket	Aramid Fiber with EPDM Rubber				
353	Mechanical Seal	As Required				
356E	Stud, Casing Wear Ring	304SS				
357A	Nut, Casing Wear Ring	304SS				
358	Casing Drain Plug	Carbon Steel	Carbon Steel	316SS	Alloy 20	317SS
360P	Sideplate/Wear Ring-to-Casing Gasket	Aramid Fiber with EPDM Rubber				
370A	Hex Cap Screw, Adapter to Casing	Carbon Steel				
409	Radial Bearing	Cylindrical Roller <sup>2</sup> Single Row Deep Groove <sup>3</sup>				
412A	O-ring, Impeller	Teflon <sup>®</sup>				
412C	O-ring, Sideplate-to-Casing	Viton <sup>®</sup>				
412F	O-ring, Sleeve	Teflon <sup>®</sup>				
444	Backplate (Dynamic Seal Option)	316SS	316SS	316SS	CD4MCuN	317SS
496	O-ring, Bearing Housing	Buna				
748	Casing Lug <sup>2</sup>	Ductile Iron				
761B	i-ALERT Condition Monitor	Stainless Steel/Epoxy				

Notes: <sup>1</sup>Shearpeller™ available only in Duplex 2205. <sup>2</sup>Available on S, M, L, XL only <sup>3</sup>Available on XL1, XL2-S, XL2 only

## Materials of Construction

Material	Approximate Equivalent Standards			
	ASTM	DIN	JIS	ISO
Ductile Iron	A536 Gr 60-40-18	0.7043	G5502 FCD40	R1083/400-12
Cast Iron	A48 Class 30B	0.6020	G551 FC20	DR185/Gr200
316SS	A743 CF-8M	1.4408	G5121 SCS14	
317SS	A743 CG-8M	1.4448		
CD4MCuN	A890 GR1B CD4MCuN	1.4517		
Alloy 20	A743 CN-7M	1.4536		
Duplex 2205	A240	1.4462		

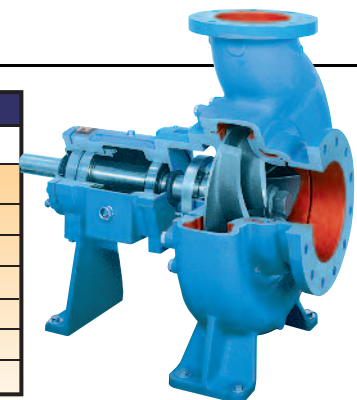

## Sectional View S, M, L and XL

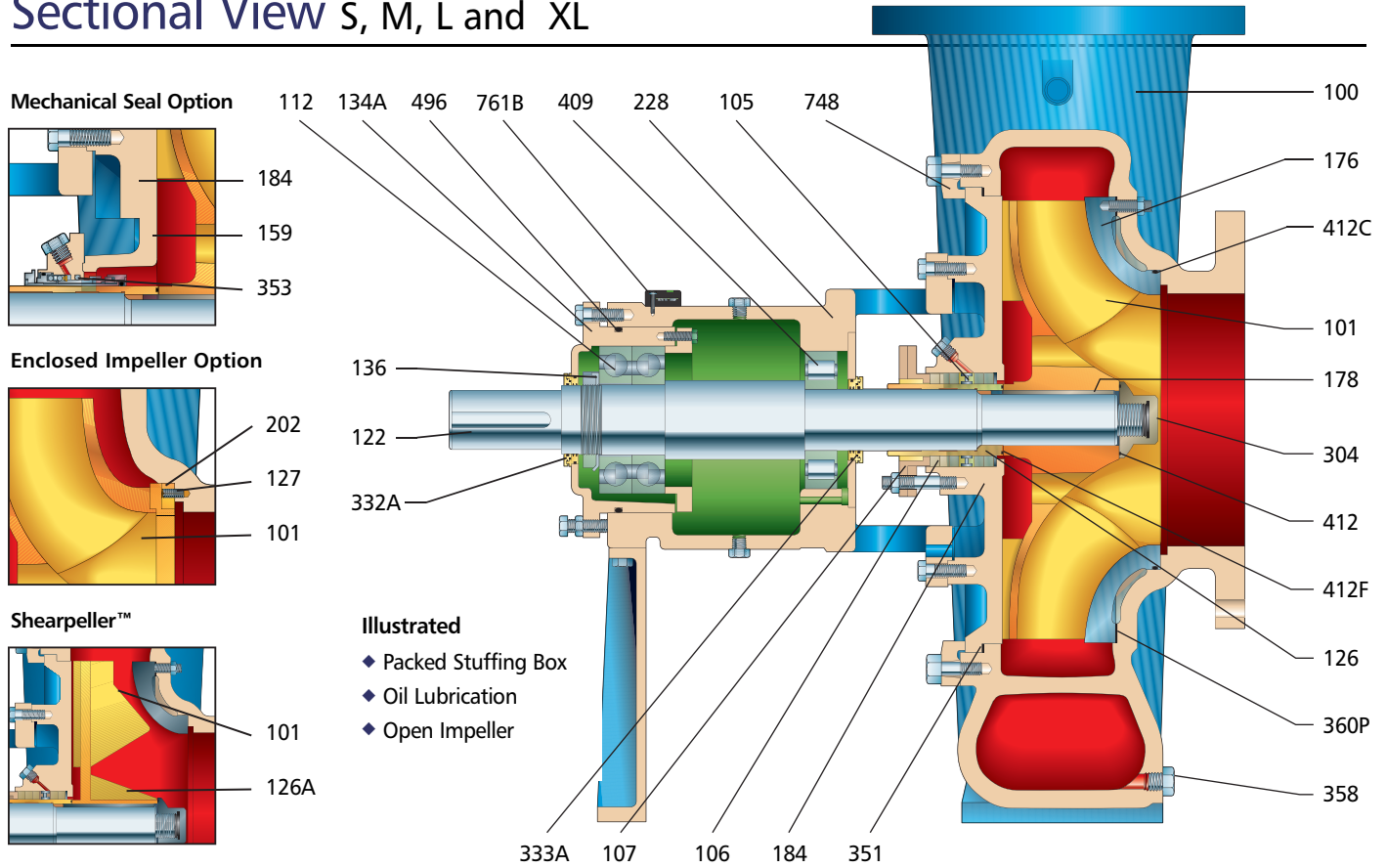

## Sectional View XL1, XL2-S and XL2

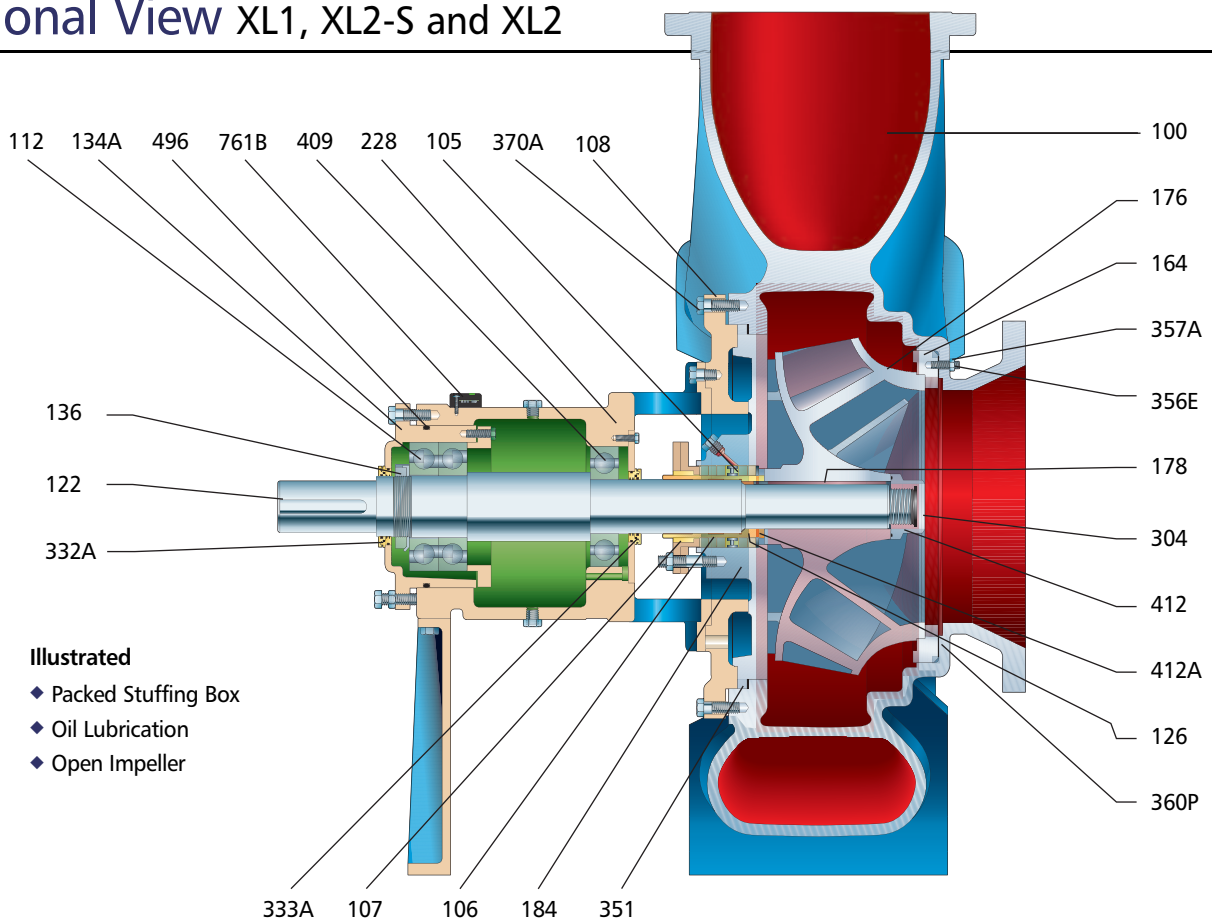

Dimensions Model 3180i-ALERT™ All dimensions in inches and (mm). Not to be used for construction.

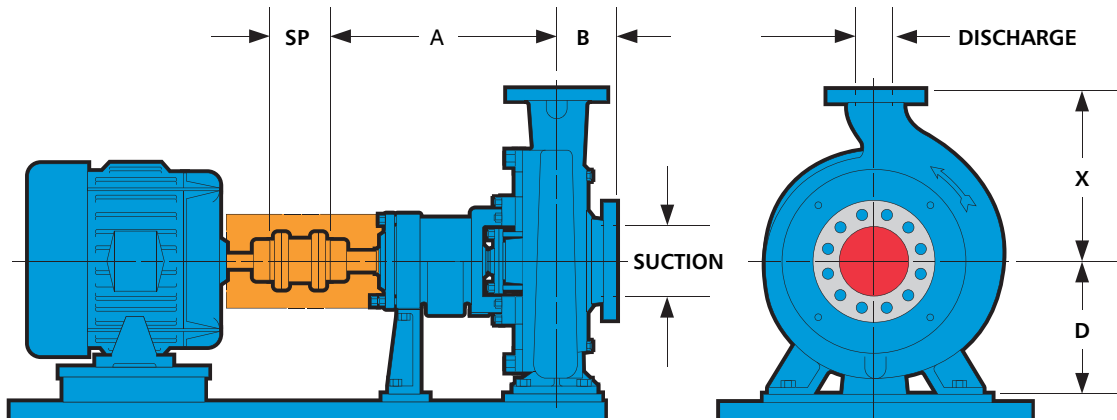

DIMENSIONS									
Group	Size	Discharge	Suction	D	X	B	A	SP (minimum)	Pump Weight-Pounds
S	3X6-12	3	6	9.84	12.40	4.92	20.87	5.51	368
	4X6-12	4	6	9.84	13.98	5.51	20.87	5.51	389
	6X8-12	6	8	11.02	14.76	6.30	20.87	5.51	520
	8X8-12	8	8	12.40	16.73	7.87	20.87	5.51	650
	3X6-14	3	6	9.84	12.40	4.94	20.87	5.51	468
	4X6-14	4	6	11.02	13.98	5.51	20.87	5.51	503
	4X6-16	4	6	12.40	15.75	5.51	20.87	5.51	566
M	6X8-14	6	8	12.40	15.75	6.30	26.38	7.09	545
	8X8-14	8	8	12.40	17.72	7.09	26.38	7.09	620
	10X10-14	10	10	13.98	18.70	8.86	26.38	7.09	773
	12X12-14	12	12	16.73	22.05	9.84	26.38	7.09	922
	6X8-16	6	8	12.40	17.72	6.30	26.38	7.09	626
	4X6-19	4	6	12.40	16.73	6.30	26.38	7.09	672
L	6X10-16	6	10	13.98	19.69	7.09	29.53	7.09	821
	8X10-16	8	10	16.73	19.69	8.86	29.53	7.09	913
	10X12-16	10	12	16.73	23.62	10.43	29.53	7.09	1077
	14X14-16	14	14	19.69	26.38	11.04	29.53	7.09	1336
	4X8-19	4	8	13.98	17.72	6.30	29.53	7.09	700
	6X10-19	6	10	13.98	19.69	7.09	29.53	7.09	926
	8X10-19	8	10	16.73	22.05	7.87	29.53	7.09	994
	10X12-19	10	12	16.73	23.62	9.84	29.53	7.09	1133
	6X10-22	6	10	16.73	22.05	7.09	29.53	7.09	1087
	8X10-22	8	10	16.73	23.62	8.86	29.53	7.09	1198
XL	12X14-19	12	14	19.69	26.38	11.02	32.68	9.84	1538
	16X16-19	16	16	22.05	29.53	11.81	33.46	9.84	1846
	10X12-22	10	12	19.69	26.38	8.86	32.68	9.84	1451
	12X14-22	12	14	22.05	26.38	10.43	32.68	9.84	1682
	14X16-22	14	16	24.80	29.53	13.19	32.68	9.84	2018
	18X18-22	18	18	24.80	33.46	13.98	33.46	9.84	2321
	6X10-25	6	10	16.73	22.05	7.87	32.68	9.84	1389
	8X12-25	8	12	19.69	24.80	8.86	32.68	9.84	1515
	10X14-25	10	14	22.05	29.53	9.84	32.68	9.84	1688
	20X20-25	20	20	29.53	39.37	15.75	33.46	9.84	2681
XL1	24X24-27	24	24	33.46	43.13	19.37	49.25	18	6040
	20X24-29	20	24	31.02	42.12	17.50	49.75	17	6525
XL2-S	20X24-31	20	24	33.47	43.31	17	56.25	17	7066
XL2	24X30-35	24	30	37.80	51.18	21.25	57.41	21	11,725
	30X30-41	30	30	43.31	67	24	58.16	24	15,525



# Construction Details (English Dimensions)

		S Group	M Group	L Group	XL Group
Temperature Limits	Grease Lube	355° F	355° F	355° F	355° F
	Oil Lube w/o cooling	355° F	355° F	355° F	355° F
	Oil lube w/cooling	445° F	445° F	445° F	445° F
Shaft Diameters (inches)	At Impeller	1.51	1.77	2.20	2.60
	Under Shaft Sleeve	1.97	2.28	2.68	3.15
	At Coupling	1.625	1.875	2.375	2.875
	Between Bearings	2.63	2.88	3.39	4.06
Packed Stuffing Box (inches)	Bore	3.35	3.74	4.13	4.72
	Depth	3.35	3.35	3.54	3.54
	Packing Size	1/2	1/2	1/2	1/2
	# of Packing Rings	5	5	5	5
	Width of Lantern Ring	5/8	5/8	3/4	3/4
	Distance to 1st Obstruction	2.26	3.14	2.76	3.24
	Sleeve Diameter	2.362	2.756	3.150	3.738
Mechanical Seal Chamber (inches)	Bore	3.37	3.88	4.49	5
	Depth to VPE ring	1.81	2.40	2.15	2.15
	Distance to 1st Obstruction	2.89	3.64	3.46	3.98
	Sleeve Diameter	2.375	2.75	3.25	3.75

		XL1 Group		XL2-S Group	XL2 Group	
		20X24-29	24X24-27	20X24-31	24X20-35	30X30-41
Temperature Limits	Oil Lube w/o cooling	355° F				
	Oil Lube w/cooling	445° F				
Shaft Diameters (inches)	At Impeller	3.937			4.921	
	Under Shaft Sleeve	4.625		5.750		
	At Coupling	4.125		5.125		
	Between Bearings	5.51		6.69		
Packed Stuffing Box (inches)	Sleeve Diameter	5.315		6.496		
	Bore	6.30		7.48		
	Depth	3.54		3.54		
	Packing Size	1/2 X 1/2		1/2 X 1/2		
	# Of Packing Rings	5		5		
	Width of Lantern Ring	3/4		3/4		
	Dist. to 1st Obstruction	7.33		8.70		
Mechanical Seal Chamber (inches)	Sleeve Diameter	5.250		6.250		
	Depth	3.06		3.16		
	Dist. to 1st Obstruction	7.33		8.70		
TaperBore™ Seal Chamber (inches)	Bore	6.69		7.87		
	Depth to VPE Ring	5.25		5.75		
	Dist. to 1st Obstruction	6.10		6.82		
	Depth to VPE Ring	4.00		4.50		

# Modular Interchangeability

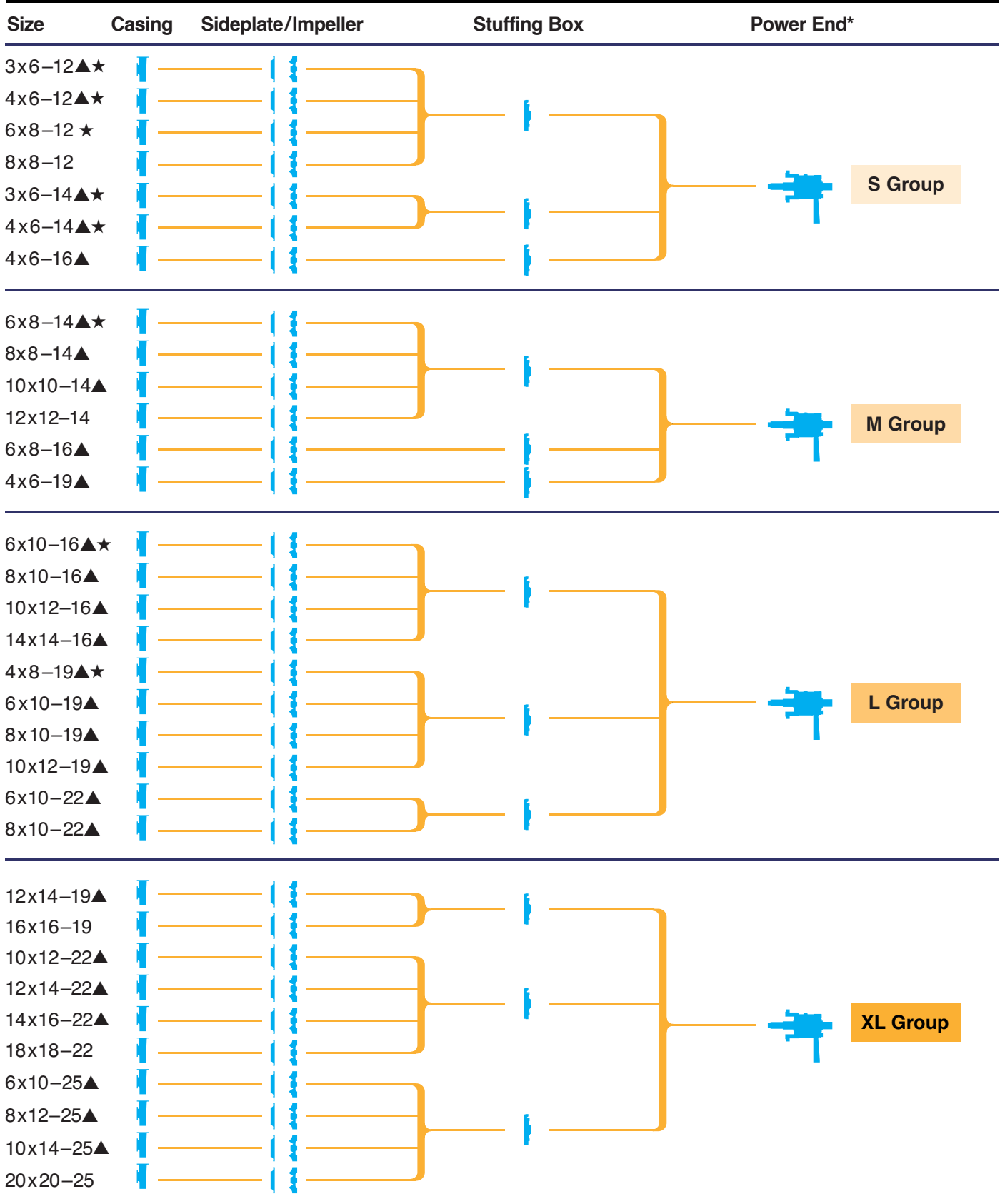

# Modular Interchangeability

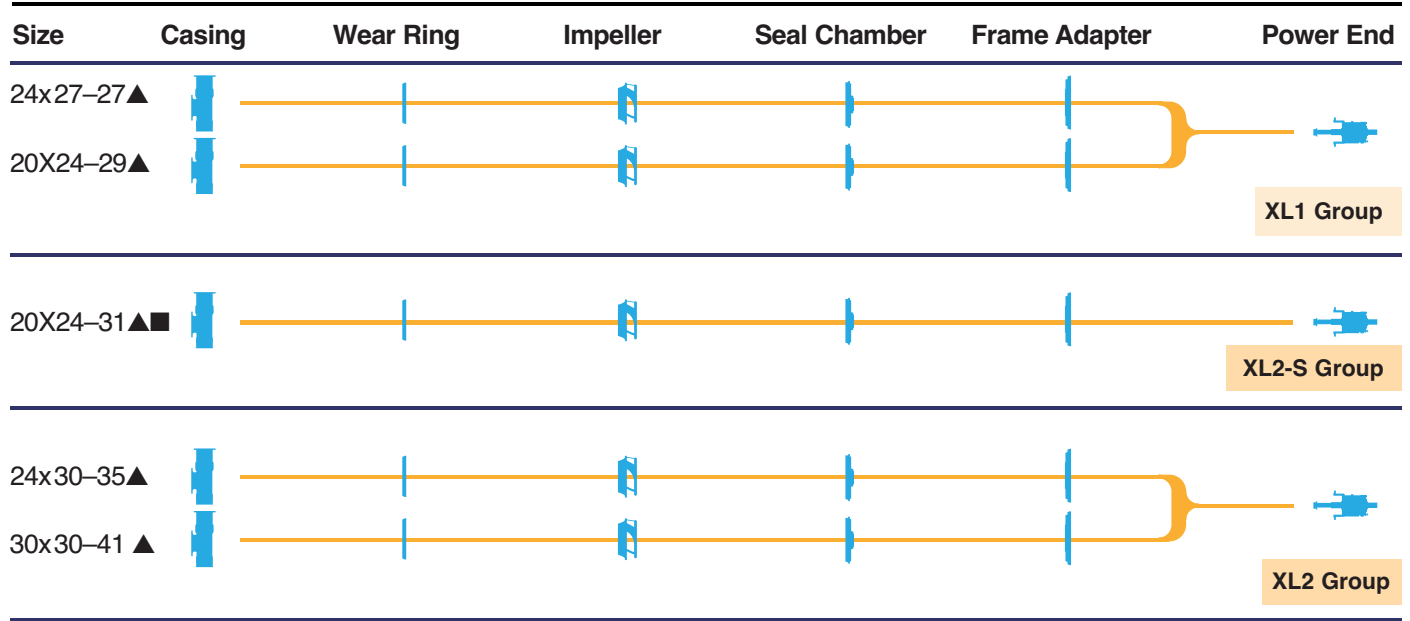

\* Shafts for Models 3180 and 3185 are not interchangeable.  
 Sleeves for mechanical seals on the 3180 and 3185 are not interchangeable.  
 ▲ Available with enclosed impeller.

★ Available with Shearpeller™  
 ■ Uses the XL2-S shaft, sleeve and impeller nut.

## Pick Your Perfect Process Pump

No one in the industry offers the broad range of process pumps that Goulds does!

Whether it's for pumping severe corrosives, abrasive slurries, fibrous/stringy solids, high temperature liquids, hazardous fluids, low flow or high capacity services — Goulds has a perfect, reliable solution. The Goulds selection of pump solutions includes horizontal and vertical configurations in a range of alloy and non-metallic constructions, sealed and sealless.

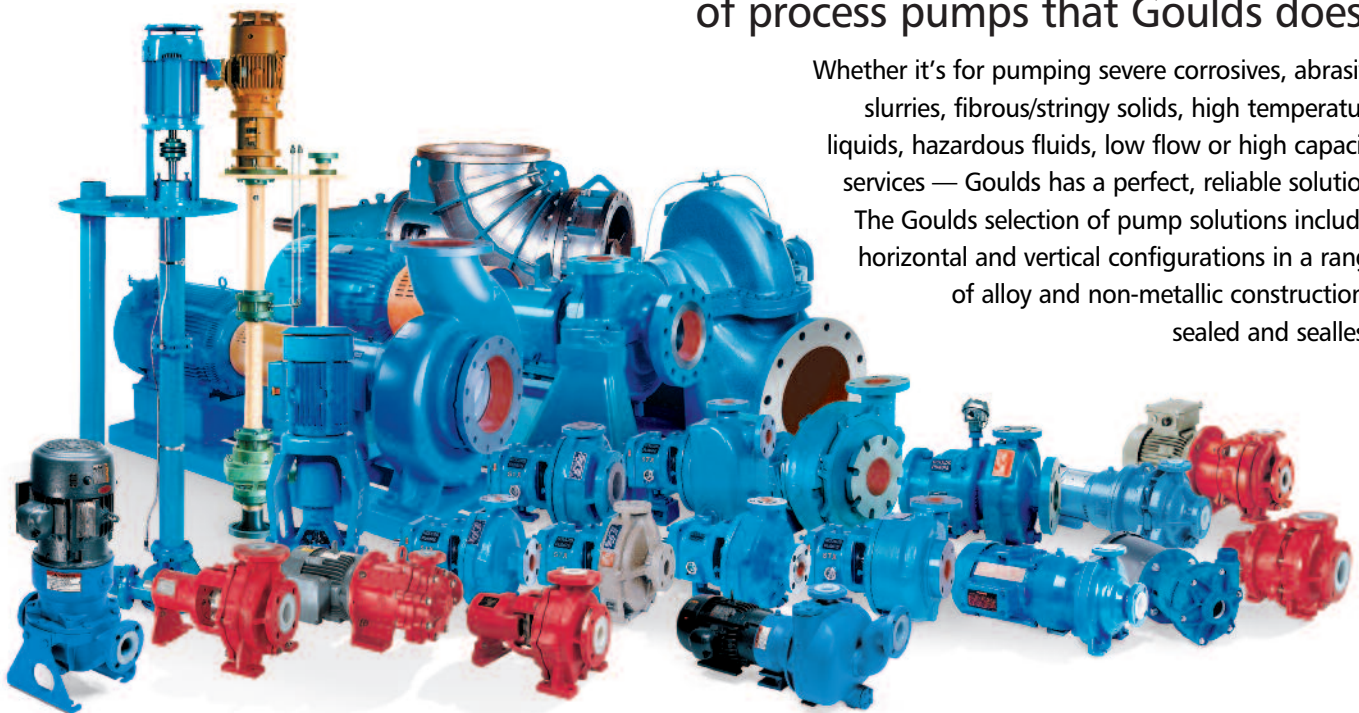



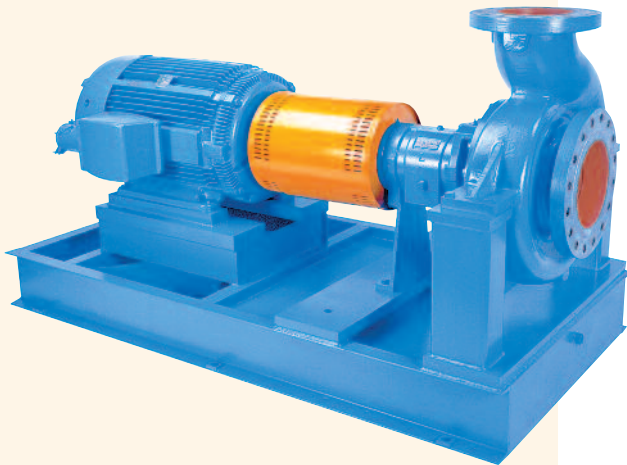

- ◆ Capacities to 13,000 GPM (3,000 m<sup>3</sup>/h)
- ◆ Heads to 410 feet (125 m)
- ◆ Temperatures to 508°F (300°C)
- ◆ Pressures to 360 PSIG (25 bar)

## World-class pump line

### Model 3181

- ◆ ANSI Class 300 flange drilling
- ◆ Inch-dimensioned O.D. of mechanical seal sleeve
- ◆ Inch-dimensioned bearing locknut
- ◆ Inch-dimensioned coupling extension

### Model 3186

- ◆ ISO or JIS 40 bar flange drilling
- ◆ mm-dimensioned O.D. of mechanical seal sleeve
- ◆ mm-dimensioned bearing locknut
- ◆ mm-dimensioned coupling extension

## Goulds 3181/3186

Designed to handle high temperature and high pressure services of the pulp & paper industries

- ◆ **Hydraulic Coverage** – Line designed for full 50/60 Hz performance.
- ◆ **Back Pull-out Construction** – Spacer type coupling allows one-craft maintenance.
- ◆ **Centerline Supported** – High temperature stability.
- ◆ **Labyrinth Seals** – Eliminate loss of lubricant, prevent lubricant contamination for maximum bearing life.
- ◆ **Maximum Interchangeability** – Power end and impellers completely interchangeable with Goulds Models 3180 or 3185.
- ◆ **International Design** – Metric fasteners and fittings used throughout.

## Services

- ◆ Digester recirculation
- ◆ Make-up liquor
- ◆ White liquor
- ◆ Black liquor
- ◆ High pressure/high temperature pulp mill services
- ◆ Hot oil

## Model 3181/86

For high pressure/temperature services

- ◆ Centerline mounted
- ◆ Fully-confined spiral wound-casing basket
- ◆ Through bolted seal chamber

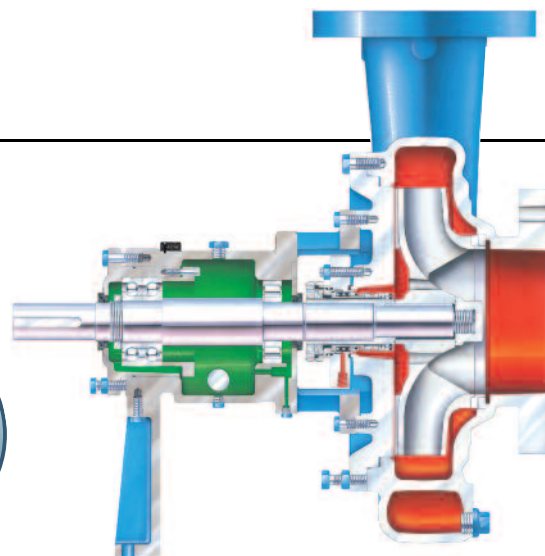



## World-class Paper Stock and Medium Consistency Products

Goulds offers a variety of products in various configurations to meet your medium consistency pumping and mixing needs

### Standpipe Arrangement with ClO<sub>2</sub> Mixing

Stock from washers and mixers feed special Goulds standpipes that are reverse tapered to prevent stock bridging. Systems include controls for vacuum, dilution, level and flow, ClO<sub>2</sub> Optimix™ mixer and chemical injection pipe are included.

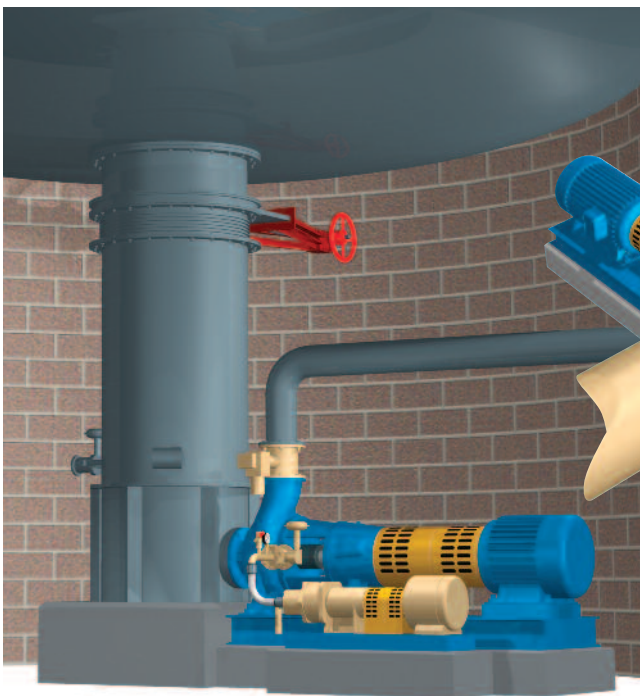
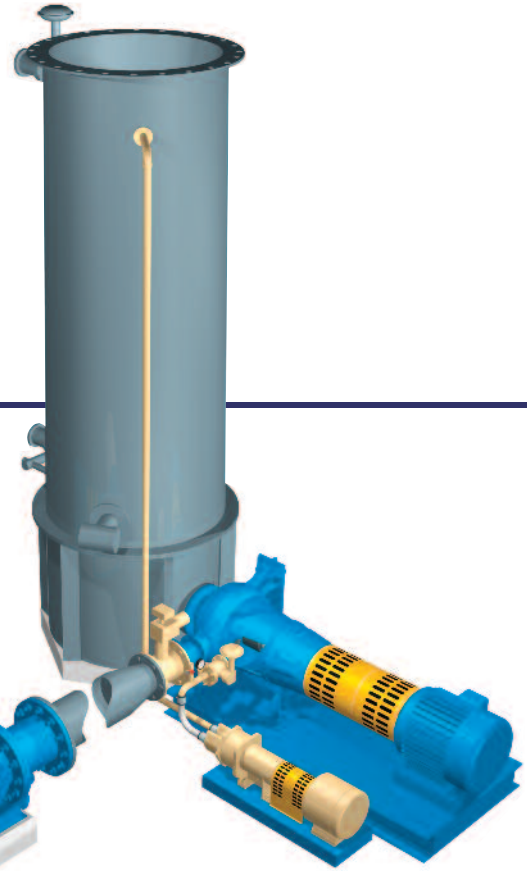

### Tower Bottom Arrangement

Stock from bleach / storage towers falls into Goulds feed chute connected to the tower with expansion joint and isolation valve. Depending on tower level and consistency a vacuum pump may not be required.

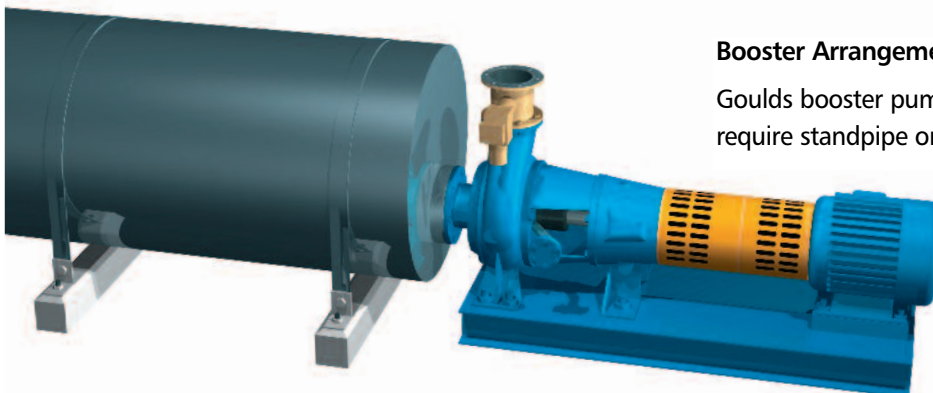

### Booster Arrangement

Goulds booster pump will increase pressure, but does not require standpipe or degassing system.



## PRO Services® Extending Equipment Life...

### Product Repair

- Service Center Repair
- Turnkey Repair/ Installation
- Field Service
- Emergency Service

### Reliability Improvement

- Predictive Condition Monitoring
- Root Cause Failure Analysis
- Machine & System Assessment
- Engineered Upgrades
- Training

### Optimization of Assets

- Inventory Management
- Replacement/Exchange
- Maintenance Management
- Contract Maintenance

- 
- All Brands
  - Factory Trained Service Personnel
  - Quality
  - Fast Turnaround
  - Emergency Service – 24 hours/day, 7 days/week
  - ISO and Safety Certified

## PROSMART

ProSmart® provides continuous machinery monitoring to identify little problems before they become big problems...like downtime. Using wireless technology, advanced signal processing capabilities, and easy-to-deploy sensors, ProSmart offers an affordable means to monitor all of your rotating equipment anywhere in the world.



By identifying and alerting you to changes in operating conditions, ProSmart increases your time to respond to either correcting the upset condition, or properly plan its repair.

### Key Features include:

- **Continuous data acquisition and analysis** – ProSmart collects vibration, temperature, and available process conditions every five seconds; saving you time from routine data collection.
- **Automatic notification and accessibility** – By alerting when a machine goes into distress, you are able to focus your resources on recovery activities. The ProNet web-hosted solution allows access to information anywhere in the world through a standard Internet browser connection.
- **Advanced diagnostic tools** – More than simple overall data, ProSmart provides advanced analysis capabilities such as time-waveform, spectral, and spectral windowing.
- **Easy to deploy** – Using plug and play sensors, wireless connectivity, and an industrially hardened enclosure, ProSmart can be easily deployed throughout your plant, including hazardous areas.

## PUMPSMART

PumpSmart® is the latest advancement in pump control and protection to reduce energy consumption, increase uptime and decrease maintenance cost. It allows the pump to be right-sized to the application by dialing in the speed and torque which increases flow economy, reduces heat and vibration, and improves overall system reliability.

- **Simplified Pump Control** – PumpSmart was designed specifically to optimize pumping applications and can be used to control a single pump or coordinate between multiple pumps without the need for an external controller.
- **Pump Protection** – PumpSmart guarantees to protect the pump from upset conditions with patented sensorless pump protection algorithms.
- **Smart Flow** – PumpSmart features a sensorless flow function for centrifugal pumps that can calculate the flow of the pump within ± 5% of the pump rated flow.
- **Drive for the DCS** – While most VFDs can only provide basic information, PumpSmart offers unparalleled insight to the pump operation which allows for smoother process control and efficiency.
- **Pump Experts** – PumpSmart is a variable speed drive with pump-specific algorithms imbedded into the drive. With over 150 years of pump knowledge, let the pump experts take responsibility of your pump system.

