



ITT

Goulds Pumps

Goulds NM3196 *i-FRAME*TM

FRP Process Pumps

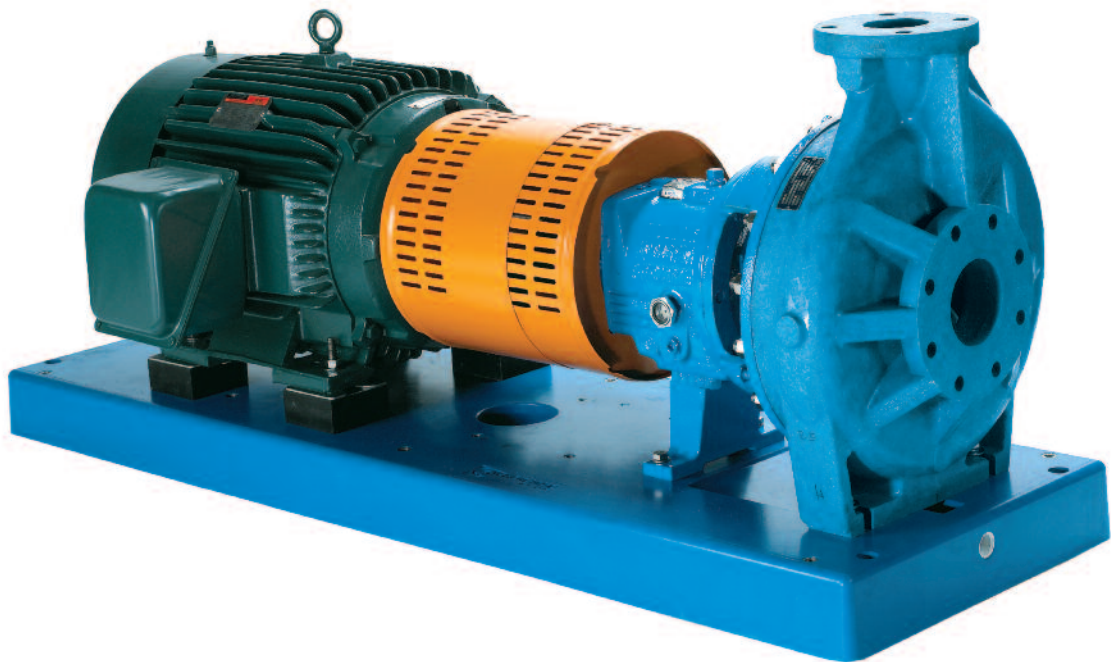

Engineered for life

motralec

4 rue Lavoisier . ZA Lavoisier . 95223 HERBLAY CEDEX
Tel. : 01.39.97.65.10 / Fax. : 01.39.97.68.48
Demande de prix / e-mail : service-commercial@motralec.com
www.motralec.com

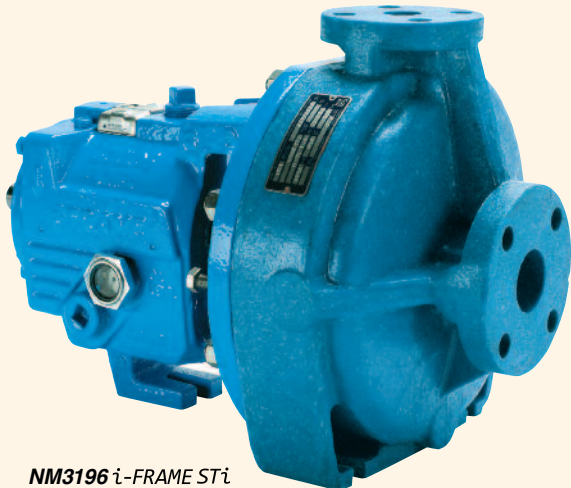

NM3196 *i-FRAME* STi

The NM3198 *i-FRAME* FRP process pump line is designed specifically to provide superior performance for the corrosive services of the Chemical Process Industries.



NM3196 *i-FRAME* MTi

Goulds NM3196 *i-FRAME*™

FRP Process Pumps Designed for Total Range of Severe Corrosive Services

- ◆ Capacities to 1400 GPM (318 m³/h)
- ◆ Heads to 500 feet (152 m)
- ◆ Temperatures to 200° F (93° C)
- ◆ Pressures to 220 PSIG (1517 kPa)

Performance Features for Severe Corrosive Services

Extended Pump Life

- ◆ Fiberglass Reinforced Vinylester Construction
 - Random fiber orientation provides strength equal to metal
 - Same flange loading capability as metallic Model 3196 *i-FRAME*
 - Superior corrosion resistance
- ◆ *i-FRAME* Power Ends
- ◆ Fully open impeller

Ease of Maintenance

- ◆ Back pull-out design
- ◆ ANSI standard dimensions
- ◆ External impeller adjustment
- ◆ Parts interchangeable with Goulds 3196 *i-FRAME*
- ◆ Easy retrofit

Optimum Hydraulic Performance

- ◆ True volute casing
- ◆ Fully open impeller

Safety

- ◆ ANSI B15.1 coupling guard
- ◆ No through-bolt fastening

Services

- ◆ Hydrochloric Acid Unloading
- ◆ Ferric chloride
- ◆ Sulfuric Acid Transfer
- ◆ Sodium Sulphite
- ◆ Sulphate Liquors
- ◆ Plating Solution
- ◆ Filter Feed
- ◆ Aquarium Water
- ◆ Sea Water

We Are Serious About Non-Metallic Pumps

Proven Corrosion Resistance

To prove that our non-metallic material will provide satisfactory performance in your specific pump application, we can provide corrosion coupons for you to test in your pumpage. We can also work with you to provide modified materials to best suit your needs. We take corrosion resistance seriously!



Superior Impeller Design

The oversized composite impeller hub is designed to provide proper torque transmission across the pump's entire operating range. The standard impeller insert is non-wetted and is made of Hastelloy-C for added strength and corrosion resistance when installed in a corrosive environment. The insert geometry is designed to have a positive lock in all directions with the non-metallic impeller. This greatly reduces damage to the impeller from over-torque or fatigue stress that might cause the impeller to separate from the insert, providing a design that has decades of proven operation.



"No Hassle" Guarantee

We are so confident that the impeller and the insert will not fail under normal operation that we back it with a 5 year "no hassle" guarantee. If your impeller insert separates from the impeller under approved and normal operating conditions, we will replace the impeller at no charge!



Casing Design

- 1 Oversized bosses for external flush, drain, and gauge connections. No need for adding external connections in the piping.
- 2 Casing fasteners are stainless steel and are threaded directly into the casing. Eliminates multiple through bolts used by others, thus reducing the complexity and the size of the casing.
- 3 True volute design for smooth laminar liquid flow providing optimum hydraulic efficiencies up to 20% better than the competition.
- 4 Machined cover bore for o-ring seal. Provides superior sealing that is not impacted by improper bolt torque or misalignment.
- 5 3-D computer modeling has been used to verify material strength and performance.

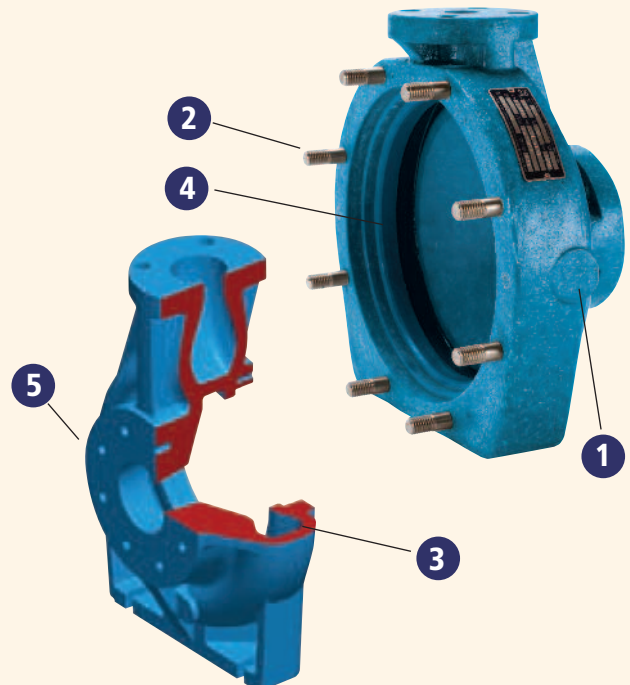

Goulds NM3196 *i-FRAME*™ Designed for Severe Corrosive Services



NM IMPELLER



ALLOY IMPELLER



i-FRAME POWER END



GLAND



BACKPLATE



IMPELLER



CASING

Goulds NM3196 *i-FRAME*...An Economical Solution

The traditional choice of pump construction for handling moderate corrosive liquids has been high alloys such as Alloy 20 and Hastelloy. Today, minimizing plant costs and maximizing equipment reliability are priorities. High alloys can be expensive and difficult to select... pump users want an alternative.

The NM3196 *i-FRAME* is an economical solution. For little more than the price of a stainless steel ANSI pump, the

NM3196 *i-FRAME* is ideally suited for corrosive services from hydrochloric acid to sulfuric acid to sodium hydroxide.

Maintenance and downtime costs require a pump to be tough and provide service and reliability under adverse conditions for extended periods of time. The NM 3196 proves itself everyday in demanding installations... standing up to tough services and lasting!

Corrosion Resistant Construction

The NM3196 casing and impeller are constructed of vinylester thermoset resin-industry's choice for moderate corrosives. Maximum strength is achieved by fiber reinforcement. No fillers are used which reduce corrosion resistance.

Goulds utilizes our proprietary process which permits a true volute to be molded in the casing, just like a metal ANSI pump. Other materials available upon request.

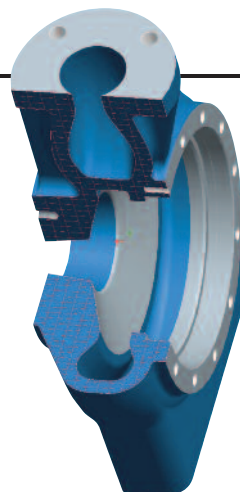

Bonus Interchangeability

i-FRAME™ Power Ends Fit 7 Different Process Pumps

Minimize inventory, reduce downtime.



3196 *i-FRAME*
Process Pumps



CV 3196 *i-FRAME*
Non-Clog
Process Pumps



HT 3196 *i-FRAME*
High Temperature
Process Pumps



LF 3196 *i-FRAME*
Low Flow ANSI
Process Pumps



3198 *i-FRAME*
PFA TEFLON®-Lined
Process Pumps



3796 *i-FRAME*
Self-Priming
Process Pumps



NM 3196 *i-FRAME*
Non-Metallic
Process Pumps

Maximum Sealing Flexibility

A wide range of sealing arrangements are readily available to meet specific user requirements. Your Goulds representative can recommend the best solution for any service. Some are illustrated here.

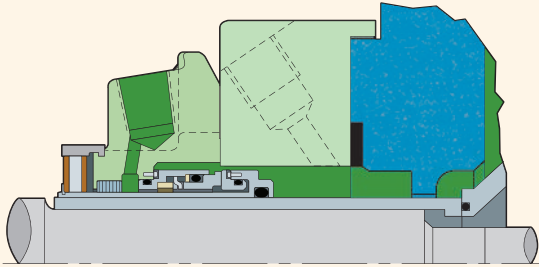

Single cartridge seal with backplate extension piece

- Accommodates a single or double cartridge seal
- Taper Bore or Big Bore seal chamber available
- Optional Big Bore with a restrictor bushing for external flush

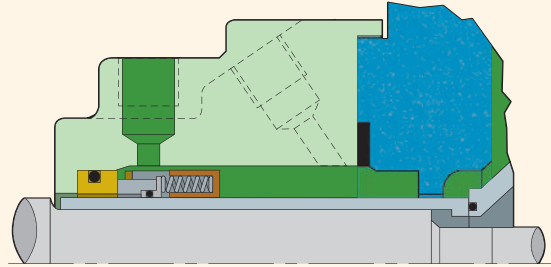

Single conventional seal with seal chamber extension

- Accommodates a conventional single seal
- FRP seal chamber extension for optimum corrosion resistance
- Optional restrictor bushing for use with external flush

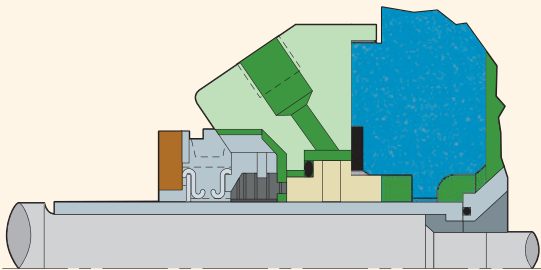

Single outside seal with clamped seat

- Most used configuration
- Clamped stationary seat with flush connection
- Non-wetted FRP gland for added corrosion resistance

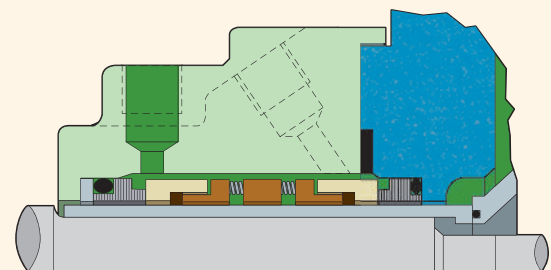

Double conventional seal with seal chamber extension

- Accommodates a conventional double seal
- FRP seal chamber extension for optimum corrosion resistance

Sealless Solutions

Not all process pump applications can be sealed with optimum reliability. Goulds ANSI dimensional magnetic drive sealless process pumps are perfect solutions to mechanical seal or environmental sealing problems. The 3296 EZMAG metal magnetic drive process pump has a revolutionary bearing cartridge design for maximum reliability and ease of maintenance. For tough corrosive services Goulds also offers ETFE and PFA-lined magnetic drives available in horizontal, vertical or self-priming configurations to meet all your process needs.

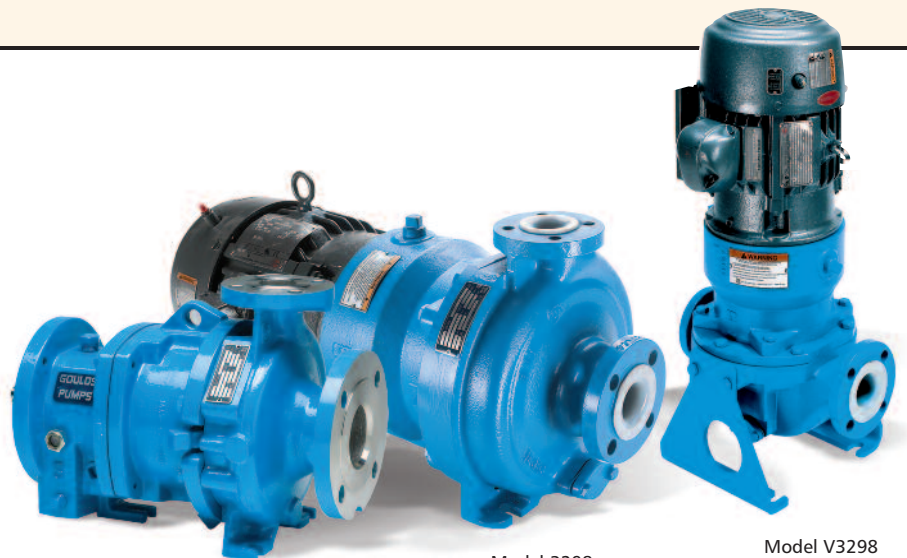

Model 3296 EZMAG

Model 3298

Model V3298



NM3196 *i*-FRAME™ FRP Process Pumps Design Features for Wide Range of Severe Corrosive Services

CONDITION MONITOR

Constantly measures vibration and temperature at the thrust bearing. Colored LED's indicate general pump health. Provides early warning of improper operation before catastrophic failure occurs.

INPRO VBXX-D HYBRID LABYRINTH SEALS

Prevents premature bearing failure caused by lubricant contamination or loss of oil. Stainless steel rotors for optimal performance in corrosive environments

CONTINUOUS HIGH PERFORMANCE

Original high efficiency maintained by simple external adjustment resulting in long-term energy savings.

HEAVY DUTY SHAFT AND BEARINGS

Shaft designed for minimum deflection – less than .002 in. (.05 mm) – at seal faces. Bearings sized for 2-year minimum and 10-year average life under tough operating conditions.

ONE-INCH OIL SIGHT GLASS

For easy monitoring of actual oil level and condition.

SHAFT SEALING

Goolds NM3196 is available with backplate, stuffing box, TaperBore, or BigBore™ seal chamber. Accommodates conventional single inside, single outside, and double mechanical seals. TaperBore and BigBore™ seal chamber accommodates cartridge single and double seals.

RIGID FRAME (AND CASING) FEET

Reduce the effect of pipe loads on alignment.

i-FRAME POWER END

Designed for reliability and extended pump life, backed with a 5-year warranty.

POSITIVE POWER END ALIGNMENT

Provided by accurate machined fits and face-to-face mounting with casing.

CONTROLLED COMPRESSION GLAND SEALING

Face-to-face contact eliminates overtorquing and gland distortion, two primary causes of mechanical seal failures

HIGH-PERFORMANCE VOLUTE DESIGN

High-efficiency, true volute design achieved by exclusive Goolds Molding Process. Unlike other designs, efficiencies comparable to cast alloy ANSI pumps.

ONE-PIECE RIBBED CASING

Ribs provide maximum support to resist casing distortion and withstand flange loading. No need for expansion joints to reduce pipe loads as NM 3196 loading same as Model 3196.

Casing stud design eliminates need for through bolt fastening — allows complete interchangeability with 3196 casings.

REINFORCED VINYLESTER CONSTRUCTION

Unique high-strength molded material combines high-corrosion resistance and temperature capabilities with enhanced strength properties attained by Goolds Molding Process.

POSITIVE SEALING AT CASING JOINT

Provided by rugged, thick cross-section Viton O-ring. Teflon encapsulated Viton optional..



FULLY OPEN IMPELLER

Acknowledged best design for chemical services — solids handling, stringy material, corrosives, abrasives. Back pump-out vanes minimize seal chamber pressure.

Impeller insert assures maximum mechanical integrity, provides uniform low-stress torque transfer and maximum FRP material support. Assures close tolerance impeller-to-shaft alignment and fit. Metal to metal impeller drive.

Goulds Patented *i-FRAME*™ Power Ends

Extended Pump Life Through Intelligent Design

Goulds *i-FRAME* Power Ends are the result of 160 years of design experience, customer interaction, and continuous improvement. Customers get extended Mean Time Between Failure (MTBF) and lower life cycle costs (LCC)... guaranteed!

Condition Monitor



The heart of the *i-FRAME*™, the condition monitor unit continuously measures vibration and temperature at the thrust bearing and automatically indicates when pre-set levels of vibration and temperature have been exceeded, so that changes to the process or machine can be made before failure occurs.

A visual indication of pump health makes walk-around inspections more efficient and accurate. The result is a more robust process to monitor and maintain all your ANSI pumps so that your plant profitability is maximized.

A reliability program centered around walk-arounds captures equipment condition on average once a month; the failure process, however, can begin and end quite frequently within this time period.



Shaft and Bearings Engineered for Maximum Reliability

Premium severe-duty thrust bearings increase bearing fatigue life by 2-5X.

The rugged shaft and bearing combination maintains shaft deflection of less than 0.002 inches at all operating points. The result is longer seal and bearing life.

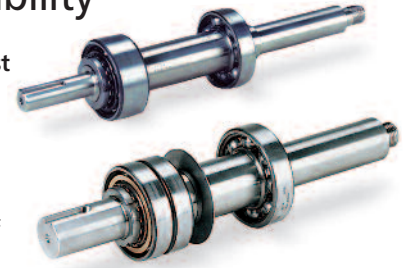

Fatigue life *more than double* that of conventional bearing steels.

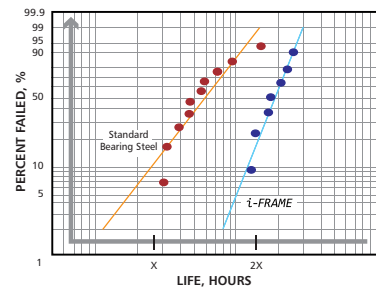
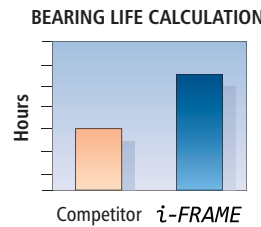

Inpro VBXX-D Hybrid Bearing Isolators

Most bearings fail before reaching their potential life. They fail for a variety of reasons, including contamination of the lubricant. INPRO VBXX-D has long been considered the industry standard in bearing lubricant protection. The *i-FRAME* now improves upon that design by offering stainless steel

rotors, for maximum protection against contaminants and the corrosive effects of seal leakage or environmental conditions. These seals are non-contacting and do not wear.

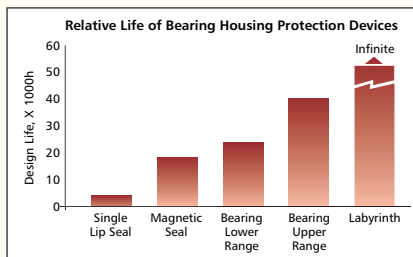
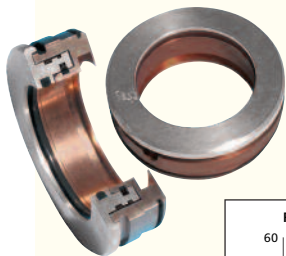

Optimized Oil Sump Design

Internal sump geometry is optimized for longer bearing life. Sump size increased by 10%-20% results in better heat transfer and cooler bearings. Contoured design directs contaminants away from bearings, to the magnetic drain plug for safe removal.

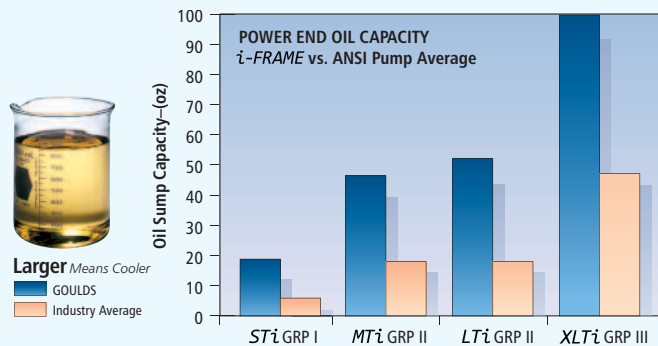
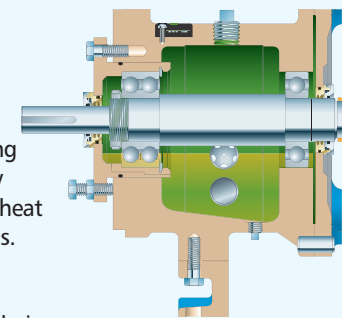

Hydraulic Coverage NM3196 *i*-FRAME™

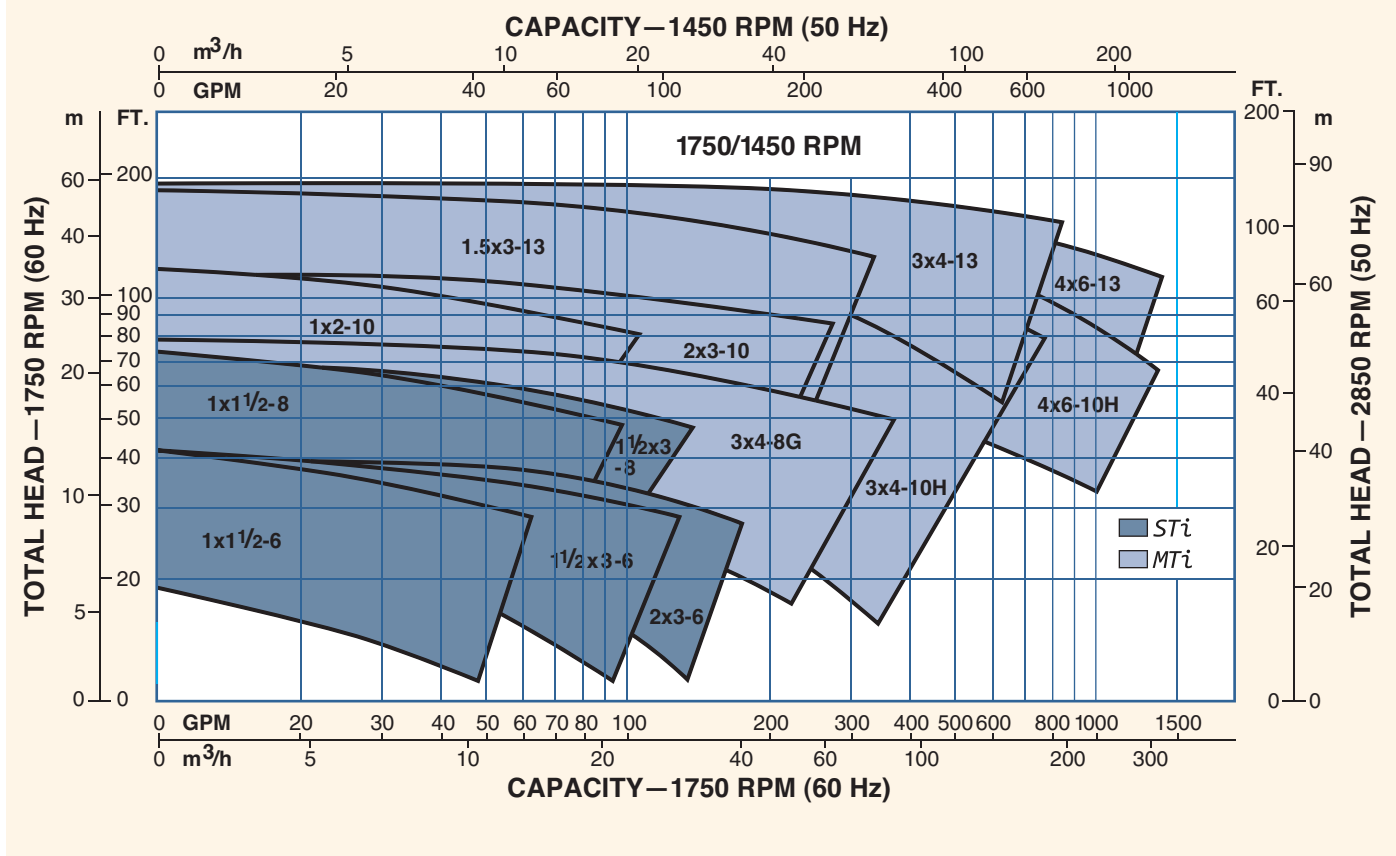
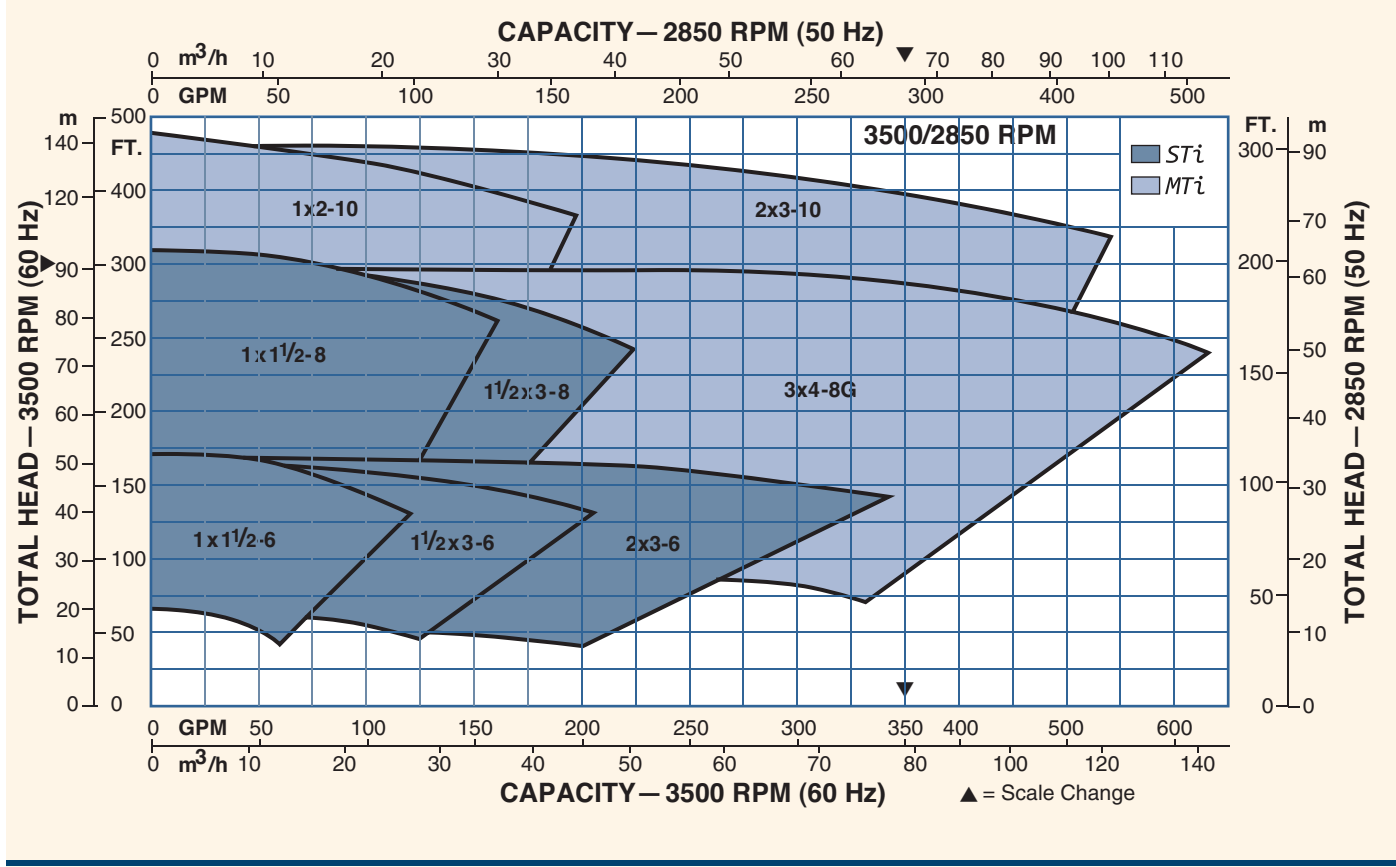

Sectional View NM3196 *i*-FRAME™

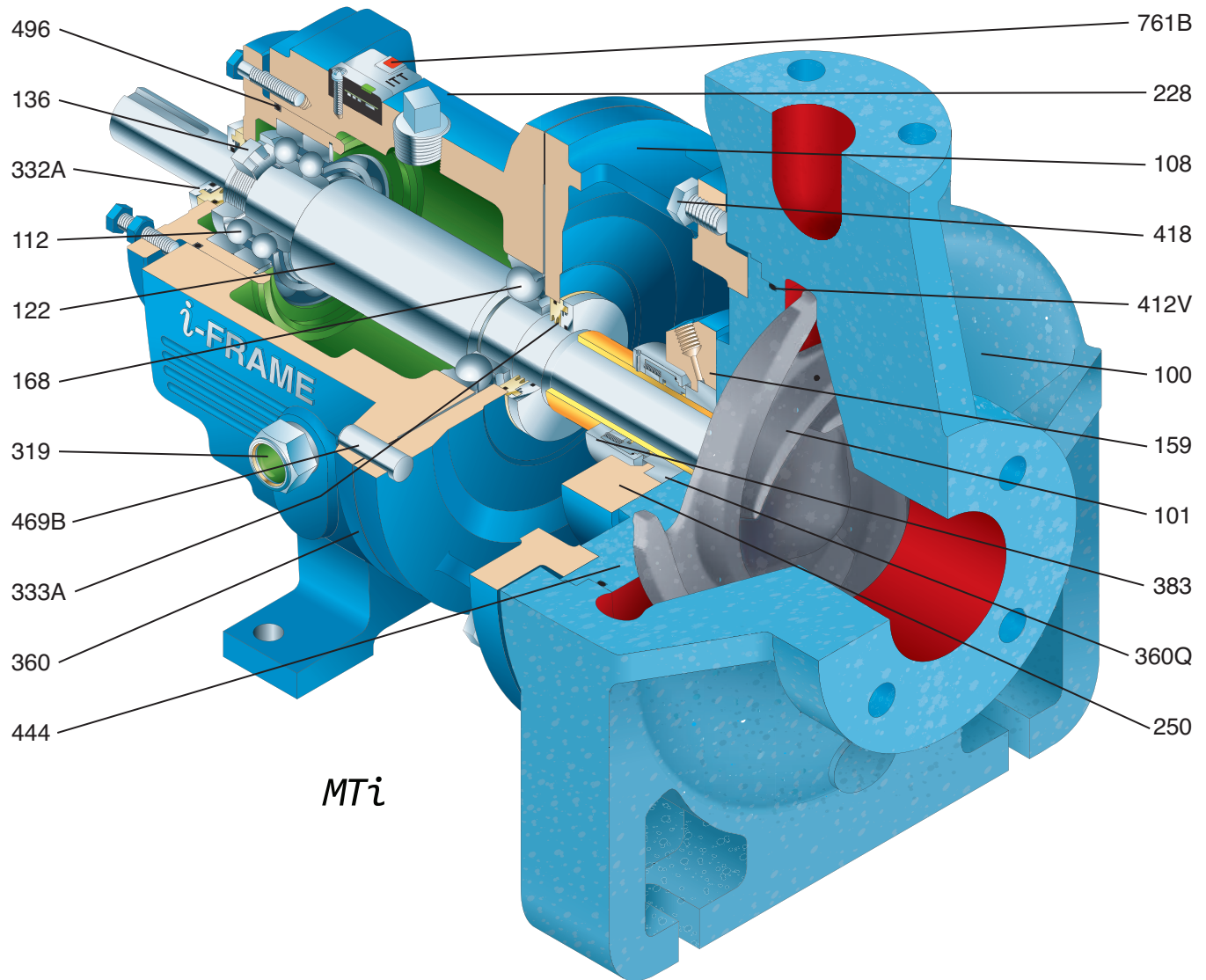

STi

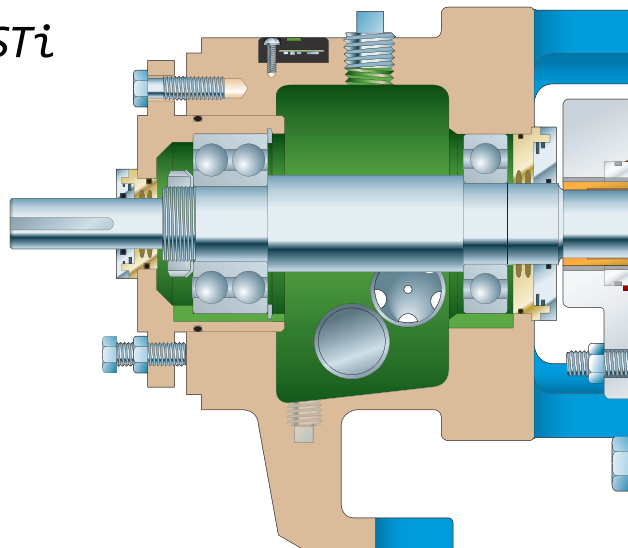

Parts List and Materials of Construction

Item Number	Part Name	Material
100	Casing	Fiberglass Reinforced Vinylester
101	Impeller (with insert)	Fiberglass Reinforced Vinylester (Hastelloy)
108	Frame Adapter	Ductile Iron
112	Thrust Bearing	Double Row Angular Contact Conrad
122	Shaft	SAE 4140 (Standard) Optional: 316SS, Alloy 20, Hastelloy B & C
126	Shaft Sleeve	Choice: FRP, 316SS, Alloy 20, Hastelloy B & C, Titanium, Zirconium
136	Bearing Locknut and Washer	Steel
159	Seal Chamber (Optional)	Fiberglass Reinforced Vinylester
168	Radial Bearing	Single Row Deep Groove
228	Bearing Frame	Cast Iron (Ductile Iron for STX Group)
250	Gland	Fiberglass Reinforced Vinylester
319	Oil Sight Glass	Glass/Steel
332A	Labyrinth Seal (Outboard)	Bronze (ASTM)
333A	Labyrinth Seal (Inboard)	Bronze (ASTM)
356A	Stud-Casing to Frame or Frame Adapter	316SS
360	Gasket, Frame to Adapter	Vellumoid
360Q	Gland Gasket	Viton A (Teflon Optional)
370H	Stud and Nut—Backplate/Frame or Frame Adapter	304SS
383	Mechanical Seal	(As Specified)
412A	O-ring—Impeller	Viton A (Teflon Optional)
412V	O-ring—Casing/Backplate	Viton A (Teflon Optional)
418	Jacking Bolt	304SS
444	Backplate	Fiberglass Reinforced Vinylester
469B	Dowel Pin	Steel
496	O-ring—Bearing Housing	Buna Rubber
496A	O-ring—Impeller	PFA Teflon®
761B	Condition Monitor	Stainless Steel/Epoxy

Construction Details All dimensions in inches and (mm).

		NM3196 STi	NM3196 MTi
Shaft	Diameter at Impeller	.75 (19)	1 (25)
	Diameter in Seal Chamber (Less Sleeve)	1.375 (35)	1.75 (45)
	(With Sleeve)	1.125 (29)	1.5 (38)
	Diameter Between Bearings	1.5 (38)	2.125 (54)
	Diameter at Coupling	.875 (22)	1.125 (29)
	Overhang	6.125 (156)	8.375 (213)
	Maximum Shaft Deflection	0.002 (0.05)	
	Sleeve	O.D. thru Seal Chamber	1.375 (35)
Bearings	Radial	6207	6309
	Thrust	3306	5306
	Bearing Span	4.125 (105)	6.75 (171)
	Average L'10 Bearing Life	87,600 hours	
Seal Chamber	Bore	2.07 (53)	2.57 (65)
Power Limits	HP (kW) per 100 RPM	1.1 (.82)	3.4 (2.6)
Maximum Liquid Temperature	Oil/Grease Lubrication	200° F (93° C)	
Casing	Corrosion Allowance	.125 (3)	

Dimensions Model NM3196 *i-FRAME*™ All dimensions in inches and (mm). Not to be used for construction.

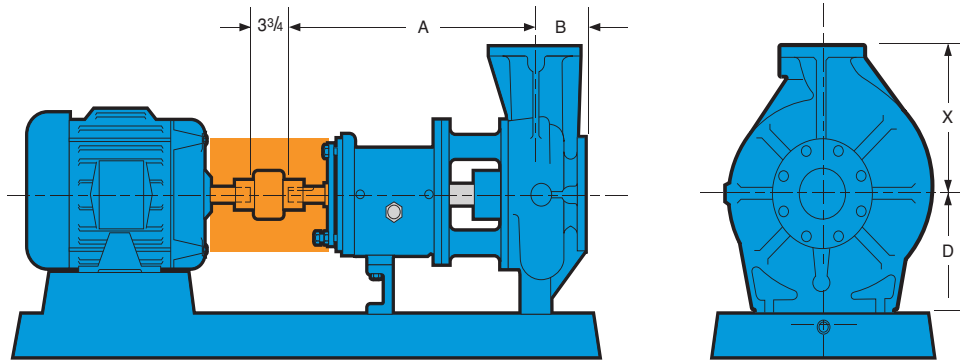

DIMENSIONS									
Group	Pump Size	ANSI Designation	Discharge	Suction	A	B	D	X	Bare Pump Weight Lbs. (kg)
STi	1x1½-6	AA	1	1½	13½ (343)	4 (102)	5¼ (133)	6½ (165)	55 (25)
	1½x3-6	AB	1½	3					57 (26)
	2x3-6	AC	2	3					57 (26)
	1x1½-8	AA	1	1½					67 (30)
	1½x3-8	AB	1½	3					69 (31)
MTi	3x4-8G	A70	3	4	19½ (495)	4 (102)	8¼ (210)	11 (279)	140 (64)
	1x2-10	A05	1	2				8½ (216)	155 (70)
	2x3-10	A60	2	3				9½ (241)	160 (73)
	3x4-10H	A40	3	4			10 (254)	12½ (318)	165 (75)
	4x6-10H	A80	4	6				13½ (343)	175 (80)
	1½x3-13	A20	1½	3				10½ (267)	175 (80)
	3x4-13	A40	3	4				12½ (318)	180 (82)
	4x6-13	A80	4	6				13½ (343)	185 (84)

Baseplate Mounting Options

Goulds offers a complete range of mounting systems to meet plant reliability requirements, and to make alignment and maintenance easier.

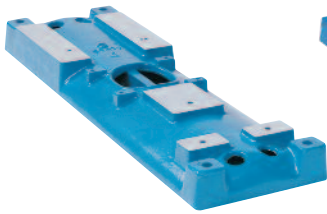

CAMBER TOP CAST IRON
Rigid and corrosion resistant, it is preferred by many plants.

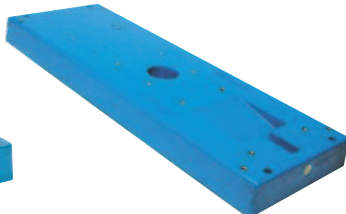

CHEMBASE PLUS™
Polymer concrete construction provides exceptional rigidity and corrosion resistance. ANSI 1991 dimensional.

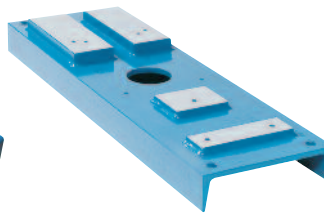

FABRICATED STEEL
Economical baseplate that meets ANSI/ASME B73.1 M current edition dimensional requirements.

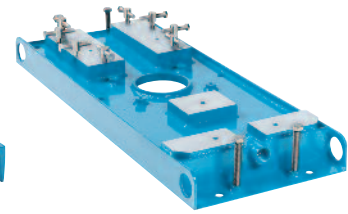

ENHANCED FEATURE FABRICATED STEEL
Upgraded ANSI baseplate designed to maximize pump operation life and ease installation by meeting API-minded chemical pump users toughest requirements.

