



ITT

Goulds Pumps

Goulds IC Series

ISO Chemical Process Pumps
for Worldwide Applications



Engineered for life

motralec

4 rue Lavoisier . ZA Lavoisier . 95223 HERBLAY CEDEX
Tel. : 01.39.97.65.10 / Fax. : 01.39.97.68.48
Demande de prix / e-mail : service-commercial@motralec.com
www.motralec.com

Goulds IC Series

Worldwide Solutions for Process Pumping and Controls

Reducing Pump Life Cycle Costs

Goulds Pumps IC family of ISO chemical process pumps is designed in accordance with ISO 5199 and ISO 2858, making it ideal for worldwide chemical or industrial process applications. The IC pump range includes:

- ◆ 34 hydraulic sizes
- ◆ Flows up to 450 m³/h (1980 GPM)
- ◆ Heads up to 160m (514 Feet)
- ◆ Temperatures from -40°C to 280°C (-40°F to 530°F)
- ◆ Pressures up to 25 Bar (360 PSI)

The IC series represents over 150 years of process pump experience to define a solution which truly reduces your pumping **Life Cycle Cost**. Utilizing a modular design, the IC pump offers broad hydraulic coverage while minimizing the number of pump components for reduced maintenance and inventory cost.

The IC series consists of multiple pump configurations, which have been engineered by ITT hydraulic specialists from Goulds Pumps, to meet both the pumping and environmental needs of customers in the Process Industry. Included in the range is:

- ◆ IC - 16 Bar, mechanically sealed version for most process fluid pumping.
- ◆ ICP - 25 Bar, centerline mounted unit for high pressure applications.
- ◆ ICB - compact, close-coupled design for economical, space-saving service.
- ◆ ICM - magnetic drive, sealless arrangement for the handling of hazardous or sensitive liquids.

ITT Goulds proven pump hydraulic designs utilize precision cast, enclosed impeller for maximum efficiency, low NPSH and reduced hydraulic loads. In addition, all mechanically sealed pumps have been engineered with our patented Cyclone Seal Chamber, a feature proven to provide the optimum sealing environment for extended seal life, critical in reducing Life Cycle Cost.

The IC series is available in a comprehensive range of materials which include ductile iron, 316 Stainless Steel, Duplex Stainless Steel, Alloy 20, Hastelloy B and C, and Titanium.



**Installations
Worldwide**

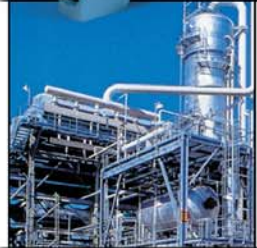

ITT Industrial Process

Global Presence

The IC family of products has a complete world-wide presence.

With manufacturing, engineering, sales and inventory in multiple regions, this product can support your needs everywhere in the world. You can rest assured that we will support your industrial pump requirements, even if you specify and order the pump in one country and need to install it on the other side of the world.



125 Countries | 110+ Distributors/Agents | 2,300 Employees

We will be there for you.



IC and ICM Plant Engineering Product of the Year



Plant Services MRO Product of the Year

IC Pumps installed in a chemical plant in Western Europe on reactor water with mixed chemical stream. ▶



ICM mag-drive pump installed in Western Europe on chemical service. ▶



Goulds Reliability

Long-term Reliable Performance Means Lower Life-Cycle Costs.

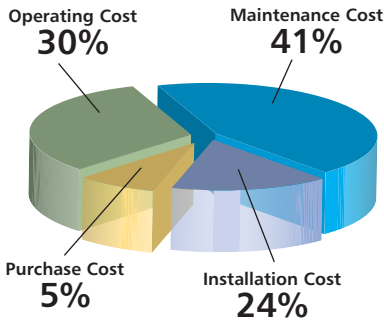

When selecting a chemical process pump, look for the design features that help lower maintenance costs as well as operating and installation costs. Design features that maximize reliability and ensure long-term maintainable hydraulic performance help lower the "total cost" of pump ownership. In a typical process pump, over a 20 year pump life, 95% of the total costs are maintenance, operation and installation costs.

Only 5% is the initial pump cost.

The Keys to Reliable Performance The "Cyclone" Seal Chamber and a Heavy Duty Bearing Frame.

FACT:

The number one cause of pump downtime is failure of the shaft seal. Typically, seal failures are the result of an unfavorable seal environment such as poor heat dissipation, poor lubrication or operation in the presence of solids or vapors.

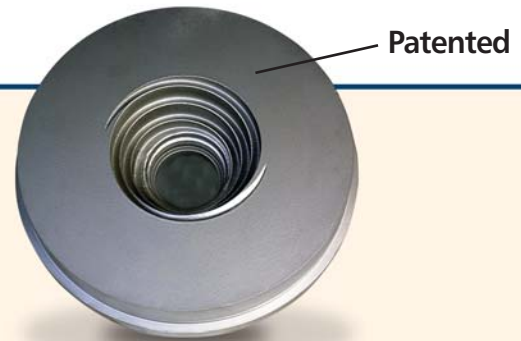

Patented cyclone seal chamber design maximizes seal life.

- A tapered bore design enhanced with a helical groove removes suspended solids away from mechanical seal components resulting in extended seal life.
- Increased radial clearance and volume provides improved cooling for extended seal life.
- Seal venting design eliminates a build-up of vapors in the seal area.
- Patented design has been rigorously tested for reliable results.

Optimized Oil Sump Design

Internal sump geometry is optimized for longer bearing life. Sump size increased by 10% -20% results in better heat transfer and cooler bearings. Contoured design directs contaminants away from bearings, to the magnetic drain plug for safe removal.

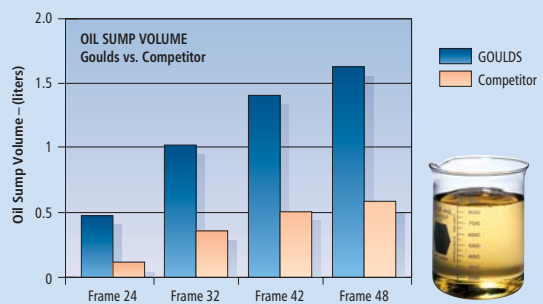
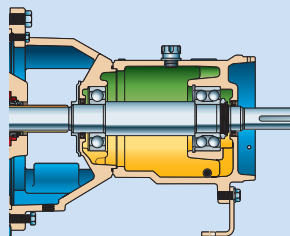

FACT:

The second largest cause of pump downtime is bearing failures. Over 90% of all pump bearing failures are the result of inadequate or contaminated lubrication.

Rigid bearing frame extends pump life.

- Large capacity oil sump results in cooler, cleaner oil. The Model IC ISO chemical pump has the largest oil sump in its class!
- Heavy duty bearing sized for L₁₀ bearing life in excess of 17,500 hours.
- Rigid, stainless steel shaft resists corrosion while maintaining shaft deflections below 0.05mm.
- Double lip oil seals maintain clean oil sump.
- O-ring seal between frame and lantern ensures clean oil environment.

Shaft Sealing Solutions

Engineered to Extend Seal Life and Lower Maintenance Costs

Based on over 150 years of providing pumping solutions to the Chemical Process Industry, ITT Industries can provide a shaft sealing system that best meets your application requirements. Key to our shaft sealing program is placing the best shaft sealing solution in the best operating environment for long life and reduced maintenance and operating costs.



Patented Cyclone Seal Chamber Design

At the heart of our program is the patented cyclone seal chamber that not only provides the optimum seal environment in the presence of solids and vapors, but also improves maintainability and reduces installation cost by eliminating seal flush piping.

Here's how it works:

- 1 Cast helical ribs act as a barrier to particles traveling within the inward boundary layer flow found on the tapered walls of the seal chamber.
- 2 Once caught in the grooves of the helical ribs, the "cyclone-like" rotational velocity created by the impeller carry particles out of the seal chamber away from the seal.

Solids removal is key to prevent seal and seal chamber wear as well as clogging of the mechanical seal for guaranteed reliability.

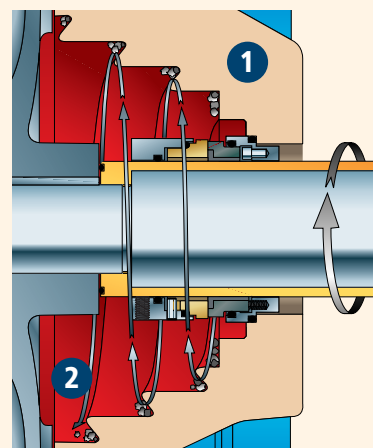

Maximum seal flexibility

Because selecting the best seal for the application is key to extended pump reliability, seal chambers for the Model IC pump have been designed in accordance with ISO 3069 to support the use of a wide range of seals.

The shaft sealing arrangements possible include the use of any DIN 24960L 1K compliant seal arranged in single, single with quench, double (back-to-back) or tandem configurations. Sealing with cartridge type seals is also possible for customers seeking to obtain further reductions in downtime and maintenance costs.

Proprietary mechanical seal

Also available is a propriety mechanical seal engineered for optimum performance when installed in the cyclone seal chambers. Our mechanical seals feature balanced seal faces installed in a stationary spring design that has been integrated with the pump shaft sleeve. This arrangement extends seal reliability and reduces customer costs.

Benefits of our mechanical seal design

- Eliminates shaft sleeve fretting for extended seal life.
- Balanced design reduces face loading.
- Springs are located external to the pumpage which helps reduce seal clogging and corrosion.
- Unitized shaft sleeve and seal simplify installation and reduces spare parts.

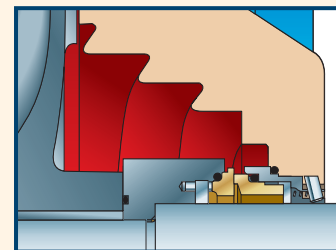

GS11 Single Mechanical Seal

Goulds Engineered Pump Mounting Systems

Proper installation and alignment are two key elements to maximize pump reliability. There are multiple mounting systems for the Model IC series. Simple to install, they provide a mounting platform resistant to corrosion and distortion while maintaining pump alignment and dampening the effect of harmful vibrations.



Standard Baseplate Design

- ◆ Rigid fabricated steel design.
- ◆ Machined pump and motor mounting surfaces make final alignments quick and accurate.
- ◆ Dimensions conform to ISO 3661 for easy installation.
- ◆ Suitable for grouted and ungrouted applications.
- ◆ Optional drip pan with 1" drain connection.
- ◆ Available in stilt mounted arrangement.

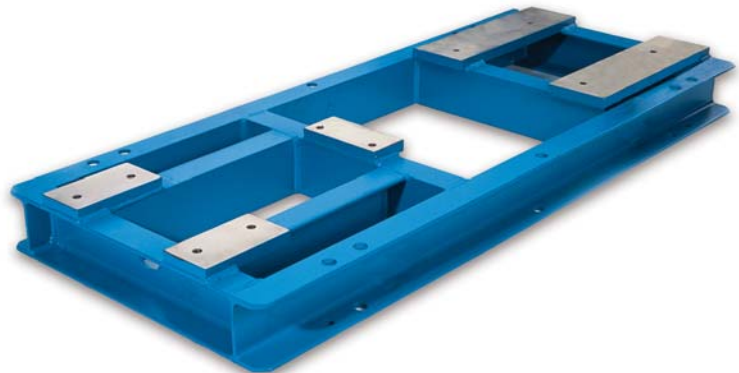

Feature Baseplate Design

- ◆ Structurally reinforced for maximum torsional and axial stiffness.
- ◆ Machined pump and motor mounting surfaces.
- ◆ Complies with ISO 3661.
- ◆ Includes value-added features:
 - Stainless steel drip pan with 1" drain.
 - Motor adjustment screws.
 - Vertical leveling screws.
 - Earthing lug.

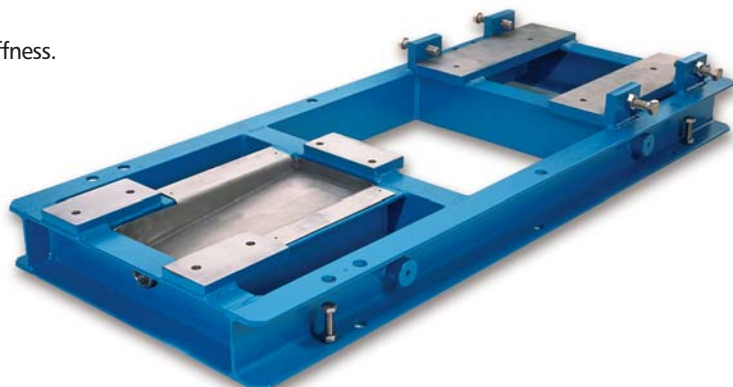

Standard Options Designed for Flexibility to Meet Customer Needs

Suction Inducer

All sizes of the Model IC ISO chemical pump can be supplied with an optional suction inducer which can extend the operating range of the pump by improving the inlet flow into the impeller resulting in reductions of NPSH_r. Inducers provide a more economical pumping solution as smaller, faster pumps can often be used. In addition, inducers can help eliminate cavitation caused by intermittent process conditions and entrained gas or vapor.

Inducer benefits:

- ◆ Reduces NPSH_r by 35-50% – ideal for marginal NPSH applications.
- ◆ Allows for use of smaller, faster pumps – reducing costs.
- ◆ Eliminates pumping problems on services with entrained gas.
- ◆ No compromise to pump operating range.
- ◆ All sizes available in stainless steel and higher constructions.
- ◆ Proven design with over 30 years of application experience.

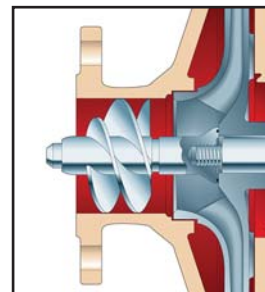

Bearing Frame Options

- 1 Grease Lubrication**
Fitted with grease fitting for regreaseable bearings or sealed for grease for life bearings.
- 2 Constant Level Oiler**
Preset for correct oil level. Oil reservoir decreases maintenance intervals.
- 3 Labyrinth Oil Seal**
Special stainless steel and bronze construction for maximum life and corrosion resistance.
- 4 Provisions for Bearing Monitors**
Tapped connections for thermocouple and vibration sensing monitoring.

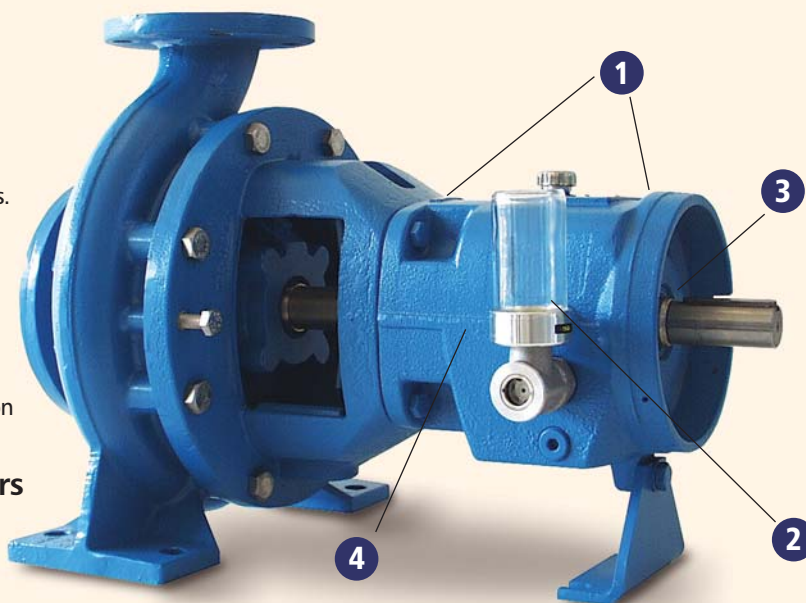

High Temperature Service



Case Wear Rings
Renews pump performance.

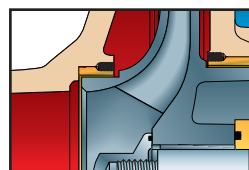

Bearing Frame Finned Cooler
Directly cools oil for lower bearing operating temperature. Requires minimal cooling water. Corrosion resistant construction. Recommended for temperatures over 180°C when using conventional oil, over 230°C when synthetic oil is used.

Jacketed Casing and Seal Chamber
For heating and cooling of product.

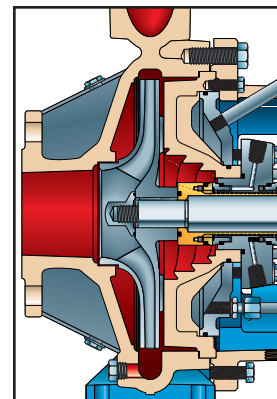

IC Series Hydraulic Coverage 50Hz Performance

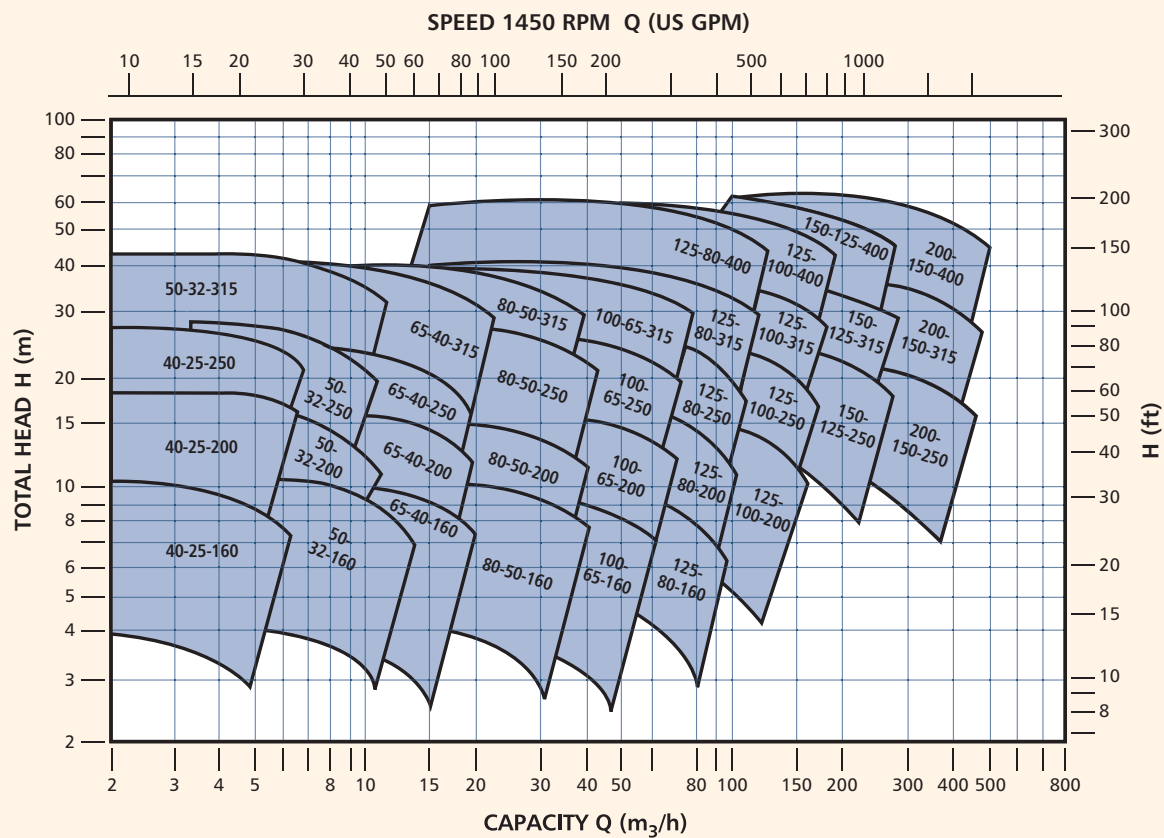
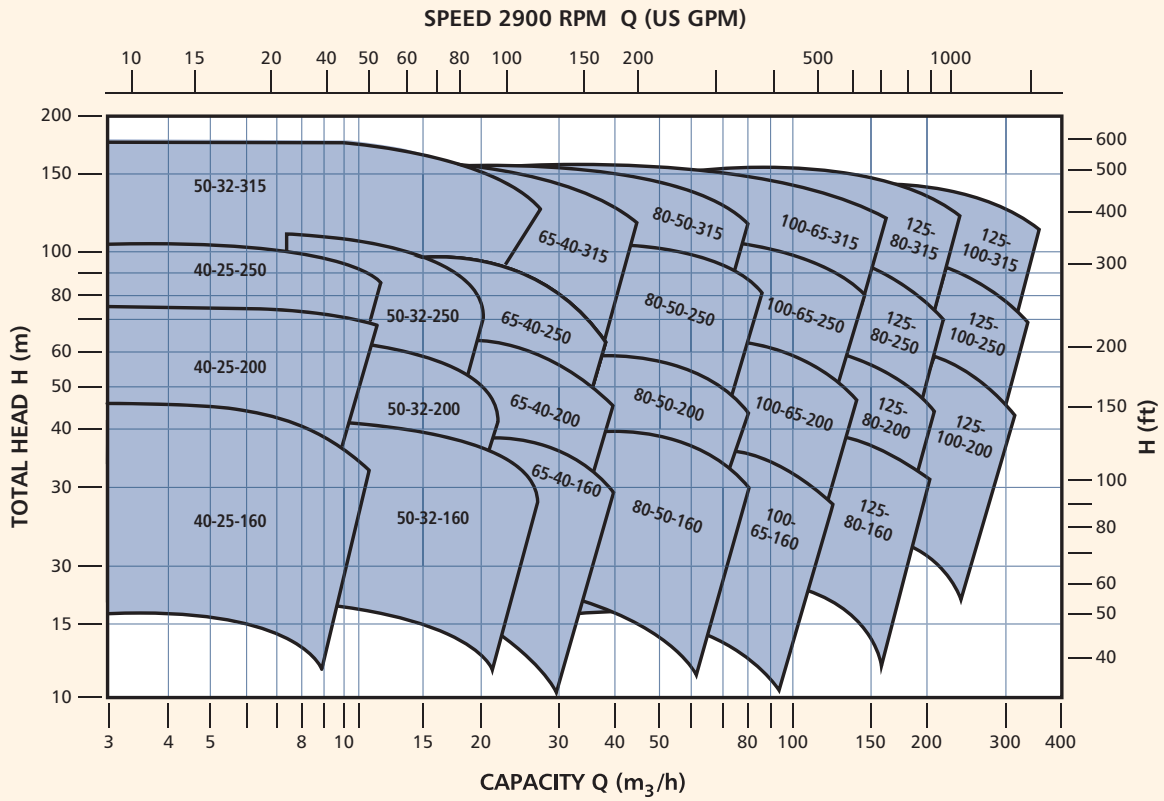

IC Series Hydraulic Coverage 60Hz Performance

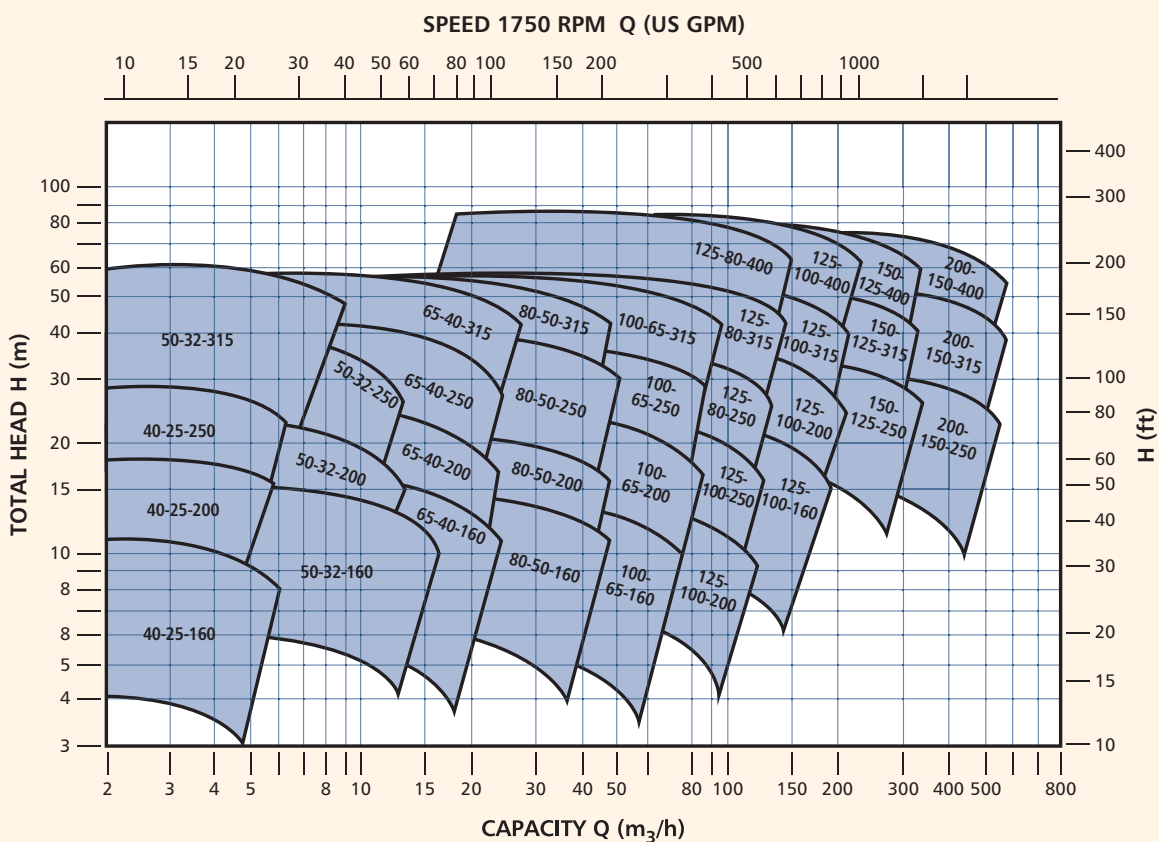
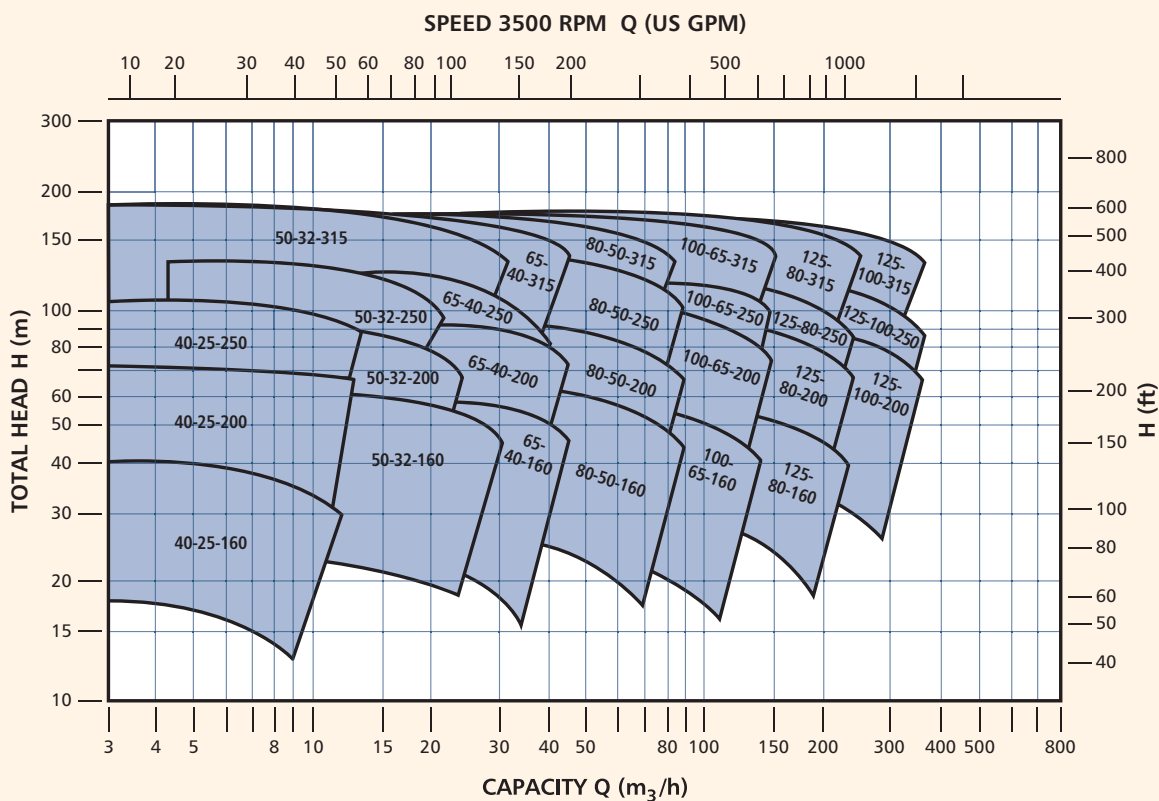



IC Series Chemical Process Pumps

Standard features that provide process reliability

BEARING FRAME

- Large capacity oil sump reduces oil temperature for extended bearing life.
- Heavy duty cast iron frame gives rigid support to shaft and bearings for longer service.
- Magnetic drain plug maintains a clean oil environment for extended bearing life.
- Standard double lip seals at pump and coupling end maintain a seal tight, clean operating environment.
- O-ring seal between frame and adapter for optimized alignment and sealing.

HEAVY DUTY SHAFT AND BEARINGS

- Rigid shaft designed for less than 0.05mm shaft deflection.
- Heavy duty ball bearings engineered to provide L10 bearing life in excess of 17,500 hours.
- Standard 400 series stainless steel shaft (1.4021) provides reliable power transmission and corrosion resistance at both the pump and coupling ends.

DUCTILE IRON LANTERN/ FRAME ADAPTER

- Provides safe and accurate alignment for the liquid end to the bearing frame.
- Large access windows make installation and maintenance of seal and auxiliary support systems trouble-free.

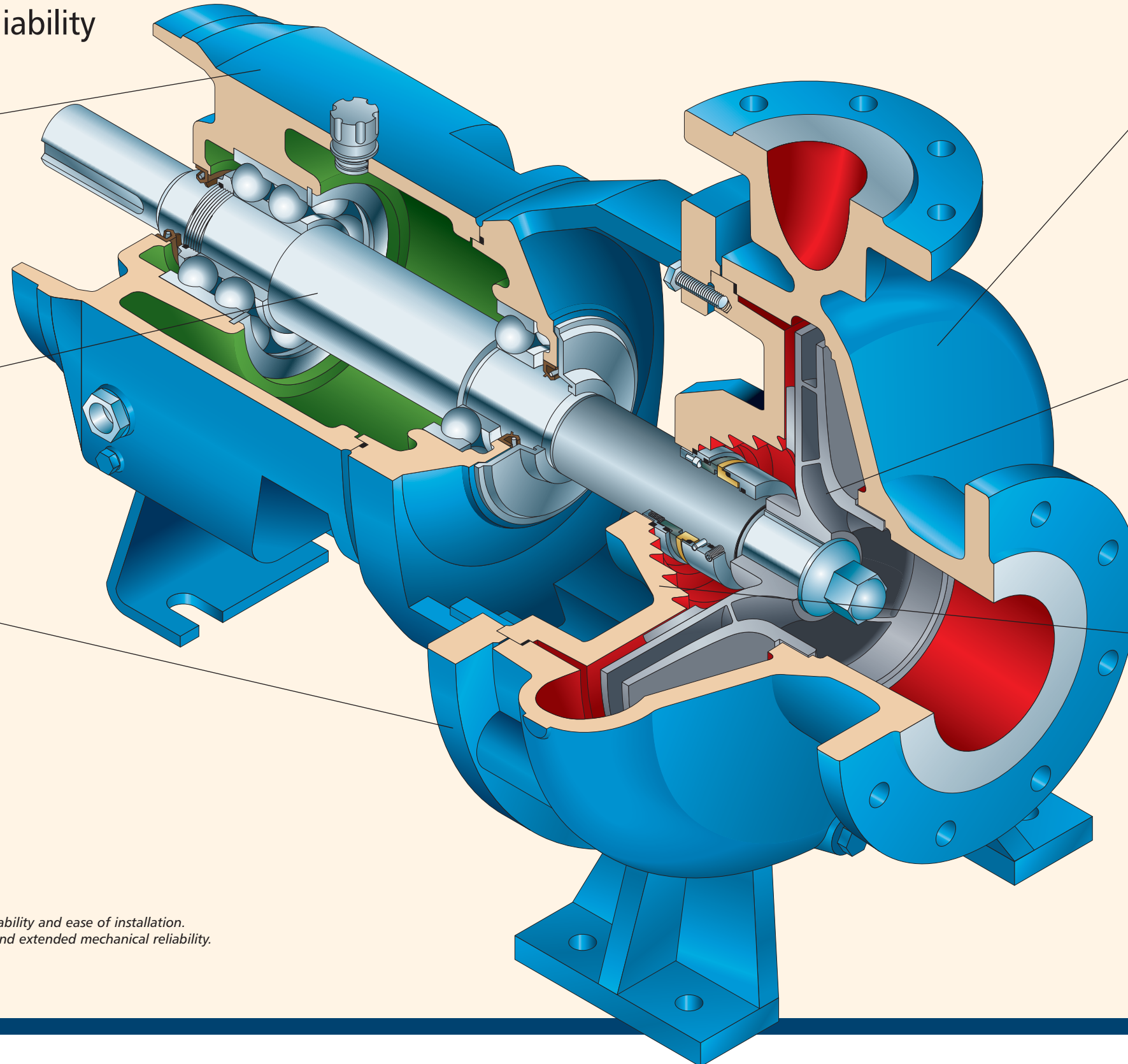

CASING

- Heavy duty, top centerline discharge casing with integral cast feet provides maximum resistance to pipe loads for improved seal and bearing life.
- Minimum 3mm corrosion allowance maximizes pump life for corrosive and erosive applications.
- Back pull out design makes maintenance activities safe and simple.
- Standard 3/8" NPT casing drain for safe maintenance.
- Renewable wear ring maintains pump performance over the life of the pump (optional).

IMPELLER

- Precision-cast enclosed impeller design provides maximum efficiency and optimum NPSH performance.
- Preferred by ISO 5199 for maximum mechanical seal life.
- Standard back vanes or balance holes reduce axial thrust and seal chamber pressures for extended bearing and seal life.
- Key driven for maximum reliability eliminates spin-offs due to reverse rotation during start-up.

ENGINEERED SHAFT SEALING ENVIRONMENT

- Wide choice of sealing arrangements for maximum sealing flexibility.
- Patented "cyclone" seal chamber improves lubrication, heat removal and solids handling for ultimate seal life.
- Confined casing gasket provides safe pressure containment against gasket "blow out" and protects alignment fits from corrosion for ease of maintenance.

Conforms to ISO 5199 and ISO 2858 for maximum reliability and ease of installation.
Superior hydraulic design for maximum performance and extended mechanical reliability.

Dimensions IC SERIES

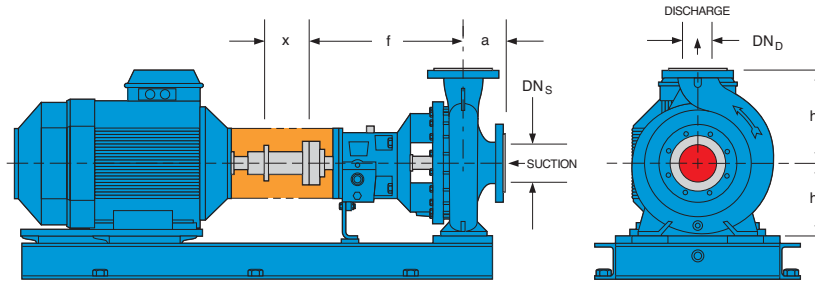

DIMENSIONS									
Pump Size	Frame	Flanges		a	f	h1	h2	X	Bare Pump weights
		DNs	DNd						
40-25-160	24	40	25	80	385	132	160	100	42
40-25-200	24	40	25	80	385	160	180	100	50
40-25-250	32	40	25	175	500	180	225	100	79
50-32-160	24	50	32	80	385	132	160	100	43
50-32-200	24	50	32	80	385	160	180	100	52
50-32-250	32	50	32	100	500	180	225	100	85
50-32-315	32	50	32	210	500	200	250	100	111
65-40-160	24	65	40	80	385	132	160	100	44
65-40-200	24	65	40	100	385	160	180	100	57
65-40-250	32	65	40	100	500	180	225	100	85
65-40-315	32	65(1)	40(1)	125	500	200	250	100	121
80-50-160	24	80	50	100	385	160	180	100	48
80-50-200	24	80	50	100	385	200	100	100	57
80-50-250	32	80	50	125	500	180	225	100	87
80-50-315	32	80(1)	50(1)	125	500	225	280	100	126
100-65-160	32	100	65	100	500	160	200	100	74
100-65-200	32	100	65	100	500	180	200	140	79
100-65-250	32	100	65	125	500	200	250	140	98
100-65-315	42	100(1)	65(1)	125	530	225	280	140	150
125-80-160	32	125	80	125	500	180	225	140	81
125-80-200	32	125	80	125	500	180	250	140	87
125-80-250	32	125	80	125	500	225	280	140	109
125-80-315	42	125(1)	80(1)	125	530	250	315	140	162
125-80-400	42	125	80	140	530	280	355	140	201
125-100-200	32	125	80	125	500	200	280	140	93
125-100-250	42	125	100	140	530	225	280	140	130
125-100-315	42	125(1)	100(1)	140	530	250	315	140	174
125-100-400	42	125	100	140	530	280	355	140	215
150-125-250	42	150	125	140	530	250	355	140	143
150-125-315	42	150	125	140	530	280	355	140	195
150-125-400	42	150	125	140	530	315	400	140	246
200-150-250	42	200	150	160	530	280	375	180	152
200-150-315	48	200	150	160	670	315	400	180	262
200-150-400	48	200	150	160	670	315	450	180	303

Dimensions in mm
Dimensions subject to change
without notice

Note: Flange drilling in accordance
with ISO 7001/EN 27001 PN16
except where noted

(1)-Flanges drilled PN25

Detailed pump dimensions in
accordance with ISO 2858/EN22858
Detailed baseplate dimensions in
accordance with ISO 3661/EN23661

MATERIAL SPECIFICATIONS			
Casted Material Standards			
	Approximate Equivalent Standards		
	IC Series Standard	DIN	ASTM
Cast Iron	EN-GJL-250	0.6025	A48, Class 35B
Ductile Iron	EN-GJS-400-18-LT	0.7043	A536, grade 60-40-18
Stainless Steel	1.4408	1.4408	A743, CF-8M
Duplex SS	1.4517	1.4517	A744 CD4-MCu
Alloy 20	1.4536	1.4536	A743 CN-7M
Hastelloy C	V2.4811	2.4811	A494 N-12MV
Hastelloy B	V2.4810	2.4810	A494CX 2MV
Titanium	3.7031	3.7031	B367 Grade 2

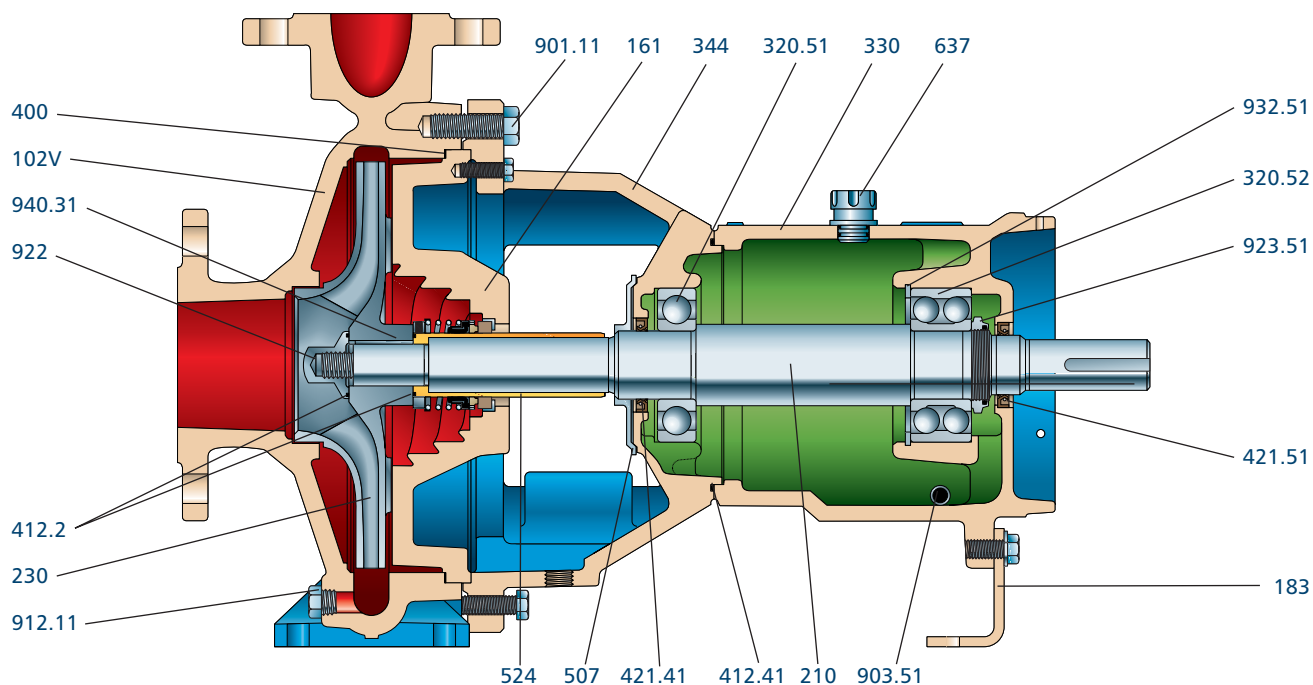

Parts List and Materials of Construction

Item Number	Part Name	MATERIAL					
		DI/316SS (VL)	316SS (VV)	Duplex (WW)	Alloy 20 (AA)	Hastelloy (BB/CC)	Titanium (TT)
102V	Casing	DI/316SS	316SS	Duplex SS	Alloy 20	Hastelloy	Titanium
161	Seal Chamber/Stuffing Box Cover	DI/316SS	316SS	Duplex SS	Alloy 20	Hastelloy	Titanium
183	Support Foot	Carbon Steel					
210	Shaft	Stainless Steel (1.4021)					
230	Impeller	316SS		Duplex SS	Alloy 20	Hastelloy	Titanium
320.51	Radial Bearing	Single Row, Ball Bearing					
320.52	Thrust Bearing	Double Row Angular Contact Ball Bearing					
330	Bearing Bracket	Cast Iron					
344	Lantern	Ductile Iron					
400	Case Gasket	Non-Asbestos Aramid Fiber					
412.21	O-ring, Shaft Sleeve & Impeller Nut	Teflon					
412.41	O-ring Bearing Bracket	Buna					
421.41	Oil Seal, Inboard	Lip Seal (Buna & Steel)					
421.51	Oil Seal, Outboard	Lip Seal (Buna & Steel)					
507	Flinger	Noryl 66					
524	Shaft Sleeve	316L (1.4404)		Duplex SS	Alloy 20	Hastelloy	Titanium
637	Oil Vent	Steel					
901.11	Casing Bolts, Hex Cap Screw	Stainless Steel (A2)					
903.51	Drain Plug	Steel Magnetic Tipped					
912.11	Case Drain Plug	316SS		Alloy 20		Hastelloy	Titanium
922	Impeller Nut	Duplex SS		Alloy 20		Hastelloy	Titanium
923.51	Bearing Lock Nut	Steel/Nylon					
932.51	Snap Ring/Circlip	Carbon Steel					
940.31	Impeller Key	Carbon Steel					

Other Parts Not Shown							
236	Inducer (optional)	Duplex SS (1,4462)			Alloy 20	Hastelloy	Titanium
452	Packing Gland	316ss					
458	Lantern Ring	Glass Filled PTFE					
461	Packing	PTFE Impregnated					
502.11	Wear Ring (optional)	316ss (1.4410)		DuplexSS	Alloy 20	Hastelloy	Titanium
642	Oil Level Sight Glass	Glass/Plastic					

Goulds ICM Series

Magnetic Drive, Sealless... Leak Proof

The ICM metallic magnetic drive process pump safely and reliably handles difficult fluids such as corrosives, toxic, and ultra pure liquids. Complies with ISO 2858, 5199, and 15783.

Specifications

- ◆ Capacities to 340 m³/h (1490 USgpm) at 2900 rpm & 400 m³/h (1760 USgpm) at 3500 rpm
- ◆ Heads to 160 m (525 feet) at 2900 rpm & 210 m (685 feet) at 3500 rpm
- ◆ Temperature Range -40° C to 180° C (-40°F to 360°F), optional as ICMP up to 280°C (530°F)
- ◆ Pressures to 16 Bar (235 PSIG), optional 25 Bar (360 psi); sizes 65-40-315 nd 80-50-315: 25 Bar (360 psi) standard
- ◆ Materials - Stainless Steel (1.4408), Duplex Stainless Steel (1.4517), Alloy 20 (1.4536), Hastelloy C (2.4811), Titanium (3.7031)

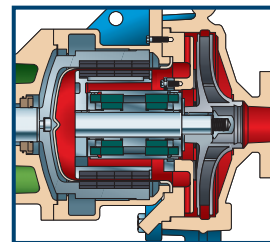

Reliable, Simple – Easy To Maintain

Maintenance Made Simple

The ICM was designed with the end user in mind. Fewer parts make planned maintenance faster and easier than other sealless and sealed process pumps. The S group is also available in a close coupled configuration, further eliminating the need for time-consuming pump and motor alignment.



Leadership in Sealless Pump Technology

Design Features for Extended Pump Life

Bearing Cartridge

Individual bearings are contained in a single cartridge assembly.

- ◆ Bearings are made of highly abrasion and corrosion resistant silicon carbide. Dryguard™ bearings are available for protection against occasional dry run conditions.
- ◆ In the event of bearing failure, the cartridge design contains the bearings and prevents further damage to pump internals.
- ◆ Installation and replacement of bearings is simple. Only one component to install.



Containment Shell

The containment shell is the most important component isolating the pumpage from the atmosphere.

- ◆ The containment shell is a deep-drawn single piece design made from Hastelloy C for reliable corrosion resistance.
- ◆ The vortex-breaking bead at the bottom of the can prevents erosion.
- ◆ Burst pressure is greater than 150 bar.



Dryguard™ Bearings

The heat generation from dry run conditions is the number one mode of failure for sealless pumps. Dryguard™ is a diamond-like carbon that reduces the coefficient of friction by over 70% enabling short periods of safe operation under dry run conditions. Dryguard™ is up to 2X harder than silicon carbide, ensuring its benefits cannot be compromised in even the harshest conditions.



High Temperature Applications

The High Temperature option is perfect for applications between 180°C and 280°C. This option includes Samarium Cobalt magnets and a special High Temperature bearing cartridge designed to handle the additional rate of thermal expansion.



Goolds ICM-B Series

Close-Coupled Economical Design

Specifications

- ◆ Block Pump design available on all Frame 24 sizes.
- ◆ Adapters available for IEC and NEMA Motor Frames.
- ◆ Eliminates coupling and alignment concerns.

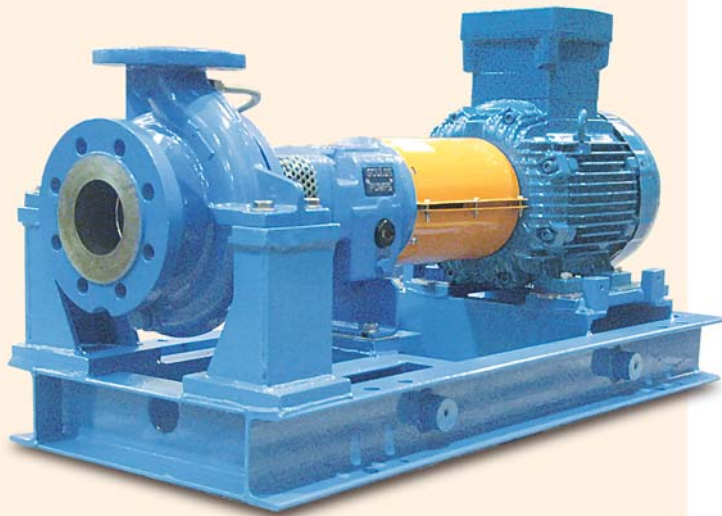

Goulds ICP Series

High Pressure and High Temperature

The ICP is a heavy duty chemical process pump designed for extreme temperatures (-40°C to 280°C) and pressures to 25 Bar. Centerline mounted casing controls thermal growth and maintains pump alignment for extended seal life. Complies with ISO 5199.

Specifications

- ◆ Capacities to 450 m³/h (1980 USgpm)
- ◆ Heads to 150 m (492 feet)
- ◆ Temperature Range -40°C to 280°C (-40°F to 535°F)
- ◆ Pressures to 25 Bar (363 PSIG)
- ◆ Materials - Carbon Steel (1.0619), Stainless Steel (1.4408), Duplex Stainless Steel (1.4517), Hastelloy C (2.4811)

Goulds ICB Series

Close-coupled, Economical Installation

The ICB close-coupled chemical process pump provides an economical, space-saving design, which simplifies installation and reduces costs. Precise alignment eliminates the multiple craft installation costs.

No baseplate. No flexible coupling. Floor space utilisation is maximized. Complies with ISO 2858. Available on all frame 24, 32 and 42 pump sizes.

Specifications

- ◆ Capacities to 340 m³/h (1490 USgpm)
- ◆ Heads to 160 m (525 feet)
- ◆ Temperature Range -40°C to 140°C (-40°F to 280°F)
- ◆ Pressures to 16 Bar (235 PSIG)
- ◆ Materials - Ductile Iron (0.7043), Stainless Steel (1.4408), Duplex Stainless Steel (1.4517)





PRO Services®
Extending
Equipment Life...

Product Repair

- Service Center Repair
- Turnkey Repair/ Installation
- Field Service
- Emergency Service

Reliability Improvement

- Predictive Condition Monitoring
- Root Cause Failure Analysis
- Machine & System Assessment
- Engineered Upgrades
- Training

Optimization of Assets

- Inventory Management
- Replacement/Exchange
- Maintenance Management
- Contract Maintenance

-
- | | |
|-------------------------------------|---|
| • All Brands | • Fast Turnaround |
| • Factory Trained Service Personnel | • Emergency Service – 24 hours/day, 7 days/week |
| • Quality | • ISO and Safety Certified |

PROSMART

ProSmart® provides continuous machinery monitoring to identify little problems before they become big problems...like downtime. Using wireless technology, advanced signal processing capabilities, and easy-to-deploy sensors, ProSmart offers an affordable means to monitor all of your rotating equipment anywhere in the world.



By identifying and alerting you to changes in operating conditions, ProSmart increases your time to respond to either correcting the upset condition, or properly plan its repair.

Key Features include:

- **Continuous data acquisition and analysis** – ProSmart collects vibration, temperature, and available process conditions every five seconds; saving you time from routine data collection.
- **Automatic notification and accessibility** – By alerting when a machine goes into distress, you are able to focus your resources on recovery activities. The ProNet web-hosted solution allows access to information anywhere in the world through a standard Internet browser connection.
- **Advanced diagnostic tools** – More than simple overall data, ProSmart provides advanced analysis capabilities such as time-waveform, spectral, and spectral windowing.
- **Easy to deploy** – Using plug and play sensors, wireless connectivity, and an industrially hardened enclosure, ProSmart can be easily deployed throughout your plant, including hazardous areas.

PUMPSMART

PumpSmart® is the latest advancement in pump control and protection to reduce energy consumption, increase uptime and decrease maintenance cost. It allows the pump to be right-sized to the application by dialing in the speed and torque which increases flow economy, reduces heat and vibration, and improves overall system reliability.

- **Simplified Pump Control** — PumpSmart was designed specifically to optimize pumping applications and can be used to control a single pump or coordinate between multiple pumps without the need for an external controller.
- **Pump Protection** — PumpSmart guarantees to protect the pump from upset conditions with patented sensorless pump protection algorithms.
- **Smart Flow** — PumpSmart features a sensorless flow function for centrifugal pumps that can calculate the flow of the pump within ± 5% of the pump rated flow.
- **Drive for the DCS** — While most VFDs can only provide basic information, PumpSmart offers unparalleled insight to the pump operation which allows for smoother process control and efficiency.
- **Pump Experts** — PumpSmart is a variable speed drive with pump-specific algorithms imbedded into the drive. With over 150 years of pump knowledge, let the pump experts take responsibility of your pump system.



Pick Your Perfect Process Pump

We offer the broadest range of process pumps available on the market. Pumps for severe corrosives, abrasives or contaminated media, for high temperatures or hazardous liquids, for media with fibrous solids, for low or high flow rates. No matter what your need, we'll find you the optimum, reliable solution.

i-FRAME™ ANSI PROCESS		AXIAL FLOW		HORIZONTAL SPL	
		SUBMERSIBLE			
				MAGNETIC DRIVE	
VERTICAL SUMP		MONITORING AND CONTROL			
		SLURRY			
				MEDIUM CONSID	



Engineered for life

ITCASE



API PROCESS



MULTI STAGE



ISO PROCESS



LARGE END SUCTION

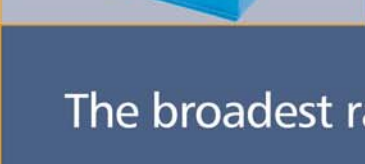

VERTICAL TURBINE



TENCY



The broadest range of process pumps available.

