

GRUNDFOS WASTEWATER PRODUCTS

Grundfos supplies premium wastewater products for all relevant applications in the commercial buildings sector.

Our product range includes:

- Dedicated controls that allow you to monitor your sewage pumping stations wherever you are
- Wastewater pumps suitable for your every need
- Lifting stations for heavy duty pumping from below sewer level
- Pre-fabricated high-tech pumping stations for safe collection and removal of wastewater

GRUNDFOS WASTEWATER PRODUCTS RELIABLE EFFICIENCY FOR ALL APPLICATIONS

COMPREHENSIVE WASTEWATER EXPERTISE

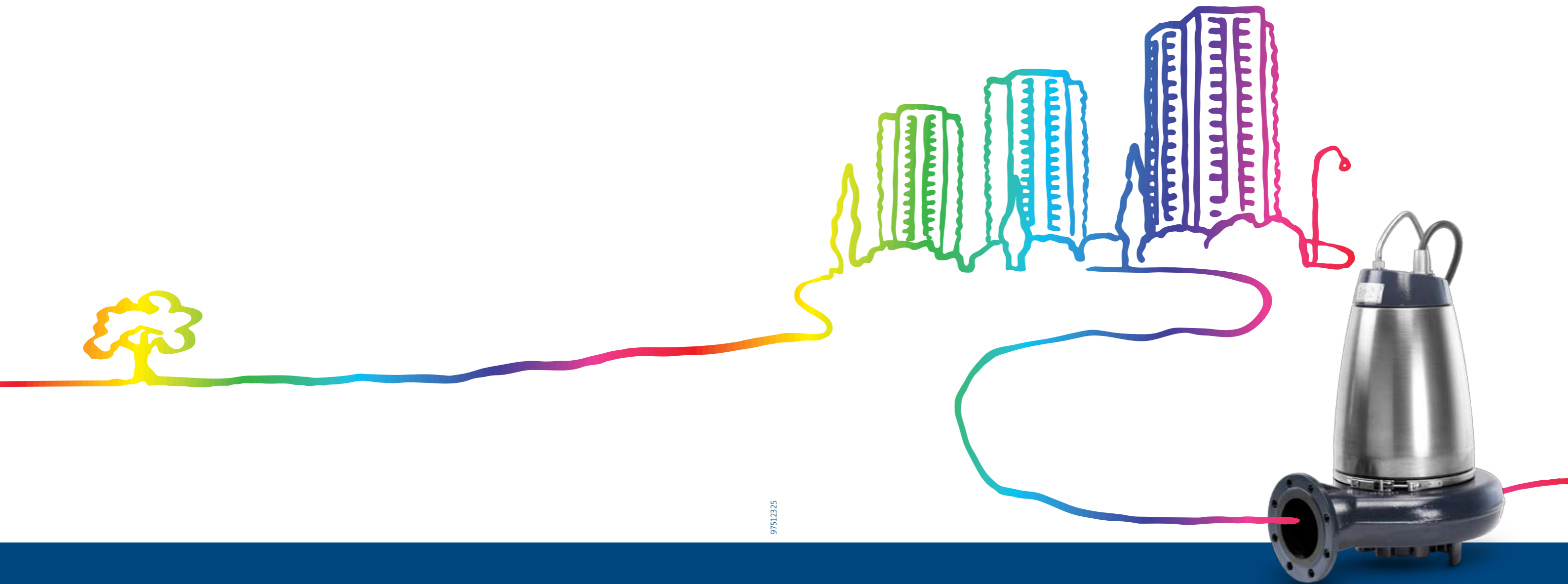

97512325

WASTEWATER PRODUCTS INTRODUCTION

GRUNDFOS IS YOUR DEDICATED SUPPLIER OF FIRST-CLASS WASTEWATER PRODUCTS FOR ANY APPLICATION AREA IN THE COMMERCIAL BUILDINGS SECTOR

If you are looking for a strong and experienced full line supplier of wastewater products, look no further. Grundfos' trademark is to develop and produce high-quality, energy efficient pumps for every area of the commercial buildings sector, and wastewater is no exception. Increasing urbanisation along with the demand for uncompromised comfort makes wastewater a key area to focus on for every professionally engaged planner, and Grundfos is there to help throughout the process. We offer pumps, lifting stations and pumping stations for:

- Drainage water (including groundwater)
- Rain and surface water
- Grey water
- Black water

ALL APPLICATIONS – ONE EXPERT

When we call ourselves wastewater experts, it is not something we do lightly. The wastewater area is complex and our renowned wastewater technology builds on decades of experience, innovation, scientific trials and testing. Our dedication is the foundation on which we have built the product range we offer today, which includes a full scope of products within these four areas: drainage water, surface water, grey water and black water.

- Drainage water is mainly groundwater, rain and surface water with solids up to 12 mm.
- Surface water is rainwater containing sand, stones, leaves and other dirt with solids up to 50 mm.
- Grey water is dirty water from, for example, laundry rooms and basements with fibres and solids up to 35 mm.
- Black water is untreated wastewater and raw sewage water with faecal matter, fibres, textiles and other large solids up to 100 mm.



The Grundfos wastewater product range includes pumps for all applications includes pumps and lifting stations for all applications

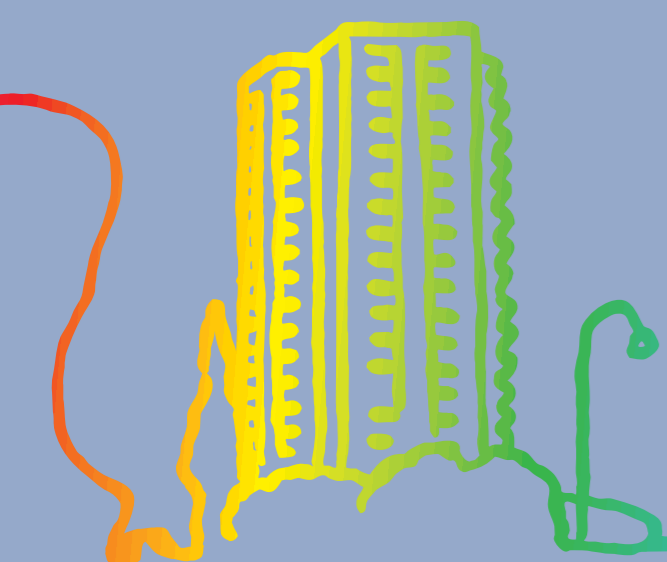

WASTEWATER PRODUCTS

ALL APPLICATIONS COVERED



Königsbau Passage, Stuttgart

The Königsbau Passage is Stuttgart's main shopping mall with 27,000m² retail space and 18,000m² office space. This calls for flexible solutions throughout, as tenants, office workers and shoppers come and go. To achieve the ambitious energy-efficiency targets set for this project, Grundfos was brought in as the pump solution supplier. Our wastewater solution in this case consists of variable-speed pumps that ensure high energy-efficiency and MDV series lifting stations with up to three 400 litre tanks, which together provide the flexibility needed in a building of this type.

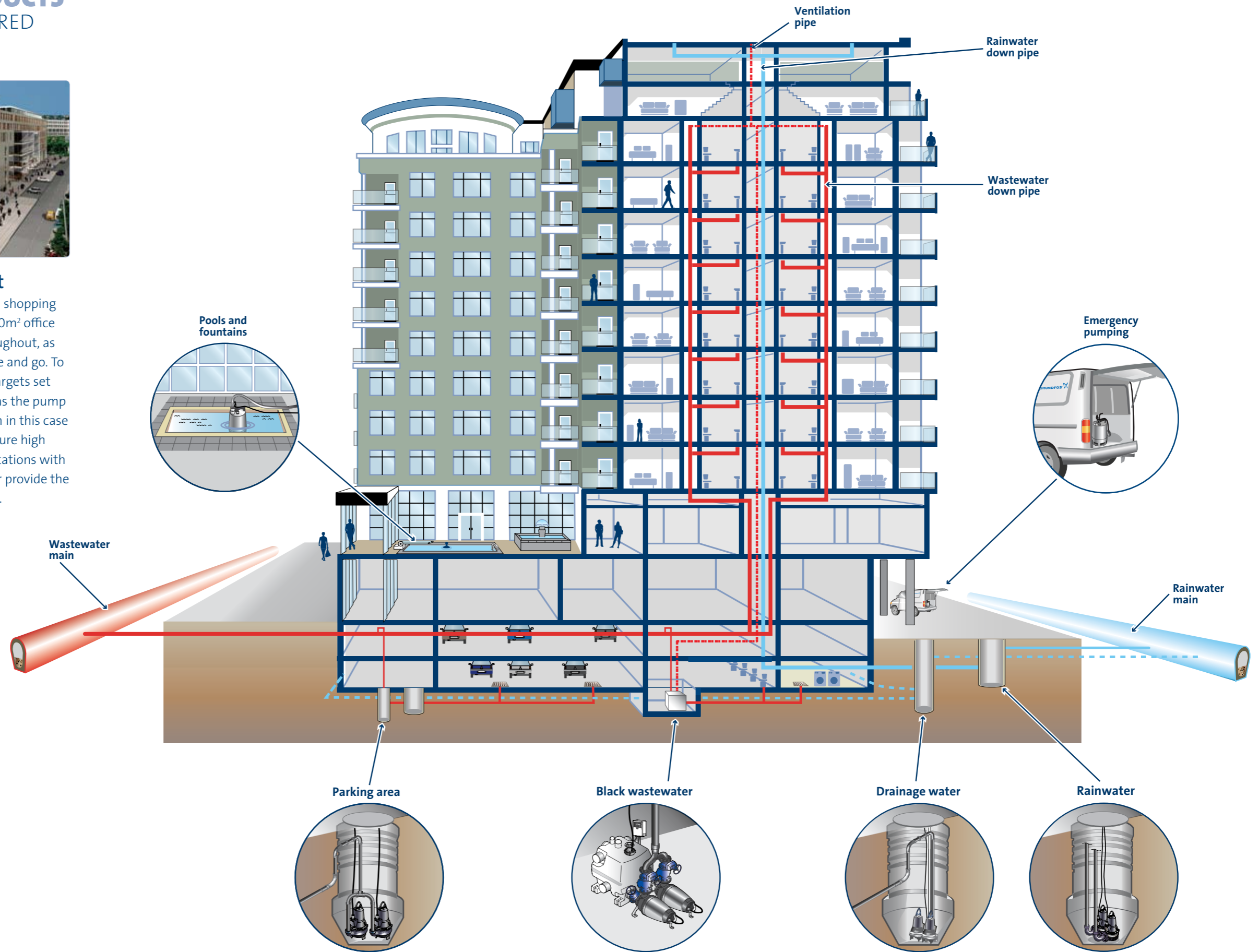

WASTEWATER PRODUCTS OVERVIEW

COMPLEX PRODUCTS – EASY SELECTION

Our products are specialised pieces of technology, each one constructed to meet its unique set of demands. However, they share the intelligent design, high quality materials and high efficiency common to all Grundfos solutions. For an initial overview of our product range, look at the chart below. The products are divided into three groups: pumps, lifting stations and pumping stations. An in-depth description of each product is covered in the following pages.

Which application area for which product type?

* It is not recommended to use a PUST station with a grinder for drainage or surface water.

Type of wastewater	Pumps			Lifting Stations		Pumping Stations
	Unilift	DP/EP	SE1, SEV, SEG	Uno/Duolift	Multilift Series	PUST
Drainage water	✓	✓	✓			✓ *
Grey water	✓	✓	✓	✓	✓	✓
Black water			✓	✓	✓	✓
Surface water	✓	✓	✓			✓ *

* It is not recommended to use a PUST station with a grinder for drainage or surface water.

TAKE CONTROL EVERYWHERE

Wastewater technology is not all about pumps. A wastewater solution performs at its best when it is combined with the ever-vigilant supervision of a Grundfos “Dedicated Controls” system.

Dedicated Controls monitor and control sewage pumping stations and allow commercial buildings to integrate sewage handling into their building management system.

The Dedicated Controls’ wireless connection enables you to keep track of your building’s pumping systems wherever you are, which means you’re never caught off guard. Furthermore, the Dedicated Controls feature the following benefits:

- Full data logs
- Early warning system
- Connect to all standard PLCs, SCADA and BMS systems
- Compatible with Grundfos Remote Management GRM
- Text messaging feature allows you to control pumps and receive information via text messages
- Severely reduces time spent on reporting, collecting data and service visits
- Emergencies are reduced to a bare minimum



The Dedicated Controls system features a large, user-friendly display and unique wireless and wired connections.

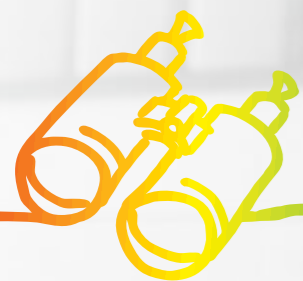

WASTEWATER PRODUCTS PUMPS

PUMPS THAT GET THE JOB DONE

SEV and SE1 – 90% of your pumping needs covered

We are pleased to introduce you to the SEV and SE1 pumps – our most versatile wastewater range. The SEV and SE1 pumps offer motor sizes from 1.1 to 11 kW and thus handle any small, medium or extra large wastewater task. The two pump types share the following features and benefits:

- Watertight and removable cable entry point ensures that no water enters the motor
- Enhanced shaft seal solution with heavy duty ball bearings: a shortened rotor shaft means that vibrations in the pump are reduced providing maximum reliability
- Unique, patented heat transfer solution in all SEV and SE1 pumps and SE1 pumps eliminates the need for cooling liquid and reduces the risk of overheating. Even when the motor is not submerged, you are guaranteed reliable operation. The heat transfer solution also means complete flexibility when it comes to installation.
- Clamp technology for easy access to motor and hydraulics
- Handle solids of up to 100 mm when fitted with particular hydraulics
- Mechanical cartridge shaft sealing means extended lifetime and easy service



The SEV pump with its stainless steel motor jacket

SUPER VORTEX OR SINGLE CHANNEL IMPELLER

The difference between the SEV and the SE1 pump is in the impeller. The SEV comes with a patented super vortex free-flow impeller that makes this pump virtually immune to clogging or jamming. The secret is in the flow inside the pump, which does not pass through the impeller itself, but is guided around it. The SE1 comes with a single-channel impeller that maximises its efficiency and protects against clogging.



Pump performance

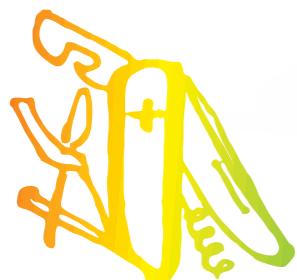
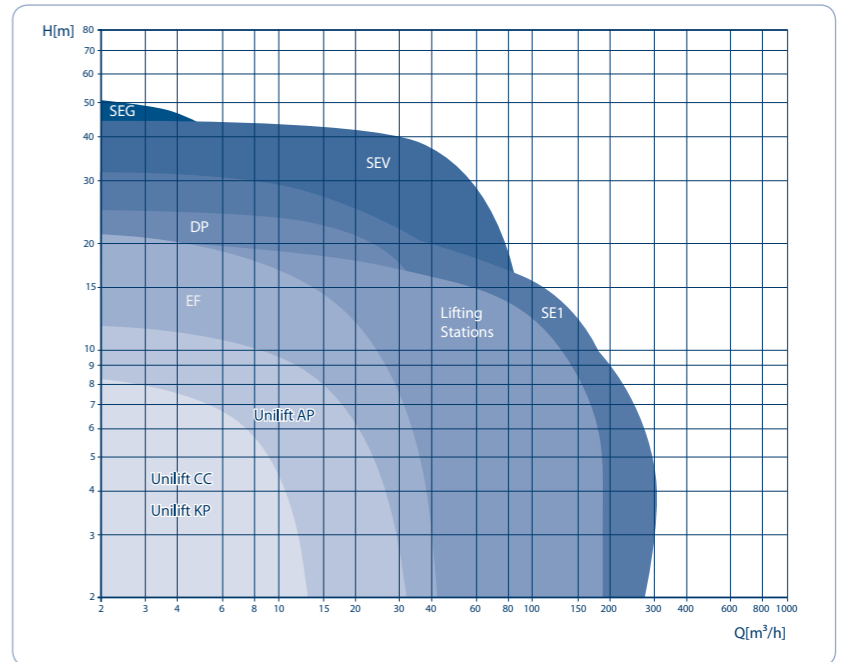

WASTEWATER PRODUCTS PUMPS

FLAWLESS PUMPING RELIABILITY



DP: Heavy duty reliability

The DP is a heavy duty, reliable drainage pump for drainage water, surface water, groundwater and processed water with small solids or fibres. It can be permanently installed in pits with guide rails and auto couplings, or it can be kept on stand-by for immediate flood relief.

SEG: The great grinder

The Grundfos grinder system is a powerful ally. Its high-head pumping abilities and its capability to cut up sewage solids extremely efficiently make it the right choice for pressurised systems or applications where high head and relatively low flow is required. We also recommend the SEG for installations where only small pressure pipes can be used (>DN32) and where the distance to the sewer is great. Grundfos pumping stations (PUST) and lifting stations are pre-fabricated for this type of pump to make installation as effortless as possible.



The KP range of portable pumps next to the larger AP pumps

KP and AP: Portable perfection

Our portable wastewater pumps offer maximum flexibility in usage. Needless to say, we designed them to be transported easily from A to B, but they all work excellently as permanent installations as well.

The KP is a lightweight pump designed specifically for drainage jobs. Its stainless steel surface makes it robust, durable and corrosion free, which reduces maintenance to an absolute minimum. More than one million KP pumps are installed worldwide and prove their reliability every day.

The AP pumps are the KP range's larger cousins. They share many of the same benefits, but the AP pumps are designed for more demanding wastewater tasks, like groundwater lowering and black water work. The AP range is renowned for its reliable performance and low maintenance level.



EF: Fibres? No problem

The EF is the pump you are looking for if your need is excellent handling of solids. This pump features an open single-vane impeller that effortlessly handles solids and fibres from a variety of building service and industrial applications.



WASTEWATER PRODUCTS LIFTING STATIONS

MD1/MDV: TOP OF THE RANGE TOUGHNESS

When size is of the essence and you need a product that can effortlessly reach a total tank volume of 1350 litres, look no further than the MD1 or MDV lifting stations. These wastewater giants come with the superior technology of the SE pumps and provide you with world-class reliability and virtually unlimited operation.

- Well-suited for retrofitting and for new buildings where fast and easy installation is desired
- Easy access and no need for heavy lifting devices during installation, service, maintenance and replacement
- Gas and odour proof
- Low noise operation
- Choose between Super Vortex impeller or channel impeller technology
- Suitable for the most ambitious applications like hospitals, schools and shopping malls

- Plug-and-go installation with flexible connection options, electronic controls and non-return valves included in the package
- Able to operate under flooded conditions
- Microprocessor controller with alternating pump operation and automatic switch-over in case of pump cut out
- Trouble-free operation that requires a minimum of maintenance due to the products' hard-wearing, non-corroding materials
- Come with one tank as standard, but can easily be connected to up to three tanks



MD/MLD: PLUG-AND-GO RELIABILITY

The Grundfos Multilift range is a group of compact, low maintenance, easy to install products that live up to the highest standards and handle the toughest of jobs. They combine pumps, tanks and controls and guarantee reliable operation at the lowest possible cost. The MD and MLD lifting stations are different in size, but share the following exclusive features:

- Handle any kind of wastewater
- Well-suited for retrofitting and for new buildings where fast and easy installation is desired
- Easy access and no need for heavy lifting devices during installation, service, maintenance and replacement
- Gas and odour proof
- Low noise operation
- Super Vortex no-clogging-guaranteed impeller
- Able to operate under flooded condition
- Microprocessor controller with alternating pump operation and automatic switch-over in case of pump cut out
- Plug-and-go installation with flexible connection options, electronic controls and non-return valves included in the package
- Trouble-free operation that requires a minimum of maintenance due to the products' hard-wearing, non-corroding materials
- Come completely preassembled



Pump performance

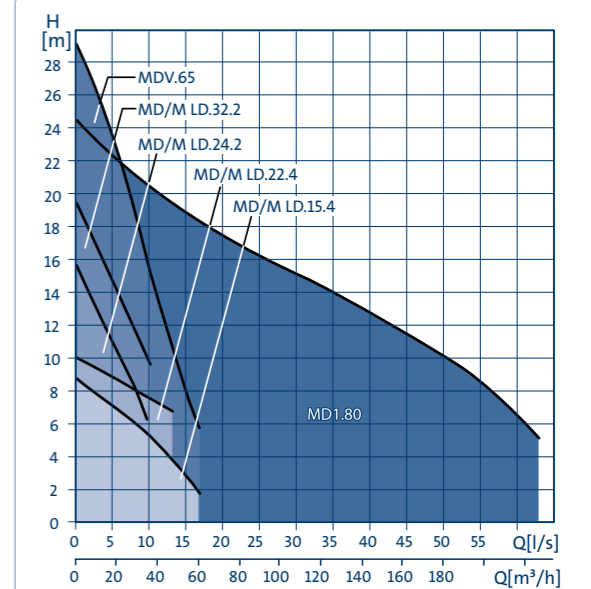

WASTEWATER PRODUCTS LIFTING STATIONS

TAKING POWERFUL EFFICIENCY TO A NEW LEVEL – GRUNDFOS LIFTING STATIONS

Grundfos lifting stations are strong and efficient, completely prefabricated all-in-one solutions that handle both grey and black water. They are used to collect sewage water from below sewer level, lift it above backwater level and carry it to the sewer line. Some key benefits come with all our lifting station solutions:

- Compact design makes it easy to fit the lifting station into the available space
- Durability is a trademark of all our products; we make our lifting stations with resilient, non-corroding materials that keep the products virtually maintenance free
- Backflow protection is guaranteed when the discharge pipe is installed with a bend over the backflow water level
- Fully automatic operation, including supervision by controller and switch to reserve pump in case of extraordinarily high inflow or pump malfunction

Performance chart

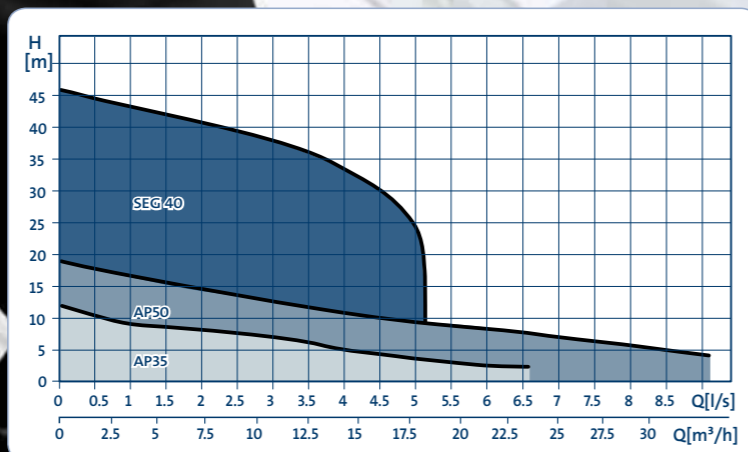

UNOLIFT AND DUOLIFT: LIGHTWEIGHT, ODOUR-FREE COMPLIANCE

These light lifting stations come completely pre-installed and equipped with pumps that are ideal for easy installation inside buildings, where sturdy design and no odour release are critical features. They are perfect for high lifting heads as well as high flow rates up to 32 m³/h, and with their large tank capacities – up to 540 litres for Duolift – these stations will go the distance even in case of power failures.



WASTEWATER PRODUCTS PUMPING STATIONS

PUST: THE ALL-IN-ONE PRE-FABRICATED PUMPING STATION

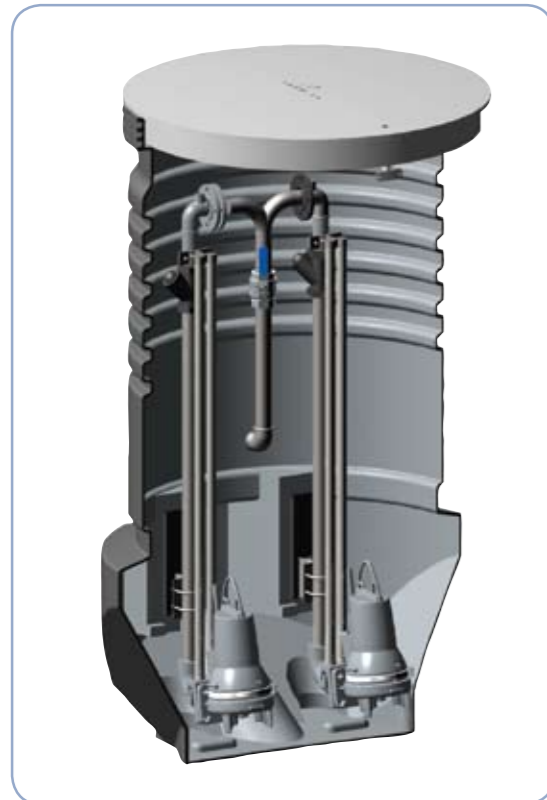

The Grundfos PUST range is designed for the efficient and reliable removal of wastewater from commercial buildings of any size. Our pumping stations are made of durable polyethylene and work perfectly in combination with our selection of quality pumps. They are delivered complete with corrosion-free piping and valves as well as controllers. The PUST range gives you the following benefits:

- Low-weight material means that no heavy lifting device is required in the installation
- Come completely pre-assembled with pipework, valves and coupling systems inside
- The sump design reduces sediments to a minimum
- Level controls are accessible from the top providing easy adjustment from outside the pit
- Guaranteed protection from backflow emergencies
- One supplier means everything meets our high quality standards and fits perfectly together
- Solutions tailor-made by pit diameter, length and pump type



The PUST pumping pits are moulded in one piece and come in sizes from 400 to 1600 mm.

AUTOADAPT3: AUTONOMOUS PIT PUMP CONTROL

With the groundbreaking AUTOADAPT3 pump control, your submersible wastewater pump becomes a completely self-controlled unit with pressure sensors controlling the pumps' start / stop function. AUTOADAPT3 pumps can operate either as stand-alone pumps or in alternate / parallel operation with up to four pumps in the pit.



Features and benefits:

- Easy installation since no level sensors are required
- Plug and pump with one-cable installation
- Completely autonomous solution
- Intelligent operation and monitoring of pumps
- Requires less pit space

The AUTOADAPT3 pump:

- 1 level sensor
- 2 dry-run sensors
- Electrical circuit for start / stop
- Built-in motor protection
- Built-in alarm relay
- Alternate use of up to four pumps
- External communication through a Fieldbus Box (SMS, GPRS, GSM, Modbus)



WASTEWATER PRODUCTS BACKFLOW PROTECTION

WHY YOU SHOULD BE CONCERNED ABOUT BACKFLOW – AND HOW GRUNDFOS CAN KEEP YOU WORRY-FREE

These days, our planet is experiencing violent climate changes that are rapidly transforming the precautions we need to take to stay safe and dry. Heavy rainfall is one of the serious consequences of the climate changes, and as a result, many buildings are at risk of being flooded due to insufficient backflow protection. Fortunately, Grundfos has a solution for that.

Both our Multilift range and our pre-fabricated pumping stations are an excellent choice if you want to conveniently and efficiently safeguard your building. And remember: the cost of a lifting station installation is nothing compared to the trouble and cost of a flooded basement.

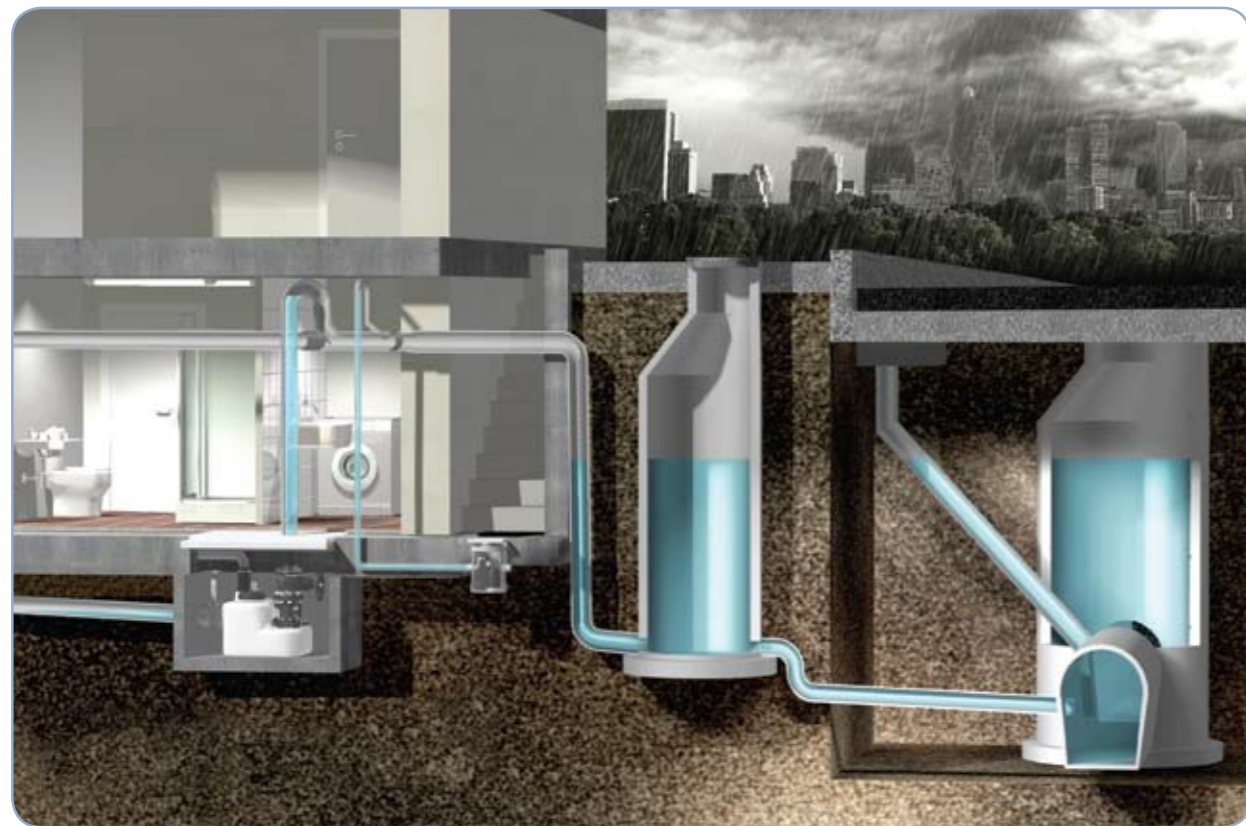

THINKING BUILDINGS

At Grundfos CBS, we are always thinking buildings, and our products contribute to making buildings that can almost think for themselves. We do not just consider our products as stand alone devices – we consider them an integral part of a living building whose purpose is to function in the best way possible for its inhabitants.

Grundfos CBS offers products across the full range of applications, including heating, air conditioning, waste water, booster systems, fire protection systems and district energy.

Our expertise is founded in decades of global experience and we are proud to share our knowledge with our clients. We are also determined to take the lead on new technologies and innovation opportunities.

To learn more about Grundfos CBS and to find out how we can be of assistance, contact Grundfos or visit us at www.grundfos.com/commercialbuilding.

EXPLORE OUR ONLINE UNIVERSE

Make the most of Grundfos CBS – visit the Thinking Buildings Universe at www.grundfos.com/commercialbuilding.

Our website contains a range of services that function as your online Grundfos CBS expert:

- Quick Pump Selection with an extensive product database and dimensioning tool that helps you choose the right pump for your needs
- E-learning programme that lets you improve your specialist knowledge
- Lexicon where you can look up definitions of relevant professional terms

Sign up for Thinking Buildings E-News

Now you can have the latest news on pumps and technology sent straight to your inbox four times a year, including a best of year edition with all our readers' favourite articles.

Welcome to the Grundfos CBS
Thinking Buildings Universe!

