

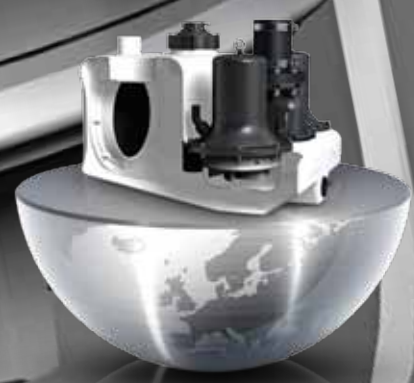

GRUNDFOS

MULTILIFT PRODUCTS

MSS, M, MOG, MD, MLD, MDG AND MD1/V



be
think
innovate

GRUNDFOS 

THE GRUNDFOS MULTILIFT IS A COMPACT, POWERFUL LIFTING STATION THAT OFFERS A COMPLETE WASTEWATER SOLUTION FOR COMMERCIAL BUILDINGS IN ANY TERRAIN

State of the art wastewater removal

A Grundfos MULTILIFT solution gives you no-hassle wastewater disposal in a single, pre-assembled package, complete with a wired controller and fully automatic, low-noise operation guaranteed.

- Special tank, lightweight and extremely pressure stable
- Great capacity
- Patented tank base design
- Powerful, energy efficient pumps
- Leakage and odour free
- Intelligent controls
- Single or double stations
- Clog-free vortex hydraulics
- Fast and clean service
- Highly reliable

PRODUCT OVERVIEW

Product	Product name	Purpose
	MSS/ M/ MOG	One-family houses and installations that do not require a back-up pump
	MD/ MDG	Two- and multiple-family houses, small commercial buildings, offices, schools, restaurants, small hotels etc.
	MLD	Commercial buildings, public areas, offices, schools, hotels, hospitals, restaurants etc.
	MD1/V	Multiple-family houses, large public buildings (hospitals, schools etc.), large commercial buildings (shopping centres etc.), government buildings and industrial buildings.

WHY USE PACKAGED LIFTING STATIONS?

Compact lifting stations for internal installation have been used in modern infrastructures for decades. It is a thoroughly tested technology whose benefits have received increasing attention over the past few years. Grundfos MULTILIFTS are compact, powerful lifting stations that collect any kind of domestic wastewater from any kind of building and lift it onto a higher level in situations where draining by gravity is impossible or can only be realised at great expense.

The most cost-effective way of getting rid of wastewater, from an operational perspective, is gravity. However, in some cases, a gravitational system can benefit greatly from being combined with a MULTILIFT system.

Packaged systems like the MULTILIFT use the gravitational system within an existing building to make its operation much easier. Sometimes, the cost of installing or expanding a gravity drainage system can outweigh the long-term benefits of such a system. In these cases, a packaged lifting station like the MULTILIFT can supplement – or even sometimes replace – a building's gravity draining system using the available basement space inside the building.

A MULTILIFT solution makes costly excavations, re-configuration work and the installation of a deep pit, pumps, level switches, pump wiring and controllers, unnecessary. The MULTILIFT lifting stations are complete solutions – pre-assembled, pre-wired, preset and ready for installation. With footprints between 0,25-2m², they are able to discharge up to 100m³ of wastewater per hour.



WHAT MAKES MULTILIFT THE PREFERRED CHOICE?

The proven MULTILIFT design ensures trouble-free wastewater disposal and comes pre-assembled with a wired controller, ready for installation and fully automatic, low-noise operation.

Cleaning

The patented MULTILIFT tank design efficiently prevents sedimentation and accordingly minimises the need for tank cleaning. Grundfos recommends the use of an optional diaphragm pump that can be used to evacuate the tank for cleaning purposes and secure wastewater removal in case of power breakdown. Furthermore, the tank is accessible through 1 or 2 service cover(s).

No leakage or odour

With a MULTILIFT, leakage is not an issue. The tank and all inlet connectors can withstand a water pressure of at least 5 m, while all connections and connectors on the discharge side will withstand at least 1,5 x max. pump pressure. Additionally, the tight connectors, above the roof tank venting and durable polyethylene tank make the system completely odour-free as has been proven in thousands of installations.

Powerful pumps

The IP68 approved MULTILIFT motors will never let you down – not even in flooded conditions. Designed for dry installation and intermittent operation, each motor can easily handle 60 pump starts per hour, which is completely sufficient for handling domestic wastewater that occurs periodically throughout the day. Two pumps in alternating operation can provide up to 120 pump starts per hour – enough to cover any peak flow situation. The dry installation on the tank enables fast and clean service. For safety reasons, one pump should be sized to handle the total wastewater capacity. This is particularly important in double stations, where the second pump should be regarded as a full backup to achieve system redundancy. Here, the controller ensures alternating operation of the two pumps or parallel operation if the inflow exceeds the capacity of one pump.

Reliability saves money

For lifting stations – even those with large motors – features like clog-free hydraulics, sedimentation-free tanks, easily accessible non-return valves and reliable level sensors are much more important than energy-efficiency. This is because a lifting station typically starts around 10-20 times a day and only runs for a few seconds each time. The cost for servicing clogged units or tanks easily exceeds the total energy cost. MULTILIFT helps you cut costs first by offering features that make servicing almost unnecessary and secondly by being service friendly – for example with improved access to components and easy servicing of the non-return valve.

Fast and clean service

Servicing the MULTILIFT dry installation pumps is easy, fast and clean compared to submersed pit pumps. Just empty the tank with the manual mode on the controller and dismantle the pump.

In double stations, the backup pump will ensure continuous wastewater discharge while the other pump is being serviced.

Single station or double station

Single stations are designed for use in single-family houses to drain basements. Double stations are mandatory for multi-family houses and all kinds of commercial, industrial or public buildings, to conform to EN12056-4. These types of buildings use redundant wastewater disposal systems which make it crucial that the wastewater disposal is not interrupted.

Flooded basements

In a flood situation, the Multilift units continue to operate without problems. MULTILIFT is tested to withstand a flooding height of up to 2m for one week. All components except the controller are IP68 approved.

Tank

The special design of the light, seamlessly moulded polyethylene (PE) tank, with a wall thickness of up to 8mm, makes the MULTILIFT tanks exceptionally pressure stable (pressure proof up to a 5m water column conforming to EN12050-1). The highly wastewater and dirt resistant polyethylene ensures decades of trouble-free operation and the special tank bottom design effectively prevents sedimentation. All MULTILIFT tanks fit through a standard 80cm door, easing retrofit installation considerably. All measurements require the metric to stand next to the number with no gap (in UK). i.e. 80cm, 8mm, 5m, 130l.

Capacity

A compact tank does not mean a low draining capacity. The compact MULTILIFT lifting stations can easily drain entire buildings. The smallest commercial lifting station, the MULTILIFT MD, has a tank capacity of 130l and can discharge up to 5,500l wastewater per hour in single pump operation (the equivalent of wastewater from 15 toilets). A MULTILIFT MLD (270l) discharges up to 11,400l per hour – sufficient even for large buildings.

The small tank sizes also help to combat fouling (including build-up of corrosive substances) and sedimentation caused by age and oversized tanks. Tanks come in different sizes, either 1-pump or 2-pump systems, and are tailored to the application and number of connected appliances.

Which tank size for which building / application?

The right type of wastewater disposal is found by looking at the application type in question as well as the type and number of sanitary appliances. Multilift lifting stations are available with many different tank capacities and motor performances, which means that you can tailor a Multilift for each individual application. To find the right tank size for your application, contact your local Grundfos office. Alternatively, sum up the hourly drain quantity of your connected sanitary appliances and compare with the table on page 13.

Hydraulics

MULTILIFT lifting stations use either vortex or grinder hydraulics. Vortex hydraulics are clog-free, even with longer fibres, while the grinder hydraulics cut solid matter into small pieces that enable the use of pressure pipes as small as 11/4". All hydraulics are self-venting, which ensures easy pump start after service or air aspiration.

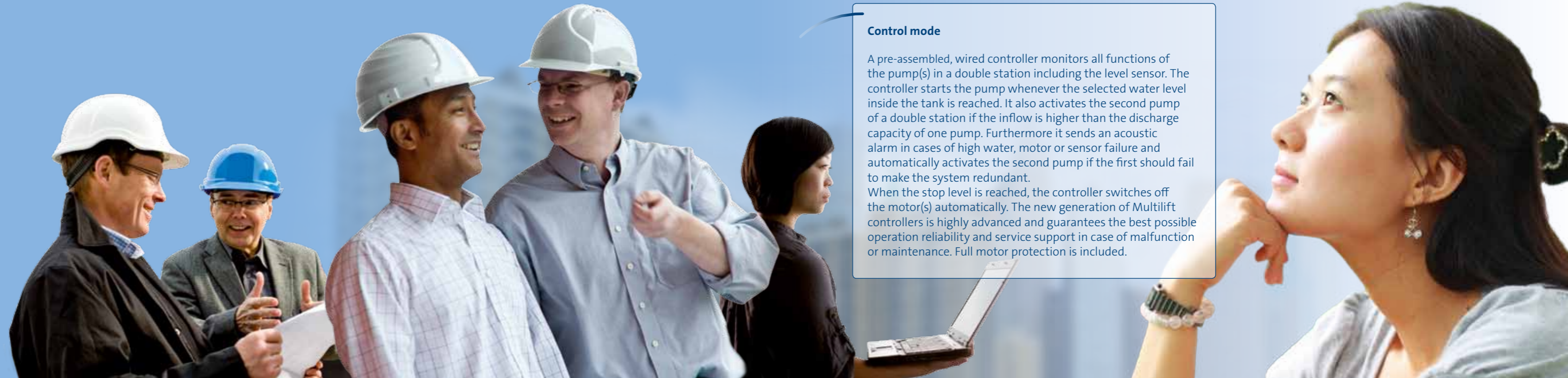

Control mode

A pre-assembled, wired controller monitors all functions of the pump(s) in a double station including the level sensor. The controller starts the pump whenever the selected water level inside the tank is reached. It also activates the second pump of a double station if the inflow is higher than the discharge capacity of one pump. Furthermore it sends an acoustic alarm in cases of high water, motor or sensor failure and automatically activates the second pump if the first should fail to make the system redundant. When the stop level is reached, the controller switches off the motor(s) automatically. The new generation of Multilift controllers is highly advanced and guarantees the best possible operation reliability and service support in case of malfunction or maintenance. Full motor protection is included.

WHEN TO USE MULTILIFT



Don't run the risk of backflow – Grundfos keeps you dry

Heavy rainfall is one of the serious consequences of the violent climate changes that our planet has experienced in recent years. As a result, many buildings are at risk of flooding due to insufficient backflow protection. The result is water logged basements and possibly irreversible losses. Fortunately, Grundfos has a solution. Both our MULTILIFT range and our pre-fabricated pumping stations are an excellent choice if you want to simply and efficiently safeguard your building. Keep in mind that the cost of a lifting station installation is nothing compared to the trouble and cost of a flooded basement.

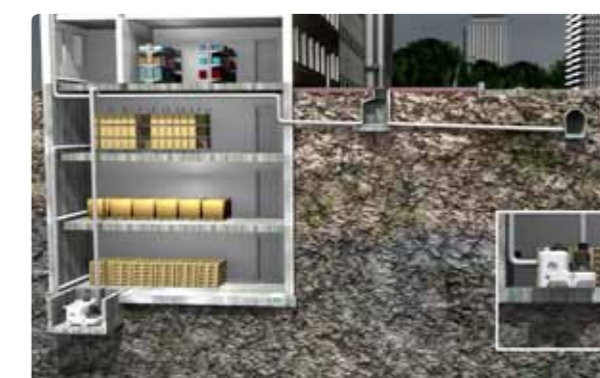
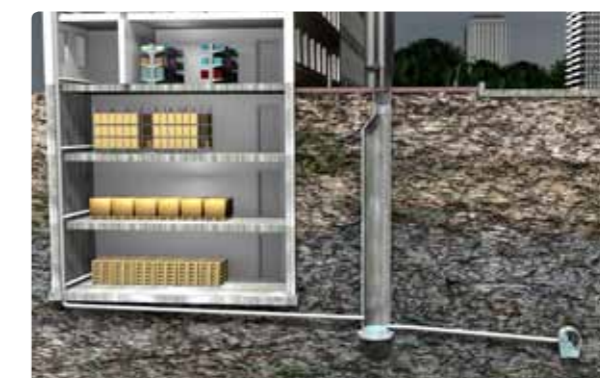
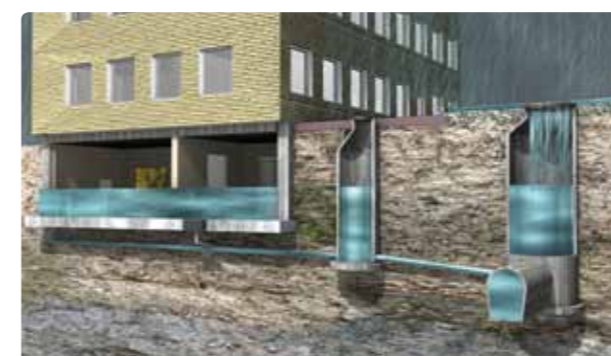

Buildings with basement floors

Use a MULTILIFT solution at the lowest level of a building with one or more basement floors to lift wastewater into the gravity drainage system. This saves the cost of expensive drainpipe excavations under and adjacent to the building, and allows you to place the ground pipe and sewer connection as close to ground level as possible. A further benefit of using MULTILIFT is automatic backwater protection.

Septic tank drainage systems

Instead of using huge tanks whose effective capacity is limited to the volume below the drainpipe connection, a MULTILIFT station takes the wastewater from the basement level and lifts it into the gravity pipe under the basement ceiling. This leads to septic tanks with the same effective capacity but much smaller volume and accordingly much lower installation costs.

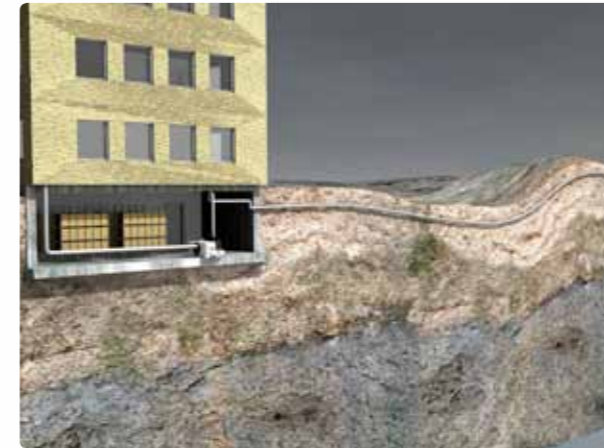

Building conversions

Use a MULTILIFT station for cost-efficient wastewater discharge in buildings where basement levels have been converted (e.g. from office to restaurant). A MULTILIFT solution utilises the existing drainpipes, meaning that you do not have to change pipes outside the building.

Distance to mains

Use a MULTILIFT solution if your building is located away from the mains. In these cases, gravity draining would lead to heavy, costly excavation work and subsequent pipe leakage risks.

Hillside situation

In hilly areas, lifting stations are a cost efficient alternative to pumping stations, which is the solution typically recommended when the use of gravity is impossible.



MULTILIFT IN BRIEF

Complete lifting stations (44l to 1.350l tank capacity)

The MULTILIFT range offers pre-assembled complete lifting stations designed to lift wastewater from below sewer-level in buildings of any size and into the sewer-system. Combining pumps, tanks and controls, they ensure easy installation at the lowest possible cost and offer decades of reliable operation. MULTILIFT lifting stations are suitable for all building types and sizes, both as part of initial designs and retrofits.

Media types

MULTILIFT lifting stations offer you the choice between two different pumping technologies. You can choose free passage for up to 80mm or powerful grinder technology (MOG, MDG). Both technologies reliably discharge domestic wastewater (pH 4 to pH 10) containing solids like fibres, textiles and faeces.



MDG

Container volume: 93l.
Max. Q: 4,5l/s. H: 46m.



MSS

Container volume: 44l.
Max. Q: 10l/s. H: 11,8m



MD

Container volume: 130l.
Max. Q: 16l/s. H: 20,5m



MOG

Container volume: 93l.
Max. Q: 4,5l/s. H: 46m



M

Container volume: 92l.
Max. Q: 16l/s. H: 20,5m



MLD

Container volume: 270l.
Max. Q: 16l/s. H: 20,5m

MULTILIFT AT WORK

For buildings of all sizes

The MULTILIFT range covers buildings of all sizes, from single-family homes to large commercial or industrial buildings. Whatever the scale, MULTILIFT units are designed for compactness, reliability and easy, inconspicuous installation. With a gooseneck / reverse water seal, they will even offer complete backflow protection (see page 4) and guarantee wastewater removal under extreme conditions.

1. MSS/M
2. MD
3. MD/MLD/MDG
4. MD1/V

Getting the right size

Correct sizing of your lifting station is crucial to performance. Sizing tools, installation drawings and instructions are available online at Grundfos WebCAPS and our expert consultants are always ready to help you. The table on the right hand page gives a quick overview of MULTILIFT drainage performance.

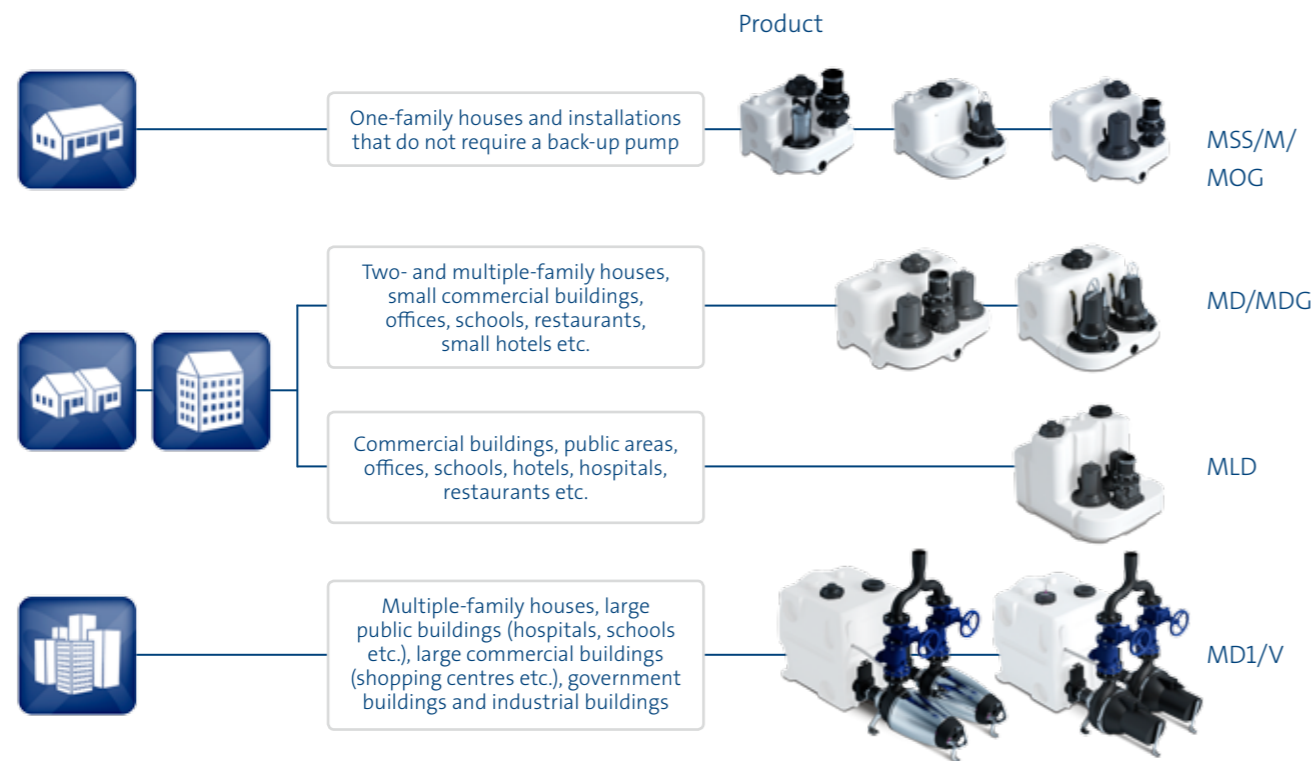

1. MSS/M 2. MD 3. MD/MLD 4. MD1/MDV

DRAINAGE CAPACITY MULTILIFT

	Drain capacity	Number of pumps	Max. number of starts per unit /h **	Peak flow performance***			Max. drain capacity [l/h]* = max. inflow [l/h] according to inlet pipe level and related pump start					
				"DN40 [l/s]"	"DN80 [l/s]"	"DN100 [l/s]"	180mm	250mm	315mm	560mm	450mm	700mm
Single pump units	Multilift MSS	1	40	-	3,5-8	5,6-8	800	1120	-	-	-	-
	Multilift M	1	40	-	3,5-16	5,6-16	1360	1960	2480	-	-	-
	Multilift MOG	1	40	0,5-4,5	-	-	920	1480	2000	-	-	-
Double pump units	Multilift MD	2	60	-	3,5-16	5,6-16	2940	4140	5160	-	-	-
	Multilift MDG	2	60	0,5-4,5	-	-	1380	2220	3000	-	-	-
	Multilift MLD	2	60	-	3,5-16	5,6-16	-	-	-	11400	-	-
	Multilift MD1/MDV with 1 tank	2	60	-	3,5-18	5,6-28	-	-	-	-	7200	14400
	Multilift MD1/MDV with 2 tanks	2	60	-	3,5-18	5,6-28	-	-	-	-	14400	28800
Multilift MD1/MDV with 3 tanks	2	60	-	3,5-18	5,6-28	-	-	-	-	21600	43200	

* Conditions: discontinuous inflow, values are independent from duty point. The effective pump volume discharged each pump cycle depends on height of the start level in the tank and that depends on the physical inlet level of the inlet pipe to the tank.

** for short periods up to 60 pump starts per pump and hour permitted what increases drain capacity [l/h]

*** Depending on respective duty point, for 1 pump operation.





MULTILIFT HIGH POINTS



Plug-and-go

MULTILIFT gives you everything you need – including electronic controls. The all-in-one units are designed to be as compact as possible, with pumps fully integrated in the smaller models. The flexible connection options mean that you can connect your MULTILIFT to inlet, discharge, and ventilation pipes to match your system layout. The wide range of accessories ensures that your final installation is always a perfect fit. In case of underground installation in pits, the unit design secures operation under flooded conditions as well.



Minimal maintenance

The MULTILIFT's robust design and enduring, non-corroding materials make for total reliability and a quiet performance, year after year. The all-in-one MULTILIFT units are fast and easy to install, even in confined spaces, and require very little subsequent service.

Cut construction costs

MULTILIFT units keep construction costs to a minimum because they make excavations for sewers and drainpipe connections outside the building virtually unnecessary. Digging and pump pits are things of the past and you can now easily convert basement areas into toilets and utility rooms with minimum inconvenience. You can also upgrade the wastewater capacity in large buildings in no time.

MULTILIFT high points

Cut costs and improve performance with all-in-one units. The MULTILIFT range combines ingenious design and quality materials to help you cut construction, installation and operating costs.



IMPROVED RELIABILITY

In wastewater handling, operational reliability is crucial. The new and improved MULTILIFT features make this lifting station range the most reliable on the market.

New, improved level detector

- Contact-free and continuous level detecting by on-board piezo-resistive pressure sensor element
- No moving components like floaters that can give rise to blockages when they come into contact with paper or dirty material
- IP68 standard ensures smooth operation even when a lifting station is flooded
- Continuous monitoring of sensor element by a smart controller
- Very easy servicing of sensor tube by thread fixing
- The detector's operation is not sensitive towards dirt
- Well-proven for wastewater applications



Unique, stepless inlet system

- Unique, stepless inlet system renders the previous on-site adjustment work of the lifting station to the inlet pipe obsolete
- The required height can be achieved by simply fixing the screws
- Ideal for initial, retrofit or replacement installation
- 360° rotatable inlet in DN100 and DN150 enables connection of any measurement between 170-315mm (bottom to pipe axis)
- Self-sealing between pipe and inlet system by special gasket (push and seal)



Unique tank bottom design

- Unique tank design with a slope from every corner of the tank to the pump entry
- Avoids sedimentation and hugely reduces the need for tank cleaning
- Reduced risk of tank clogging
- Reduced remaining water volume inside the tank when the pump is switched off



INTELLIGENT CONTROLLERS

The intelligent MULTILIFT controllers come with a wide range of useful functions that make operation and service easy, including a failure log that quickly identifies the root cause of any problem.



Level control 220 for MULTILIFT MSS

Level control 220 (for MULTILIFT MSS)

- Micro controller with interface that allows for software updates
- Automatic pump start / stop and high water alarm
- Indicator for power supply, operation, pump and sensor failures, high water alarm, external alarm, direction of rotation (3 phase only) and maintenance
- Pre-installed piezo-pressure sensor
- Extra terminal to be used for extra sensor outside the lifting station
- Terminal for collective malfunction message (for remote indication)
- Integrated alarm device with battery back-up (optional)
- Easy selectable pump start level via DIP switch
- Motor protection by thermal switch and additional overload protection
- 24h daily test run with system check
- Dry run protection
- Smart panel fixing that makes opening of the controller unnecessary
- Fully wired, pre-adjusted and pre-assembled

Level control 221

The MULTILIFT controllers for commercial applications make installation, operation and maintenance as easy as possible. Features include:

- Menu-operated controller including interface for future updates
- Automatic pump start and stop on selectable levels, alternating pump operation, high water detection and automatic activation of parallel pump operation, redundant control with automatic back-up function
- 2-inch LCD display with backlight
- Indication of operation status: failure log, settings, intervals, operation time, sensor, water level, motor currently used
- Input area and lockable manual switch to avoid unauthorised use
- Dry run protection
- Integrated alarm device with battery back-up (optional)
- Start levels selectable by menu
- Impulse and hour counter integrated



Level control 221 for MULTILIFT MD, MDG, MLD and MD1/V, duplex units



Level control 221 for MULTILIFT M and MOG, single station

- Failure log for the last 20 events
- Full motor protection by thermal and electronic current control
- Daily test run with system check
- Real-time level sensor control
- Several kinds of alternative level sensor connection (optional)
- External terminal for extra float switch, e.g. moisture sensor
- Potential free terminals for operation pump 1 and / or 2, failure pump 1 and 2, high water alarm, common failure alarm, ability to quit alarms from the Building Management System.
- Stand by 2W
- Integrated capacitors on all single-phase stations
- Smart panel fixing

MULTILIFT SINGLE STATIONS – UNCOMPROMISING QUALITY

The MULTILIFT units perform a crucial task: collecting wastewater and bringing it to the sewer system. This demands much in terms of reliability, performance – and ease of installation. Explore some of the key features here. For details on technical specifications, materials, performance and more, see the data booklet. MULTILIFT lifting stations are certified and tested by several external institutes to conform to the exacting standards.



Best size performance

A range of single stations is available to suit the varying demands in domestic applications. With three different tank sizes (44l to 93l) and six motor sizes in single and three-phase versions, a MULTILIFT single station can be tailored to fit the wastewater disposal needs in everything from single-family houses to light commercial buildings.

Complete units

MULTILIFT single stations are complete units with a motor, sensor unit, wired controller and non-return valve – ready for installation on delivery. Installation accessories like flexible connectors for the discharge and venting pipes, inlet pipe gasket seals, clamps etc., are included.

Recommended accessories

Useful accessories like the PVC gate valve simplify handling and installation by reducing weight. Gate valves for inlet and discharge are mandatory for installation and conform to the EN12056 standard. Grundfos also recommends installing a diaphragm pump.

Level sensors – contact-free technology

The MULTILIFT offers permanent level detection with no contact to the wastewater. Piezo-pressure sensors detect wastewater levels inside the tank in real-time – without moving parts or submersion which eliminates the risk of sensor blockage. Level sensor is fully monitored by the intelligent MULTILIFT controller.

Multiple horizontal and vertical inlets

Select horizontal or vertical inlet options to suit your project's specific conditions – and with sockets or sealed bushings from DN50 to DN150, there are plenty of connection possibilities. The unique rotatable inlet on MULTILIFT M and MOG enables stepless inlet level adaption between 170-315 mm.

Smart control

The intelligent MULTILIFT controllers are packed with useful functions: a reliable liquid level indicator, automatic start/stop on selectable levels, a high water alarm, motor protection, dry run protection, a built-in alarm with battery backup, daily test run, rotation control etc. You can even connect an additional level switch to monitor the installation's surroundings.

Reliable wastewater handling

The self-venting, stainless steel pumps with vortex impellers and 50mm free passage ensure that MULTILIFT single stations will reliably discharge wastewater and solids. With its robust motor design capable of up to recommended 30 pump starts per hour, a single station has a drain capacity of 1860 l per hour – more than enough for any domestic application. Motor protection is built-in and the pump can easily be removed for service checks.

Higher heads

Equip your single station with a Grundfos SEG grinder pump to discharge heads up to 45 m with 1 1/2" pipes.

Low-noise operation

In some applications, noise can be a major concern. The MULTILIFT units are designed for efficient, low-noise operation.

Gas, odour and pressure proof

The combination of quality materials like airtight polyethylene and careful manufacturing ensures reliable operation without gas or odour leaks. MULTILIFT lifting stations can withstand an inner pressure of a 5m water column and are completely water and pressure tight. The seamless polyethylene tanks are absolutely odour tight and corrosion resistant for enduring reliability and performance.



MULTILIFT DUPLEX STATIONS – SOLUTIONS FOR COMMERCIAL APPLICATIONS

MULTILIFT MD, MLD and MDG are prefabricated duplex stations that ensure mandatory wastewater system redundancy in commercial buildings and multi-family houses. Their high-quality components and intelligent design make them just as reliable as traditional gravity drainage.



A perfect fit

Our flexible duplex stations can be tailored to fit buildings of any type and size. With tank capacities between 92-270l and 6 different motor sizes, the MD, MLD and MDG units are perfectly suited for small to mid-size buildings with a wastewater quantity of up to 11.400l per hour. All units are available with either single or three-phase motors.

Intelligent controllers

The MULTILIFT controllers have a wide range of useful functions that make operation and service easy, including a monitoring system, which protects all vital parts of the pump as well as identifying and communicating any faults. See page 19 for a detailed description of the controllers.

Contact-free level detection

The MULTILIFT offers permanent level detection with no contact to the wastewater. The smart piezo-pressure sensor detects wastewater levels inside the tank in real-time – without moving parts or submersion. This significantly increases reliability and prevents sensor blockage that can be typical for floaters systems. The thread lock makes it easy to remove the sensor tube for service. Level sensor is fully monitored by the intelligent MULTILIFT controller.

Easy access to non-return valve

MULTILIFT lifting stations have their non-return valve units built onto the tank. The advantage of this easy access is clear. An inspection cover allows for simple valve checks and removal of foreign bodies, while the design ensures that access to the valve does not require any costly and time-consuming dismantling.

Quick and easy installation

All duplex stations are fully pre-assembled and ready for installation with a wired controller, sensor and pumps. All necessary accessories for connecting the inlet, discharge and venting pipes are included. The double non-return valve is pre-installed on the MD and MLD models, and can be selected from the accessories list for the MDG with grinder pumps.

Flexible, multiple inlets

Besides prefabricated DN100 and DN150 inlet connections on the tank sides, MULTILIFT MD and MOG units feature a unique main inlet system that enables alignment of the stepless inlet pipe. This renders time-consuming adjustments unnecessary, which is particularly useful when installation space is limited. The flexible, multiple inlets make MULTILIFT ideal both for new buildings and retrofits / replacements.

Sedimentation-free tanks

The sloping tank bottom design ensures that dirt and solids are guided towards the pump at all times. This minimises sedimentation and reduces the need for tank cleaning, as well as the cost.

Robust tanks made for life

The lightweight, non-adhesive and wastewater resistant polyethylene (PE) is slowly becoming the tank material of choice in wastewater systems. This excellent material will also withstand 50°C wastewater (up to 90°C for short periods). The special MULTILIFT tank design and seamlessly moulded PE makes for a completely pressure stable and odour-free tank that can easily handle pressure up to a 5m water column without leakage. With MULTILIFT, you get a tank that is ready for decades of trouble-free operation.

Clog-free pumps

With MULTILIFT, you are free to choose the self-venting hydraulics that best fit your purposes. Choose tried and tested vortex hydraulics with a large free passage or the robust SEG grinder pumps for reliable wastewater disposal day after day. MULTILIFT MD and MLD with vortex hydraulics can handle larger amounts of wastewater and be combined with DN80 or DN100 discharge pipes. MULTILIFT MDG with grinder hydraulics that cut solids, can lift heads up to 45m and allows for use of pressure pipes as small as 11/4".



HEAVY DUTY – MEET MD1/V

MULTILIFT MD/1V is designed for the heaviest wastewater lifting jobs imaginable. Equipped with our SE or SL pump, its continuous operation mode lets you use it for both wastewater removal and more difficult tasks like rainwater handling.



Comfortable control

MULTILIFT units are supplied with intelligent control units that feature pump alternation, daily test runs, motor protection and rotation direction control – and these are only some of the many useful functions. (For more details see page 17). MULTILIFT lifting stations are certified and have been tested by several external institutes to verify that they conform to the exacting standards.

High class level sensor

The piezo-resistive pressure sensor is fully monitored by the MULTILIFT control unit and offers continuous level detection without the risk of blocking moving sensor parts. Combined with the flat front tank design for variable inlet selection it enables the smart level sensor to adjust easily to individual starting levels.

Go bigger

The MD1/V offers tank volumes from 450 l (one tank) all the way up to 1.350 l (three tanks). If you need more capacity, simply add one or two extra tanks.

Flexible horizontal connection

Select horizontal connection options to suit your specific needs. Up to three inlet sockets (DN150) and space for additional on-site inlet (DN150) thanks to the flat front design.

Gas, odour and pressure proof

The combination of quality materials like airtight polyethylene and careful manufacturing ensures reliable operation without gas or odour leaks. MULTILIFT lifting stations can withstand an inner pressure of a 5 m water column and are completely water and pressure tight. The seamless polyethylene tanks are absolutely odour tight and corrosion resistant for enduring reliability and performance.

Pump performance

MD1/V is available with two pump ranges – SE for both continuous and intermittent operation, and SL for only intermittent operation. Both ranges come with either single channel (SE1/SL1) or vortex (SEV/SLV) impellers. SE1/SL1 utilise the unique Grundfos S-tube impeller and ensure a constant, superior efficiency over time that guarantees the best solid handling.



Maintenance and service friendly

- Mechanical shaft seal cartridge with two silicon carbide (SiC) shaft seals per cartridge
- Hermetically sealed cable plug
- Stainless steel housing clamp for quick motor dismantling

The right accessories

A wide range of available accessories with items like the PVC gate valve or Y-branch pipe, helps you simplify handling and installation. Note that all valves are accessories.

Less sedimentation

The patented tank bottom design with chambers that direct wastewater to the suction side of the pumps minimises sedimentation and the risk of blockage – and this keeps maintenance costs low. The design also helps to avoid residual water in the tank, when the pump is switched off.





MULTILIFT MSS

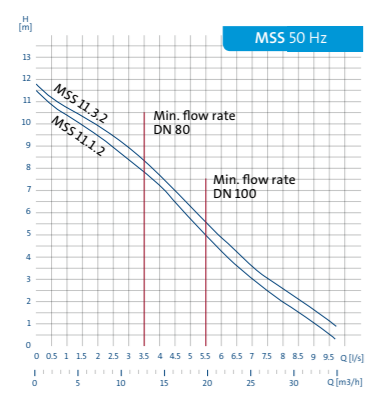

ISO 9906 Grade 3

MULTILIFT M

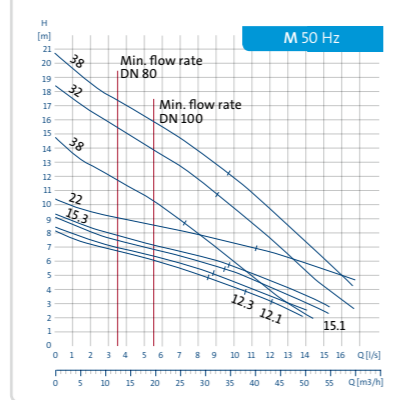

MULTILIFT MOG

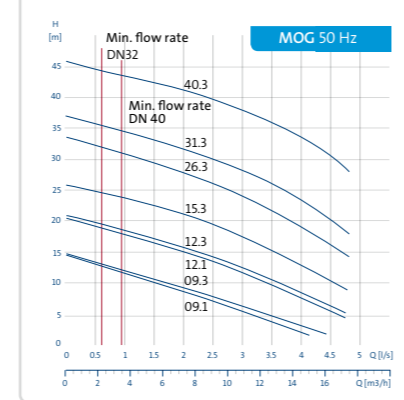

MULTILIFT MD

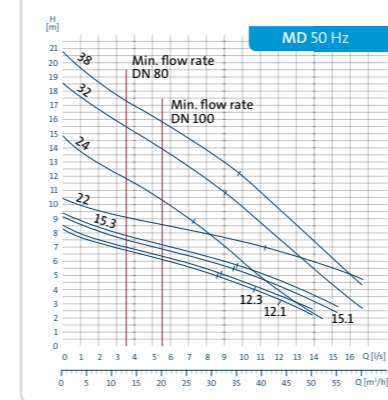

ISO 9906 Grade 3

MULTILIFT MLD

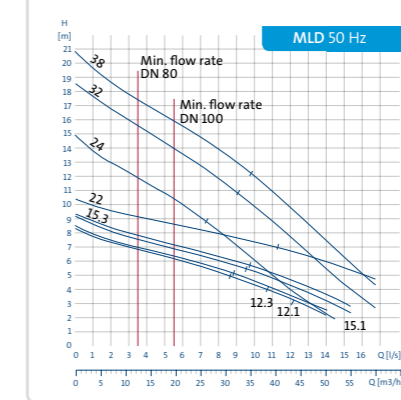

MULTILIFT MDG

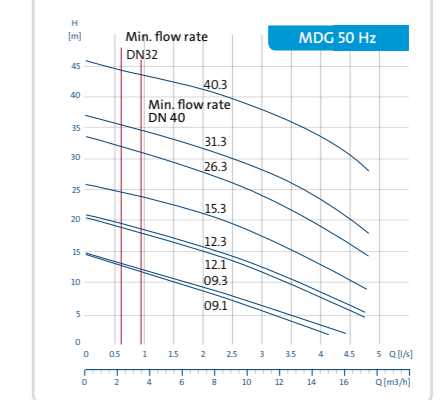

MULTILIFT MSS/M/MOG SINGLE PUMP UNITS

MULTILIFT MSS/M/MOG	Inlet level [mm]	Tank volume [l]	Effective pump volume [l]	Duty	Voltage [V]	Power P1 / P2 [kW]	I1 / Istart [A]	RPM [min-1]	Number of poles	Plug type	Cable length controller to motor [m]	Weight [kg]	Product number
MSS.11.1.2	180 / 250	44	20 / 28	S3-10%, 1 min.	1 x 230V	1,8 / 1,1	8 / 22,5	2760	2	Schuko	4	28	97901037
MSS.11.3.2					3 x 400V		3,2 / 16			2785			CEE 3P+N+E, 16A
M.12.1.4	180 / 250 / 315	93	34 / 49 / 62	S3-50%, 1 min.	1 x 230V	1,9 / 1,4	9 / 38	1430	4	Schuko	4	69	97901064
M.12.3.4					3 x 400V		1,8 / 1,5			3,7 / 19			CEE 3P+N+E, 16A
M.15.1.4					1 x 230V		2,3 / 1,7	10,1 / 39	1410	4	Schuko	97901066	
M.15.3.4					3 x 400V		2,3 / 1,8	4 / 19			CEE 3P+N+E, 16A	97901067	
M.22.3.4					3 x 400V		2,8 / 2,3	5,5 / 29,7	1430	4	CEE 3P+N+E, 16A	97901068	
M.24.3.2					3 x 400V		3,1 / 2,6	5,5 / 39	2920		CEE 3P+N+E, 16A	97901070	
M.32.3.2	3 x 400V	4,0 / 3,4	6,7 / 39	2920	2	CEE 3P+N+E, 16A	97901072						
M.38.3.2				S3-40%, 1 min.	3 x 400V	4,6 / 3,9	7,5 / 39	2880	2	CEE 3P+N+E, 16A		72	97901074
MOG.09.1.2	180 / 250 / 315	93	23 / 37 / 50	S3-35%, 1 min.	1 x 230V	1,4 / 0,9	6,3 / 38	2890	2	Schuko	10	62	97901124
MOG.09.3.2					3 x 400V		2,6 / 21			2860			CEE 3P+N+E, 16A
MOG.12.1.2					1 x 230V		8,2 / 38	2820	2820	2	Schuko	97901126	
MOG.12.3.2					3 x 400V		1,8 / 1,2	3,1 / 21			CEE 3P+N+E, 16A	97901127	
MOG.15.3.2					3 x 400V		2,3 / 1,5	3,8 / 21	2700	2	CEE 3P+N+E, 16A	97901128	
MOG.26.3.2					3 x 400V		3,7 / 2,6	5,3 / 33	2870		CEE 3P+N+E, 16A	97901130	
MOG.31.3.2					3 x 400V		3,9 / 3,1	6,3 / 43	2900	2	CEE 3P+N+E, 16A	97901132	
MOG.40.3.2					3 x 400V		5,2 / 4,0	8,2 / 43	2830		CEE 3P+N+E, 16A	97901134	

- MSS and M are available with 10 m cable
 - M and MOG are available with turnable inlet disk DN150 instead of DN100
 - M and MOG are available in 3 x 230V versions

Please ask your local Grundfos representative.

MULTILIFT MD/MLD/MDG DOUBLE PUMP UNITS

MULTILIFT MD	Inlet level [mm]	Tank volume [l]	Effective pump volume [l]	Duty	Voltage [V]	Power P1 / P2 [kW]	I1 / Istart [A]	RPM [min-1]	Number of poles	Plug type	Cable length between controller and motor on tank [m]	Weight [kg]	Product number					
MD.12.1.4	180 / 250 / 315	130	49 / 69 / 86	S3-50%, 1 min.	1 x 230V	1,8 / 1,5	9 / 39	1430	4	CEE 2P+E 32A	4	119	97901084					
MD.12.3.4					3 x 400V		3,7 / 19			CEE 3P+N+E, 16A			97901085					
MD.15.1.4					1 x 230V		10,1 / 39	1410		4			CEE 2P+E 32A	97901086				
MD.15.3.4					3 x 400V		4 / 19						CEE 3P+N+E, 16A	97901087				
MD.22.3.4					3 x 400V		2,8 / 2,3	5,5 / 29,7		1430			2	CEE 3P+N+E, 16A	121	97901088		
MD.24.3.2					3 x 400V		3,1 / 2,6	5,5 / 39		2920				CEE 3P+N+E, 16A	97901090			
MD.32.3.2				3 x 400V	4,0 / 3,4	6,7 / 39	2920	2	CEE 3P+N+E, 16A	126	97901092							
MD.38.3.2				3 x 400V	4,6 / 3,9	7,5 / 39	2880		CEE 3P+N+E, 16A	97901094								
MLD.12.1.4				560	270	190	S3-50%, 1 min.	1 x 230V	1,8 / 1,5	9 / 39	1430	4	CEE 2P+E 32A	4	130	97901104		
MLD.12.3.4								3 x 400V		3,7 / 19			CEE 3P+N+E, 16A			97901105		
MLD.15.1.4								1 x 230V		10,1 / 39	1410		4			CEE 2P+E 32A	97901106	
MLD.15.3.4								3 x 400V		2,3 / 1,8						4 / 19	CEE 3P+N+E, 16A	97901107
MLD.22.3.4	3 x 400V	2,8 / 2,3	5,5 / 29,7					1430		2	CEE 3P+N+E, 16A		132			97901108		
MLD.24.3.2	3 x 400V	3,1 / 2,6	5,5 / 39					2920			CEE 3P+N+E, 16A		97901110					
MLD.32.3.2	3 x 400V	4,0 / 3,4	6,7 / 39				2920	2	CEE 3P+N+E, 16A	136	97901112							
MLD.38.3.2	3 x 400V	4,6 / 3,9	7,5 / 39				2880		CEE 3P+N+E, 16A	97901114								
MDG.09.1.2	180 / 250 / 315	93	23 / 37 / 50				S3-35%, 1 min.	1 x 230V	1,4 / 0,9	6,3 / 38	2890	2	Schuko	10	106	97901136		
MDG.09.3.2								3 x 400V		2,6 / 21			2860			CEE 3P+N+E	97901137	
MDG.12.1.2								1 x 230V		8,2 / 38	2820		2820			2	CEE 2P+E 32A	97901138
MDG.12.3.2								3 x 400V		1,8 / 1,2	3,1 / 21						CEE 3P+N+E, 16A	97901139
MDG.15.3.2				3 x 400V	2,3 / 1,5	3,8 / 21		2700		2	CEE 3P+N+E, 16A		108			97901140		
MDG.26.3.2				3 x 400V	3,7 / 2,6	5,3 / 33		2870			CEE 3P+N+E, 16A		97901142					
MDG.31.3.2				3 x 400V	3,9 / 3,1	6,3 / 43	2900	2	CEE 3P+N+E, 16A	166	97901144							
MDG.40.3.2				3 x 400V	5,2 / 4,0	8,2 / 43	2830		CEE 3P+N+E 32A	97901146								

- MD and MLD are available with 10 m cable
 - MD and MDG are available with turnable inlet disk DN150 instead of DN100
 - MD and MDG are available in 3 x 230V versions

Please ask your local Grundfos representative.

MULTILIFT MSS

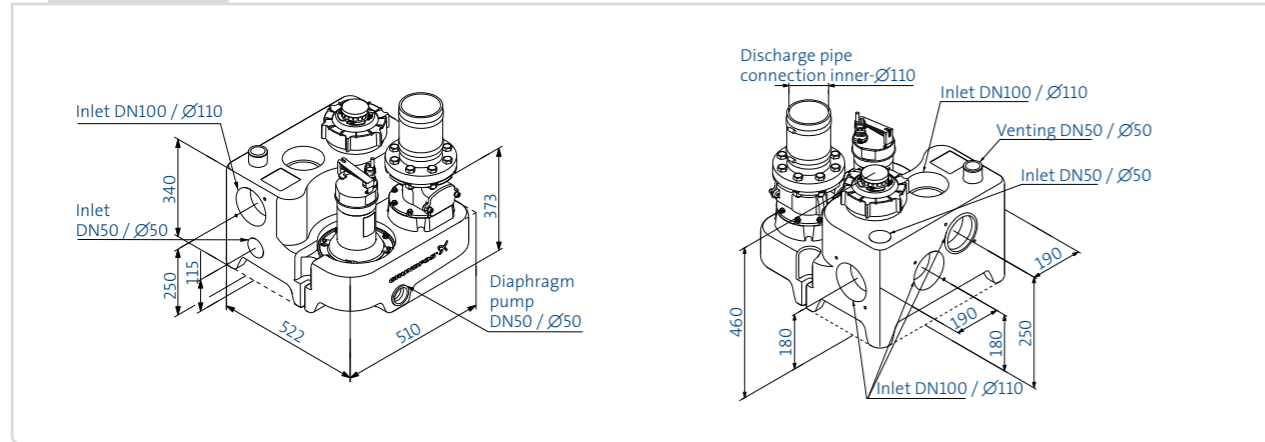

MULTILIFT MD

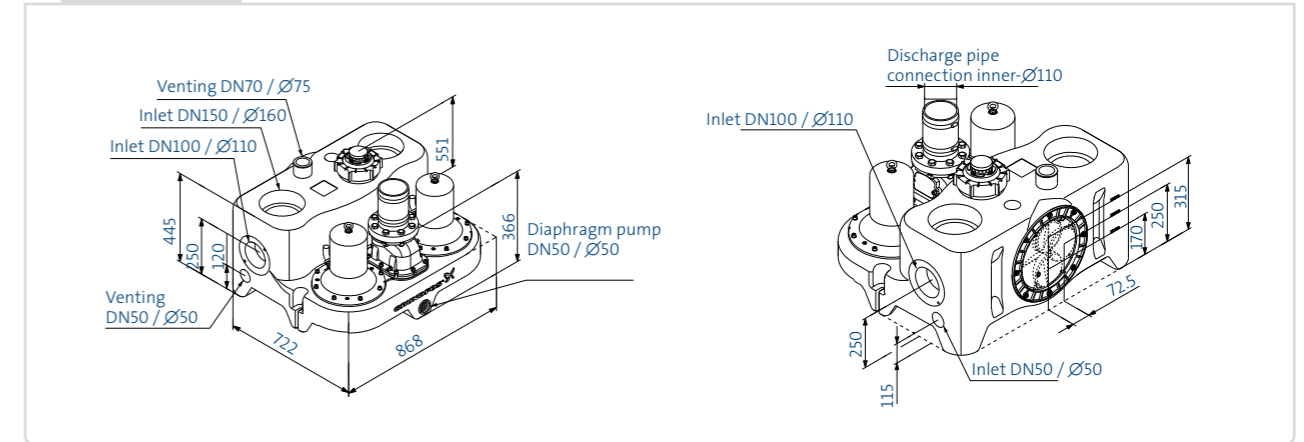

MULTILIFT M

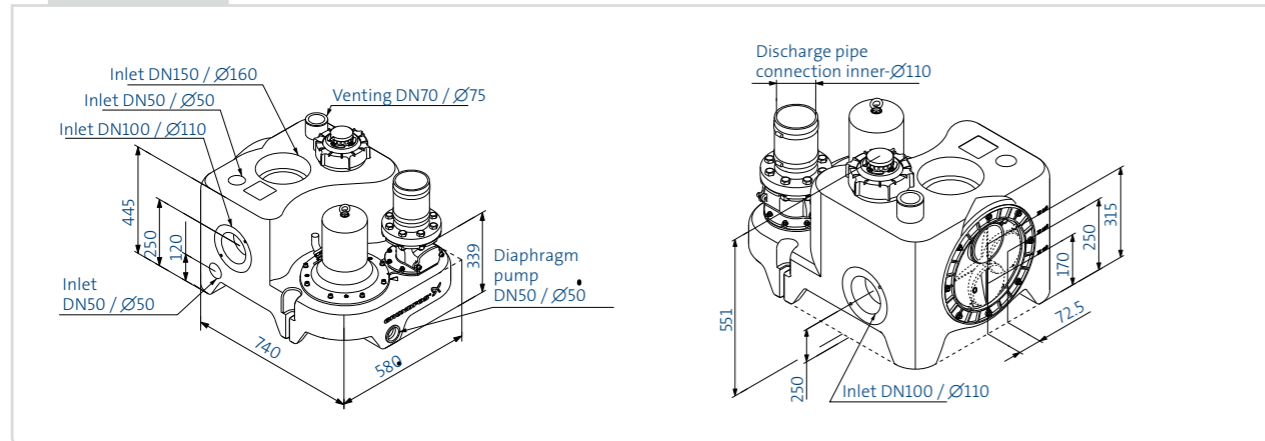

MULTILIFT MLD

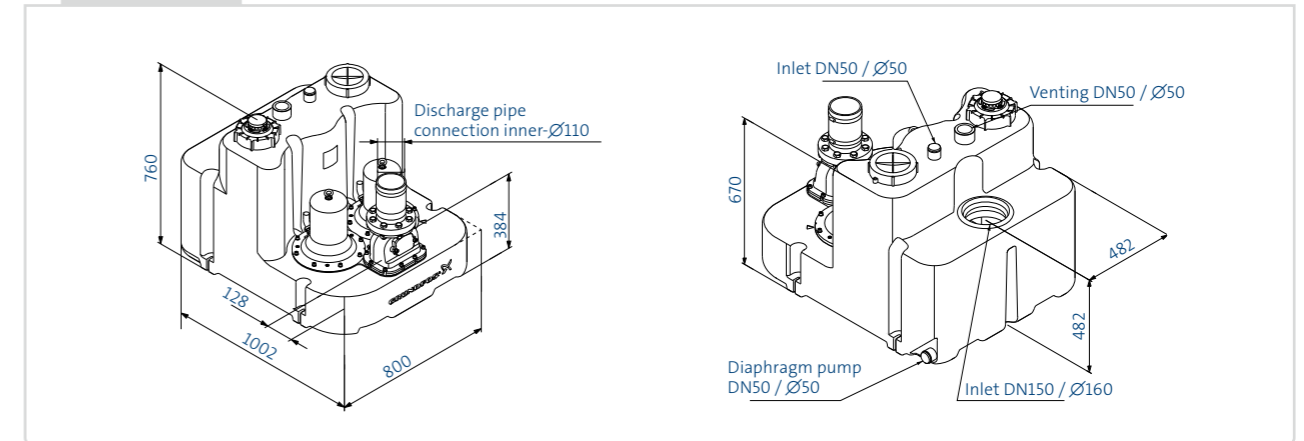

MULTILIFT MOG

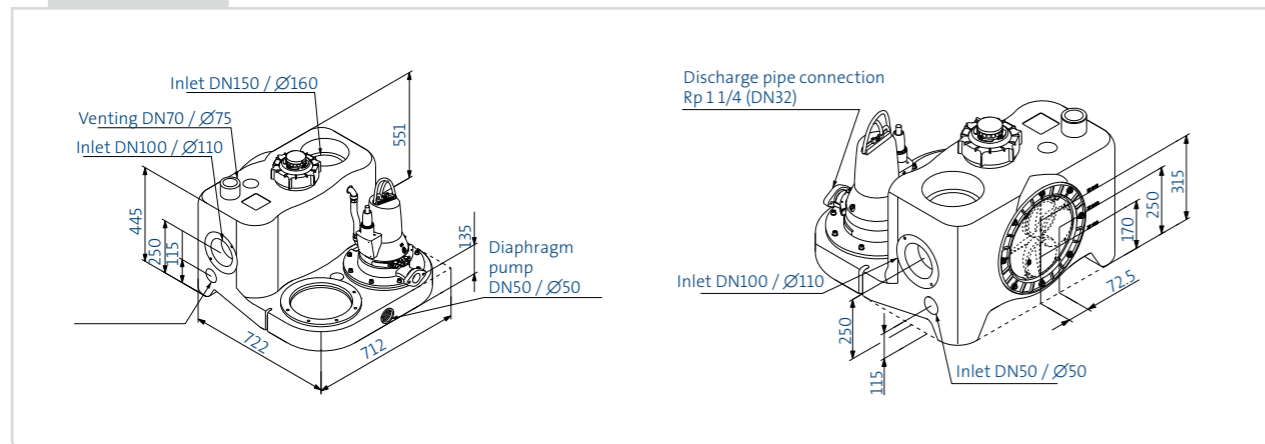

MULTILIFT MDG

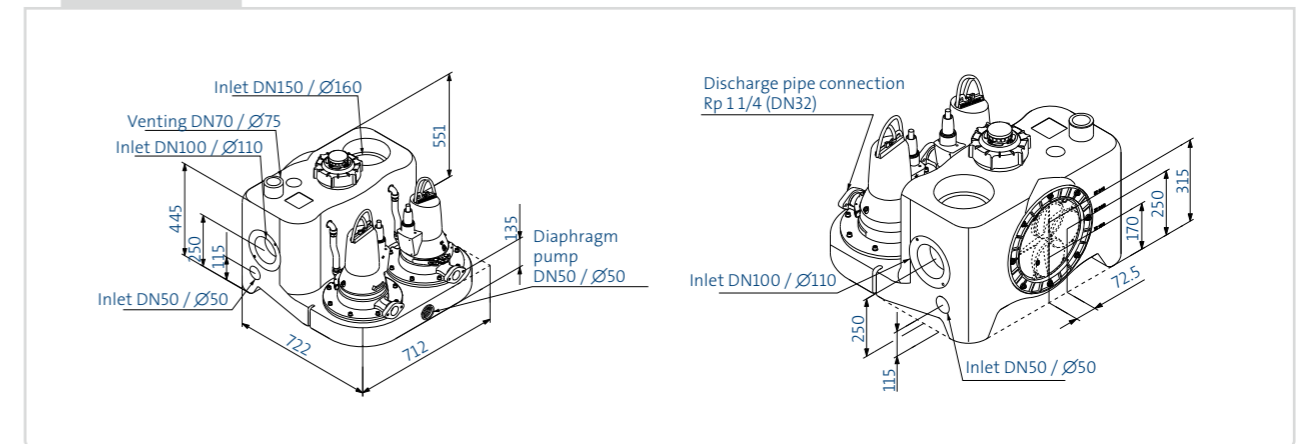

Scope of delivery:

MULTILIFT MSS, M, MD, MLD

Are delivered with a tank including pump(s), a wired controller with a 4m cable to the pump and 4m hose to the ram pressure tube to the tank, 1.5m cable with plug to the power supply, wired sensor unit, mounted non-return valve (MSS, M) or butterfly non-return valve (MD, MLD), a discharge flange with connection piece DN100, mounting kit (gasket DN80, bolts, nuts, washers), flexible connection hose with 2 clamps DN100, flexible connection hose with 2 clamps DN70 (DN50 only for MSS) for venting, DN50 socket sealing for diaphragm pump or additional inlet and the inlet socket sealing DN100 for MSS, M, MD and DN150 for MLD. MULTILIFT M and MD are equipped with a turnable inlet disk which can be replaced with an inlet disk DN150 (see accessories).

Scope of delivery:

MULTILIFT MOG, MDG

Are delivered with a tank including grinder pump(s) with oval flanges to connect discharge pipe 1 1/4" and valves (see accessories). MOG and MDG incorporate a wired controller with a 4m cable to the pump and 4m hose to the ram pressure tube to the tank, 1.5m cable with plug to the power supply, wired sensor unit, flexible connection hose with 2 clamps DN70 for venting, DN50 socket sealing for diaphragm pump or additional inlet, and a turnable inlet disk with socket sealing DN100. This disk can be replaced with an inlet disk DN150 (see accessories).

MULTILIFT MD1/MDV WITH SE PUMPS



SE pumps are developed for continuous duty (S1) and for intermittent duty (S3-50%, 1 min.)

TECHNICAL DATA MULTILIFT MD1 – DOUBLE PUMP UNITS WITH TWO TANKS

MULTILIFT (with single impeller pumps)	Inlet level [mm]	Number of tanks and volume [l]	Effective pump volume [l]	Power P1 / P2 [kW]	l1/1 / Istart [A]	Number of poles	Voltage [V]	Starting method	Weight [kg]	Product number
MD1.80.100.15.4	700 / 840	2 x 450	480	2,1 / 1,5	4,2 / 22	4	3x380-415	D.O.L	340	96102292
MD1.80.100.22.4				2,9 / 2,2	5,9 / 32				340	96102294
MD1.80.100.30.4				3,7 / 3,0	7,8 / 43				428	96102296
MD1.80.100.40.4				4,9 / 4,0	10,0 / 67			463	96102298	
MD1.80.100.55.4				6,5 / 5,5	13,4 / 87			473	96102300	
MD1.80.100.75.4				9,0 / 7,5	17,3 / 107			565	96102302	

MULTILIFT MD1/MDV are available as a variant with an inlet DN200 instead of DN150. Please ask your local Grundfos representative.

MULTILIFT MDV

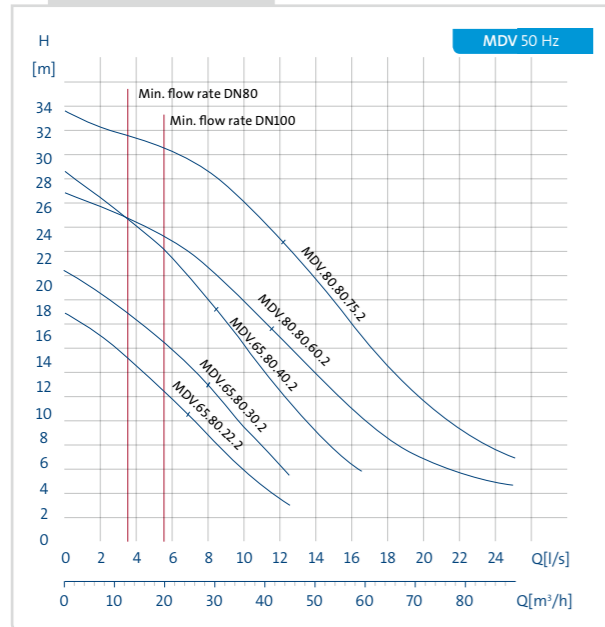

MULTILIFT MD1.80

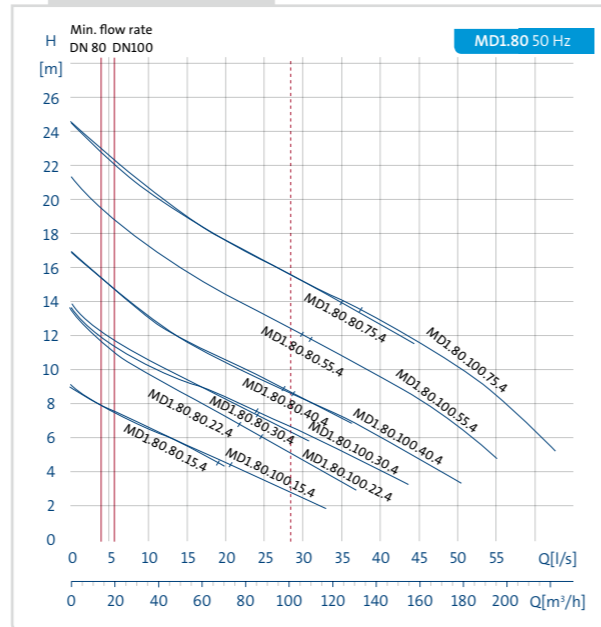

ISO 9906 Grade 2

TECHNICAL DATA MULTILIFT MDV – DOUBLE PUMP UNITS WITH ONE TANK

MULTILIFT (with vortex impeller pumps)	Inlet level [mm]	Number of tanks and volume [l]	Effective pump volume [l]	Power P1 / P2 [kW]	l1/1 / Istart [A]	Number of poles	Voltage [V]	Starting method	Weight [kg]	Product number
MDV.65.80.22.2	700 / 840	1 x 450	240	2,8 / 2,2	5,0 / 37	2	3x380-415	D.O.L	280	96102274
MDV.65.80.30.2				3,8 / 3,0	6,6 / 51				280	96102276
MDV.65.80.40.2				4,8 / 4,0	8,6 / 71				320	96102278
MDV.80.80.60.2				7,1 / 6,0	13,9 / 148			335	96776520	
MDV.80.80.75.2				8,9 / 7,5	16,2 / 152			336	96741485	

TECHNICAL DATA MULTILIFT MD1 – DOUBLE PUMP UNITS WITH ONE TANK

MULTILIFT (with vortex impeller pumps)	Inlet level [mm]	Number of tanks and volume [l]	Effective pump volume [l]	Power P1 / P2 [kW]	l1/1 / Istart [A]	Number of poles	Voltage [V]	Starting method	Weight [kg]	Product number
MD1.80.80.15.4	700 / 840	1 x 450	240	2,1 / 1,5	4,2 / 22	4	3x380-415	D.O.L	300	96102280
MD1.80.80.22.4				2,9 / 2,2	5,9 / 32				300	96102282
MD1.80.80.30.4				3,7 / 3,0	7,8 / 43				360	96102284
MD1.80.80.40.4				4,9 / 4,0	10,0 / 67			380	96102286	
MD1.80.80.55.4				6,5 / 5,5	13,4 / 87			390	96102288	
MD1.80.80.75.4				9,0 / 7,5	17,3 / 107			490	96102290	

MULTILIFT MD1/MDV – double pump units with one tank

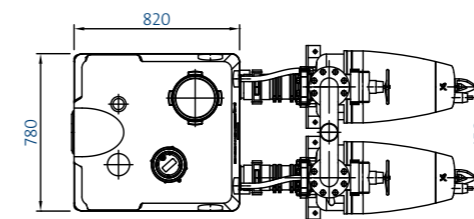

Installation possibilities:

1. Cast iron gate valve
2. PVC gate valve (accessory)

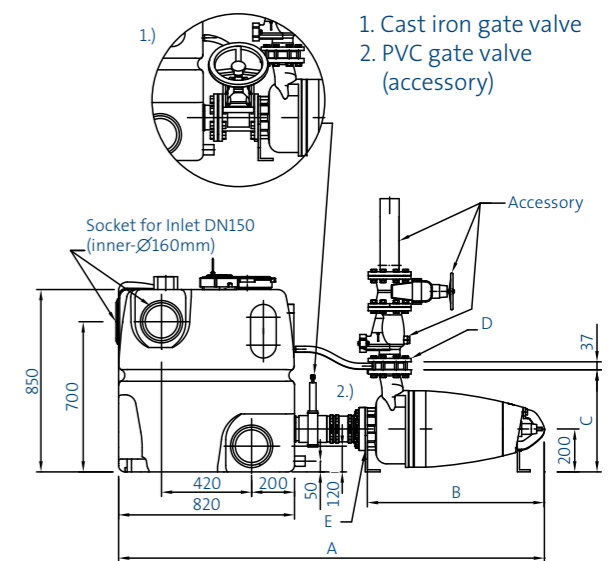

MULTILIFT MD1 – double pump units with two tanks

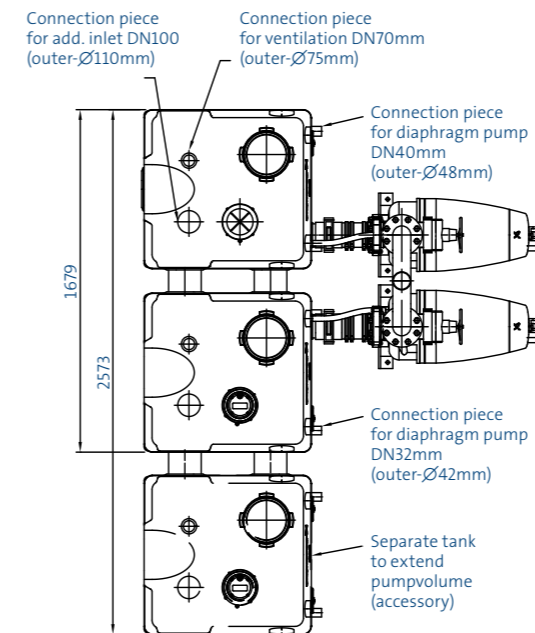

DIMENSIONS MD1/MDV

MULTILIFT	P1 [kW]	Dimensions [mm]					
		A ¹⁾	A ²⁾	B	C	D	E
MDV.65.80.22./30.2	2,8-3,8	1800	1890	726	447	DN80	
MDV.65.80.40.2	4,8	1870	1950	791	476		
MDV.80.80.60.-75.2	8,9	1895	1975	816	476		
MD1.80.80.15-22.4	2,1-2,9	1910	1980	723	472	DN100	
MD1.80.80.30.-55.4	3,7-6,5	2005	2080	820	519		
MD1.80.80.75.4	9	2060	2135	876	528		
MD1.80.100.15-22.4	2,1-2,9	1910	1980	723	472	DN100	
MD1.80.100.30.-55.4	3,7-6,5	2060	2135	820	519		
MD1.80.100.75.4	9	2060	2135	876	528		

¹⁾ Cast iron gate valve – ²⁾ PVC gate valve

Scope of delivery:

MULTILIFT MD1/MDV

Are delivered with one or two tanks, SE or SL pumps with horizontal installation kit, two socket sealings DN100 and flange with connection piece for pump connection, controller with a 10m cable, 10m hose to the ram pressure tube, flexible connection hose with 2 clamps DN40 for diaphragm pump connection, flexible connection hose with 2 clamps DN70 (venting) and inlet socket sealing DN150. MULTILIFT MD1.80.100 is delivered with two tanks and the connection pieces and seals in between the collecting tanks.

MULTILIFT MD1/MDV WITH SL PUMPS



SL pumps are developed for intermittent duty (S3-50%, 1 min. at ambient temp. of max. 30°C)



TECHNICAL DATA MULTILIFT MD1 – DOUBLE PUMP UNITS WITH TWO TANKS

MULTILIFT (with single impeller pumps)	Inlet level [mm]	Number of tanks and volume [l]	Effective pump volume [l]	Power P1 / P2 [kW]	I1/I2 / Istart [A]	Number of poles	Voltage [V]	Starting method	Weight [kg]	Product number
MD1.80.100.15.4	700 / 840	2 x 450	480	2,1 / 1,5	3,9 / 26	4	3x380-415	D.O.L	340	97577870
MD1.80.100.22.4				2,9 / 2,2	5,3 / 38,3				340	97577872
MD1.80.100.30.4				3,7 / 3,0	7,2 / 50				428	97577874
MD1.80.100.40.4				4,9 / 4,0	9,7 / 51			463	97577876	
MD1.80.100.55.4				6,4 / 5,5	11,8 / 81			473	97577878	
MD1.80.100.75.4				8,6 / 7,5	15,2 / 109			604	97577880	

MULTILIFT MD1/MDV are available as a variant with an inlet DN200 instead of DN150. Please ask your local Grundfos representative.

MULTILIFT MDV

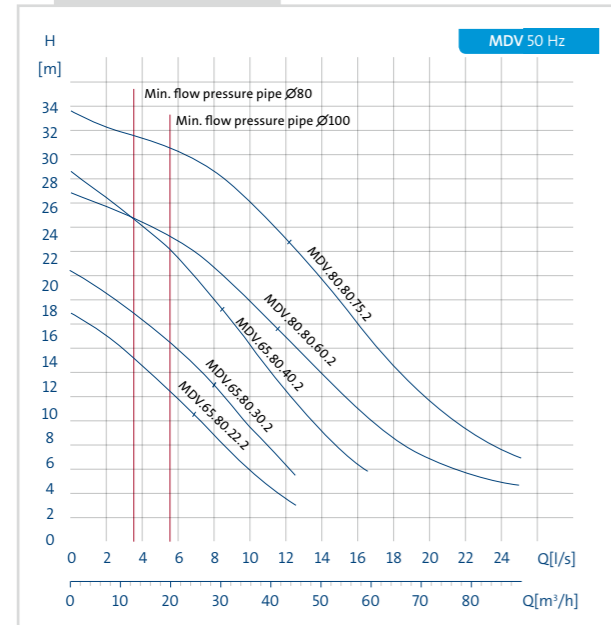

MULTILIFT MD1.80

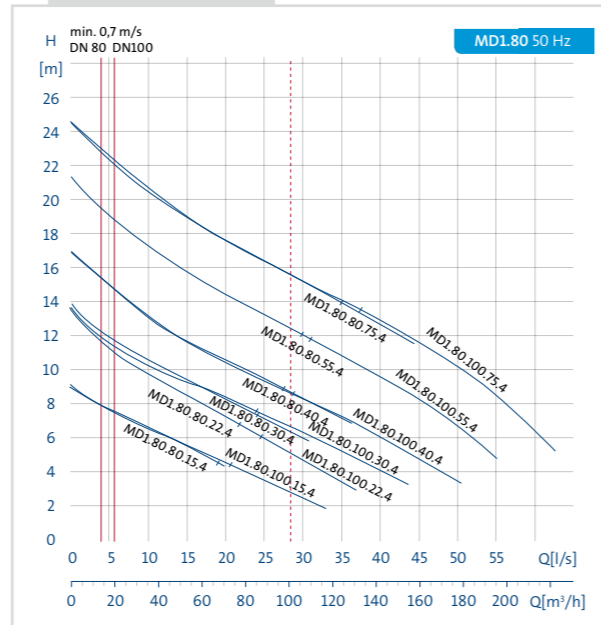

ISO 9906 Grade 2

TECHNICAL DATA MULTILIFT MDV – DOUBLE PUMP UNITS WITH ONE TANK

MULTILIFT (with vortex impeller pumps)	Inlet level [mm]	Number of tanks and volume [l]	Effective pump volume [l]	Power P1 / P2 [kW]	I1/I2 / Istart [A]	Number of poles	Voltage [V]	Starting method	Weight [kg]	Product number
MDV.65.80.22.2	700 / 840	1 x 450	240	2,8 / 2,2	4,9 / 43	2	3x380-415	D.O.L	280	97577818
MDV.65.80.30.2				3,8 / 3,0	6,8 / 59,8				280	97577833
MDV.65.80.40.2				4,8 / 4,0	8,5 / 93				320	97577836
MDV.80.80.60.2				6,9 / 6,0	12,5 / 122			335	97577838	
MDV.80.80.75.2				8,7 / 7,5	15,1 / 152			336	97577840	

TECHNICAL DATA MULTILIFT MD1 – DOUBLE PUMP UNITS WITH ONE TANK

MULTILIFT (with single impeller pumps)	Inlet level [mm]	Number of tanks and volume [l]	Effective pump volume [l]	Power P1 / P2 [kW]	I1/I2 / Istart [A]	Number of poles	Voltage [V]	Starting method	Weight [kg]	Product number
MD1.80.80.15.4	700 / 840	1 x 450	240	2,1 / 1,5	3,9 / 26	4	3x380-415	D.O.L	300	97577857
MD1.80.80.22.4				2,9 / 2,2	5,3 / 38,3				300	97577859
MD1.80.80.30.4				3,7 / 3,0	7,2 / 50				360	97577861
MD1.80.80.40.4				4,9 / 4,0	9,7 / 51			380	97577863	
MD1.80.80.55.4				6,4 / 5,5	11,8 / 81			390	97577865	
MD1.80.80.75.4				8,6 / 7,5	15,2 / 109			490	97577867	

MULTILIFT MD1/MDV – double pump units with one tank

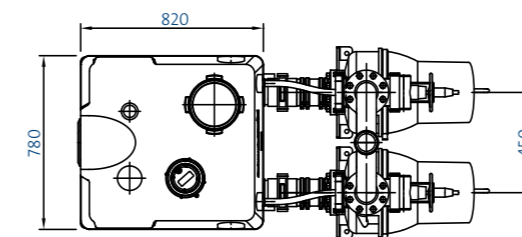

Installation possibilities:

1. Cast iron gate valve
2. PVC gate valve (accessory)

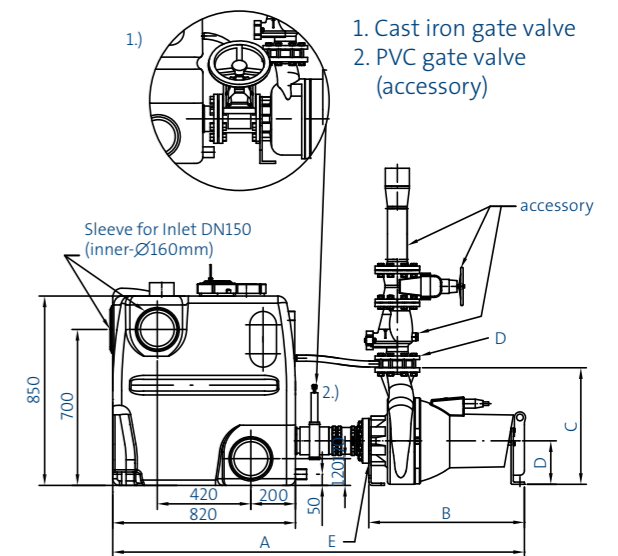

MULTILIFT MD1 – double pump units with two tanks

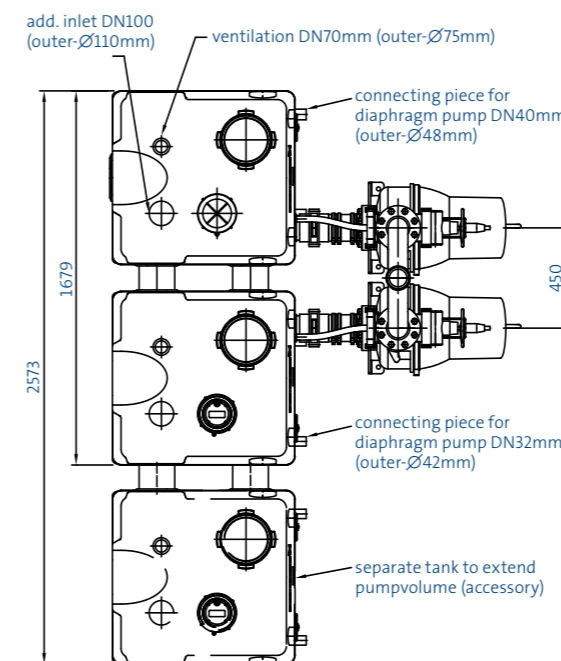

DIMENSIONS MD1/MDV

MULTILIFT	P1 [kW]	Dimensions [mm]					
		A ¹⁾	A ²⁾	B	C	D	E
MDV.65.80.22./30.2	2,8-3,8	1605	1685	535	447	DN80	
MDV.65.80.40.2	4,8	1690	1770	620	476		
MDV.80.80.60.-75.2	7,1-8,9	1695	1775	625	476		
MD1.80.80.15.-22.4	2,1-2,9	1625	1705	555	472	DN80	
MD1.80.80.30.-55.4	3,7-6,5	1655	1735	585	519		
MD1.80.80.75.4	9	1775	1850	705	528		
MD1.80.100.15.-22.4	2,1-2,9	1625	1705	555	472	DN100	
MD1.80.100.30.-55.4	3,7-6,5	1655	1735	585	519		
MD1.80.100.75.4	9	1775	1850	705	528		

¹⁾ Cast iron gate valve – ²⁾ PVC gate valve

Scope of delivery:

MULTILIFT MD1/MDV

Are delivered with one or two tanks, SE or SL pumps with horizontal installation kit, two socket sealings DN100 and flange with connection piece for pump connection, controller with a 10m cable, 10m hose to the ram pressure tube, flexible connection hose with 2 clamps DN40 for diaphragm pump connection, flexible connection hose with 2 clamps DN70 (venting) and inlet socket sealing DN150. MULTILIFT MD1.80.100 is delivered with two tanks and the connection pieces and seals in between the collecting tanks.

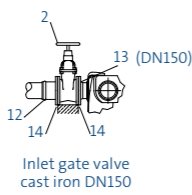
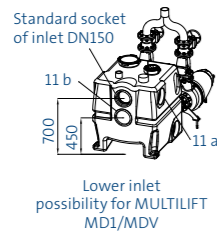
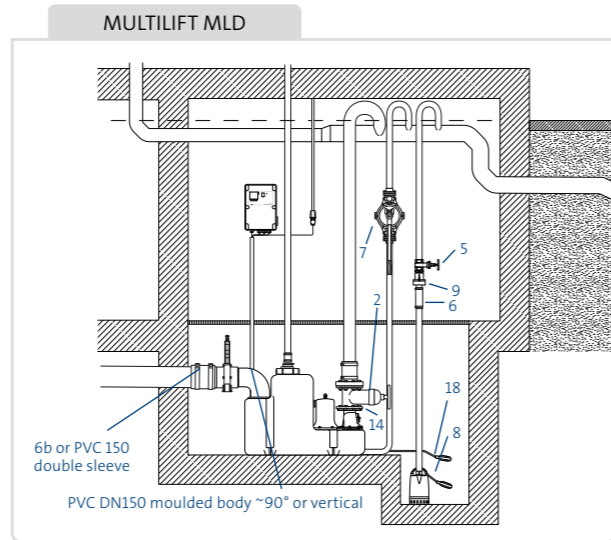
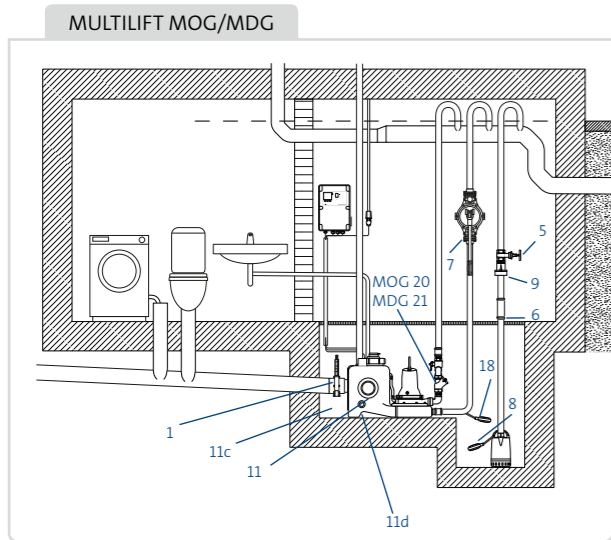
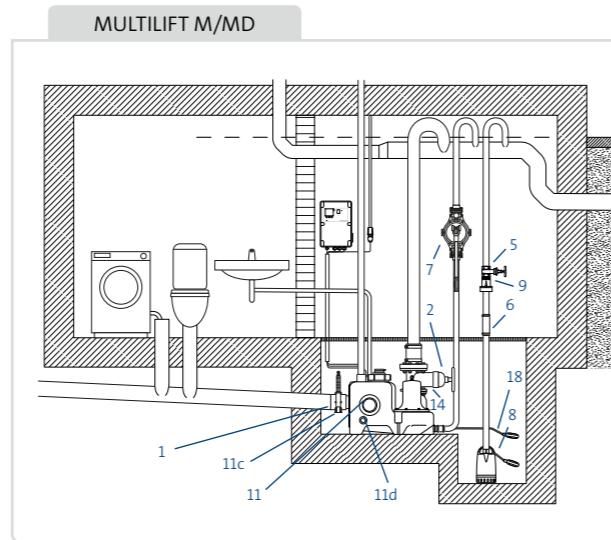
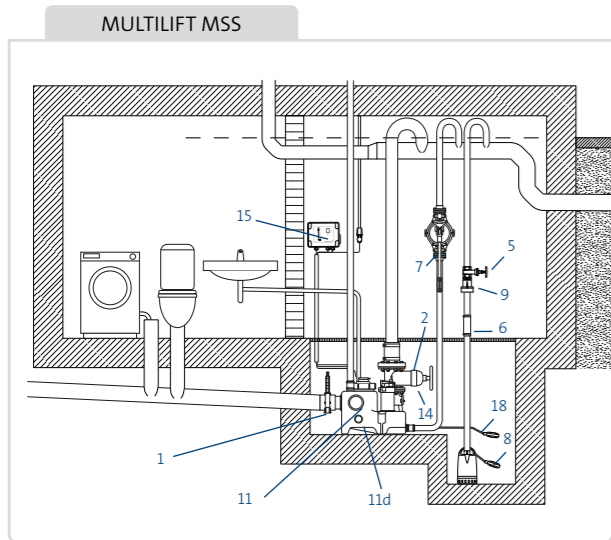

Lower inlet possibility for MULTILIFT MD1/MDV

Cast iron gate valves between collecting tank and SE/SL pumps at MULTILIFT MD1/MDV.



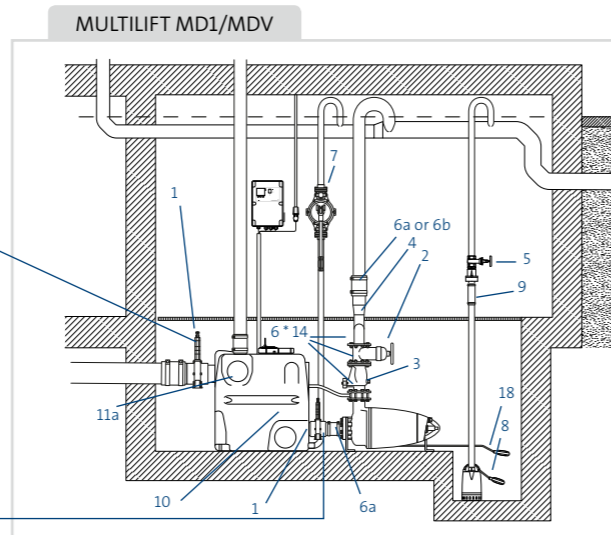

For size DN80 or DN100, see drawings on previous pages



PRODUCTS

No.	Picture	Description	Dimensions	Pump type							PN
				MSS	M	MOG	MD	MDG	MLD	MDV/MD1	
1		PVC gate valve DN100	Inst. length: 130mm Height: 375mm Conn. piece: Ø110mm	•	•	•	•	•	•	•	96615831
		PVC gate valve DN150	Inst. length: 227mm Height: 496mm Conn. piece: Ø160mm						•	•	96697920
2		Isolation valve DN80, cast iron, epoxy coated	Inst. length: 180mm Height: 300mm Connection: flange PN10	•	•		•		•	•	96002011
		Isolation valve DN100, cast iron, epoxy coated	Inst. length: 190mm Height: 340mm Conn.: flange PN10							•	96002012
		Isulating valve DN150, cast iron, epoxy coated	Inst. length: 210mm Height: 460mm Conn.: flange PN10							•	96003427
3		Non-return flap valve DN80, cast iron, epoxy coated	Inst. length: 260mm Conn.: flange PN10							•	96003826
		Non-return flap valve DN100, cast iron, epoxy coated	Inst. length: 300mm Conn.: flange PN10							•	96003827
4		Discharge pump flange / pipe end: DN80 / Ø90mm / H=359mm								•	96003704
		DN80 / Ø110mm / H=459mm								•	96003705
		DN100 / Ø110mm / H=410mm								•	96003706
		DN100 / Ø160mm / H=550mm								•	96003707
5		Gate valve DN32, brass	Length: 76mm, conn.: Rp 1 1/4"	•	•	•	•	•	•	•	00ID0918
6		DN 32 - length: 150mm, inner-Ø42mm		•	•	•	•	•	•	•	91071645
6a		DN100 - length: 150mm, inner-Ø110mm								•	96075422
6b		DN150 - length: 200mm, inner-Ø160mm								•	96473060

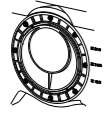
PRODUCTS

No.	Picture	Description	Dimensions	Pump type							PN
				MSS	M	MOG	MD	MDG	MLD	MDV/ MD1	
7		Manually operated diaphragm pump	Inst. length: 423mm, width: 215mm, conn.: Rp 1 1/2"	96003721
8		For wastewater pump, e.g. UNILIFT CC and KP, please have a look at the databooklet or WebCAPS.									
9		Non-return flap valve, composite	Length: 90mm, height: 90mm, conn.: Rp 1 1/4"	96005308
10		Extra PE-tank incl. connections, lids, sealings, and anchor bolts	Volume: 450 litre, dimensions s. drawing							.	96982790
11		Socket seal for additional standard inlet	DN100, inner-Ø110mm			97726942
11a		Socket seal for additional standard inlet	DN150, inner-Ø160mm		96636544
11b		Extra lip seal for lower inlet connection to the tank	DN150, inner-Ø160mm							.	91071939
		Hole-saw	Ø177mm							.	91713755
		Centre drill and arbor	Ø6mm							.	91712026
11c		Turnable inlet disk for replacement with socket seal	DN150/ inner-Ø160mm				98079681
11d		Socket seal for additional inlet	DN50/ inner-Ø48-50mm			98079669
12		Flange with socket (cast iron) for PVC pipe, incl. lip seal	DN150 / inner-Ø160mm							.	96003701
13		Kit flange hose unit (cast iron) with flex. connection and clamps	DN150 / outer-Ø160mm							.	96477895

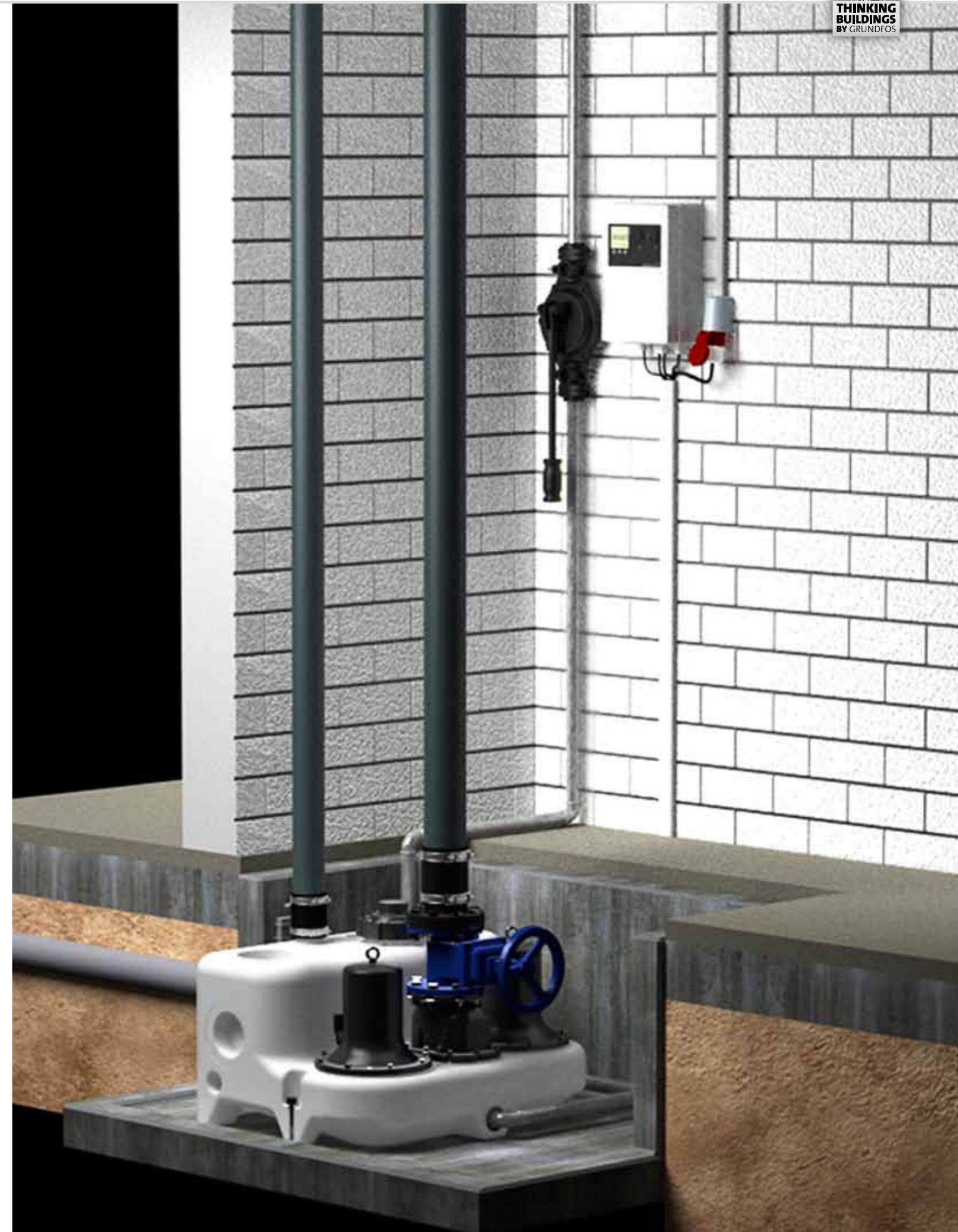

PRODUCTS

No.	Picture	Description	Dimensions	Pump type								PN
				MSS	M	MOG	MD	MLD	MDG	MDV/MDI		
14		Bolts, nuts, 8 of each 16x65mm (galvanised) and gasket	DN80	96001999	
			DN100	96003823		
			DN150	96003605		
15		Battery connector cable for LC 220/LC221 can be equipped with commercially available battery	9V	98079684	
16		Signal lamp to mount on a wall	1x230V, 50Hz	91077209	
17		Signal horn	Indoors, 1x230V, 50Hz	62500021	
			Outdoors, 1x230V, 50Hz	62500022	
18		Level switch type SAS	Cable length 5m, 250V	001D7805	
19		External main switch for supply cable	Up to 25 A	96002511	
			Up to 40 A	96002512	
20		1 1/2" complete pre-assembled pipework incl.: - 1 x flexible connecting piece with 2 clamps DN40 (not shown, see Pos. 6a) - 1 x hose nozzle Rp 1 1/2 / DN40 - 1 x ball valve R 1 1/2 - 2 x double nipple Rp 1 1/2 - 1 x non-return ball valve R 1 1/2 - 1 x bend 90° Rp 1 1/2 / R 1 1/2 (Pipework can be setup in 1 1/4" / DN32 locally)		98085356	
21		1 1/2" complete pre-assembled pipework incl.: - 1 x flexible connecting piece with 2 clamps DN32 (not shown, see Pos.6) - 1 x hose nozzle Rp 1 1/2 / DN40 - 1 x ball valve R 1 1/2 - 1 x cross piece Rp 1 1/2 - 1 x blind cover Rp 1 1/2 - 2 x long nipple R 1 1/2 - 2 x bend 90° Rp 1 1/2 / R 1 1/2 - 2 x double nipple R 1 1/2 - 2 x non-return ball valve R 1 1/2 - 2 x bend 90° Rp 1 1/2 / R 1 1/4 (Pipework can be setup in 1 1/4" / DN32 locally)		98085358	
22		Non-return ball valve Rp 1 1/4, length=140mm, width=83mm. Material: cast iron with epoxy coating to assemble on construction site		96116550	
		Non-return ball valve Rp 1 1/2, length=140mm, width=83mm. Material: cast iron with epoxy coating.		91076761	

THINKING BUILDINGS

At Grundfos CBS, we are always thinking buildings, and our products contribute to making buildings that can almost think for themselves. We do not just consider our products as stand-alone devices – we consider them an integral part of a living building whose purpose is to function in the best way possible for its inhabitants.

Our expertise is founded in decades of global experience and we are proud to share our knowledge with our clients. We are also determined to take the lead on new technologies and innovation opportunities.

Grundfos CBS offers products across the full range of applications, including heating, air conditioning, waste water, water disinfection, booster systems, fire protection systems and district energy.

To learn more about Grundfos CBS and to find out how we can be of assistance, contact Grundfos or visit us at www.thinkingbuildings.com

EXPLORE OUR ONLINE UNIVERSE

Make the most of Grundfos CBS – visit the Thinking Buildings Universe at www.thinkingbuildings.com

Our website contains a range of services that function as your online Grundfos CBS expert:

- Quick Pump Selection with an extensive product database and dimensioning tool that helps you choose the right pump for your needs
- E-learning programmes that let you improve your specialist knowledge
- Encyclopedia where you can find definitions of relevant professional terms
- White papers with in-depth discussions of specialist topics



Sign up for BLUEPRINT

Now you can have the latest news on pumps, technology and product launches sent straight to your inbox four times a year. Sign up for our online magazine BLUEPRINT on www.thinkingbuildings.com

Welcome to the Thinking Buildings Universe!



MULTILIFT lifting stations

The Grundfos MULTILIFT range comprises all-in-one systems designed to collect and lift wastewater from below sewer-level in buildings on any scale – from single-family houses to large commercial or industrial buildings.

The MULTILIFT range is part of Grundfos' comprehensive programme of pump solutions and environmental technology for buildings on any scale. We offer solutions for:

- Pressure boosting
- Heating
- Cooling
- Ground source energy
- District energy
- Water disinfection
- Wastewater handling
- Rainwater harvesting
- Fire fighting