

Flow sensors





Grundfos Direct Sensors™

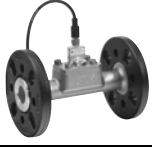
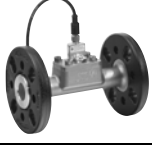

1. Product overview	3
2. Product introduction	4
Vortex principle	4
Construction	4
Material	4
Definitions	4
3. Vortex Flow sensor, Industry (VFI and VFI+T2)	5
General data	5
VFI and VFI+T2, 0.3 - 6 m ³ /h (1.3 - 26.4 gpm)	7
VFI and VFI+T2, 0.6 - 12 m ³ /h (2.6 - 52.8 gpm)	8
VFI and VFI+T2, 1.3 - 25 m ³ /h (5.7 - 110 gpm)	9
VFI and VFI+T2, 2-40 m ³ /h (8.8 - 176 gpm)	10
VFI and VFI+T2, 3.2 - 64 m ³ /h (14-282 gpm)	11
VFI and VFI+T2, 5.2 - 104 m ³ /h (23-458 gpm)	12
VFI and VFI+T2, 8-160 m ³ /h (35-704 gpm)	13
VFI and VFI+T2, 12-240 m ³ /h (53-1057 gpm)	14
4. Vortex Flow sensor, Standard (VFS and VFS QT)	15
VFS, 1-20 l/min (0.2 - 5.3 gpm)	17
VFS, 2-40 l/min (0.5 - 10.6 gpm)	18
VFS, 5-100 l/min (1.3 - 26 gpm)	19
VFS, 10-200 l/min (2.6 - 53 gpm)	20
VFS, 20-400 l/min (5.3 - 106 gpm)	21
VFS QT, 1-18 l/min (0.2 - 4.8 gpm)	22
VFS QT, 2-40 l/min (0.5 - 10.6 gpm)	23
VFS QT, 5-100 l/min (1.3 - 26 gpm)	24
VFS QT, 10-200 l/min (2.6 - 53 gpm)	25
5. Multi Flow sensor, standard (MFS and MFS QT)	26
General data	26
MFS 2-20 l/min (0.53 - 5.3 gpm)	28
MFS 4-40 l/min (1.06 - 10.6 gpm)	29
MFS 10-100 l/min (2.6 - 26 gpm)	30
MFS 20-200 l/min (5.3 - 53 gpm)	31
MFS 40-400 l/min (10.6 - 106 gpm)	32
MFS QT 2-18 l/min (0.39 - 4.8 gpm)	33
MFS QT 4-40 l/min (1 - 10.6 gpm)	34
MFS QT 10-100 l/min (2.6 - 26 gpm)	35
MFS QT 20-200 l/min (5.3 - 53 gpm)	36
6. Product range	37
VFI transmitters	37
VFS and VFS QT sensors	38
7. Accessories	39
Sensor interface, converter unit	39
M12 cable	39
Snap-on cable	39
8. Appendix	40
Pressure drop curves	40
Installation of the VFI sensor	42
Intended use for pressurised systems	43
9. Grundfos Product Center	44

1. Product overview

This data booklet is for the latest version of Grundfos Direct Sensors™. Customers already buying Grundfos Direct Sensors™ might be buying a sensor with another specification.

Variant	Description	Technical data
VFI 	Vortex flow sensor, industry <ul style="list-style-type: none"> all stainless steel Grundfos flanges or fittings. 	Flow range: 0.3 - 240 m ³ /h (1.3 - 1057 gpm) System pressure: Maximum 30 bar (435 psig) System temperature: -30 to +110 °C (-22 to +230 °F) Signal: 4-20 mA (2-wire) Power supply: 12.5 - 30 VDC Enclosure class: IP67
VFI+T 	Vortex flow sensor, industry <ul style="list-style-type: none"> combined flow and temperature measurement Grundfos flanges or fittings. 	Flow range: 0.3 - 240 m ³ /h (1.3 - 1057 gpm) Temperature range: 0-100 °C (32-212 °F) System pressure: Maximum 30 bar (435 psig) System temperature: -30 to +110 °C (-22 to +230 °F) Signal: 4-20 mA (2-wire) Power supply: 12.5 - 30 VDC Enclosure class: IP67
VFS 	Vortex flow sensor, standard <ul style="list-style-type: none"> combined flow and temperature measurement composite flow pipe. 	Flow range: 1.3 - 400 l/min (0.2 - 106 gpm) Temperature range: 0-120 °C (32-248 °F) System pressure: Maximum 24 bar (348 psig) System temperature: 0-100 °C (32-212 °F) Signal: 2 x 0.5 - 3.5 VDC (4-wire) Power supply: 5 VDC (PELV) Enclosure class: IP44
VFS QT 	Vortex flow sensor, standard QT <ul style="list-style-type: none"> combined flow and temperature measurement stainless-steel pipe with composite insert. 	Flow range: 1-200 l/min (0.2-53 gpm) Temperature range: 0-120 °C (32-248 °F) System pressure: Maximum 30 bar (435 psig) System temperature: 0-120 °C (32-248 °F) Signal: 2 x 0.5 - 3.5 VDC (4-wire) Power supply: 5 VDC (PELV) Enclosure class: IP44
MFS 	Multiflow sensor, standard <ul style="list-style-type: none"> combined flow, pressure and temperature measurement output: two analog signals or proprietary digital bus for three signals (flow, temperature and pressure) composite flow pipe. 	Flow range: 2.6 - 400 l/min (0.5 - 106 gpm) Temperature range: 0-120 °C (32-248 °F) Pressure range: 0-10 bar (0-145 psig) System pressure: Maximum 24 bar (348 psig) System temperature: 0-100 °C (32-212 °F) Signal: Digital or analog communication, 2 x 0.5 - 3.5 VDC (4-wire) Power supply: 5 VDC (PELV) Enclosure class: IP44
MFS QT 	Multiflow sensor, standard QT <ul style="list-style-type: none"> combined flow, pressure and temperature measurement output: two analog signals or proprietary digital bus for three signals (flow, temperature and pressure) stainless-steel pipe with composite insert. 	Flow range: 2-200 l/min (0.5 - 53 gpm) Temperature range: 0-120 °C (32-248 °F) Pressure range: 0-10 bar (0-145 psig) System pressure: Maximum 30 bar (435 psig) System temperature: 0-120 °C (32-248 °F) Signal: Digital or analog communication, 2 x 0.5 - 3.5 or 4.1 VDC (4-wire) Power supply: 5 VDC (PELV) Enclosure class: IP44

2. Product introduction

This data booklet gives an overview of the Grundfos vortex flow sensor range and related products.

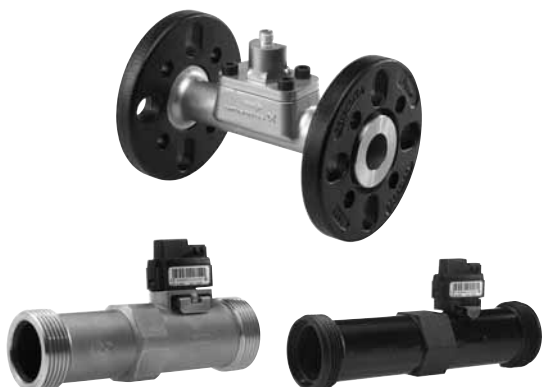

Fig. 1 Grundfos vortex flow sensors

The Grundfos vortex flow sensor range comprises flow measurement systems as well as combined flow and temperature measurement systems (two-in-one) designed for harsh aqueous environments.

Vortex principle

The flow measurement is based on the vortex principle. The system elements include a flow pipe with an integrated bluff body and a differential pressure sensor.

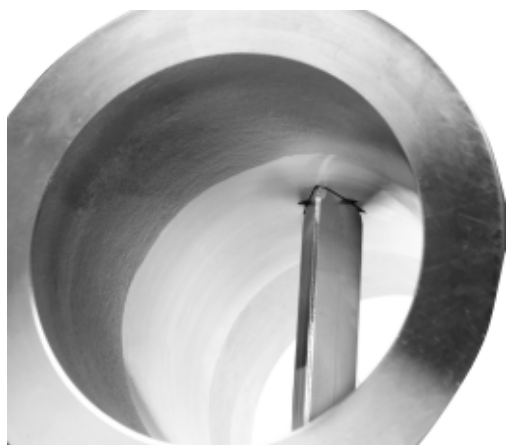

Fig. 2 Bluff body inside a vortex flow sensor

When a bluff body is placed inside a pipe, a series of vortices will be generated on either side of the bluff body. These vortices propagate downstream, giving rise to periodic pressure variations which can be detected by the pressure sensor. The frequency of the pressure variations is proportional to the volume flow through the pipe.

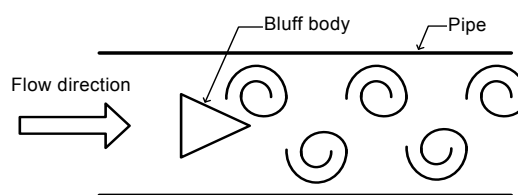

Fig. 3 Operating principle

The bluff body is designed to optimise the pulse strength of the pressure variations at the position of the differential pressure sensor.

Flow ranges are determined by the pipe diameter and the signal processing parameters. The differential pressure sensor key elements are a bulk micromachined silicon chip and a microprocessor-based signal-conditioning circuit, both on the same PCB. The conditioning circuit converts the pressure reading to a signal proportional to the flow.

Construction

The bluff body is either integrated in the composite flow pipe, or supplied as a separate composite or stainless steel part to be inserted in the flow pipe.

The square chip membrane warps due to the pressure difference. This is registered as a change of resistance in the strain gauges of a Wheatstone bridge. The pressure and temperature sensitive area, the membrane region, is coated on both sides by an extremely corrosion- and diffusion-resistant thin film (Silicoat®). The coating makes the chip environmentally robust. The liquid-free zone is sealed by an O-ring.

Material

The Grundfos vortex flow sensors are available in three material variants, suitable for different liquids:

- EPDM O-rings: Suitable for water; drinking-water approved.
- FKM O-rings: Suitable for oily liquids and water in heating applications.
- EPDM sealing cap with FKM O-rings: Suitable for water in heating applications with a high volume of calcium and magnetite.

Definitions

Burst Pressure

The maximum allowable pressure (relative to ambient) in a system, which will not destroy the sensor or transmitter. Measured in [bar].

Maximum System Pressure

Maximum allowable static pressure (relative to ambient pressure) in a system, where the flow is zero.

3. Vortex Flow sensor, Industry (VFI and VFI+T2)

General data



TM04 7362 2210

Fig. 4 VFI sensor

Technical overview

The VFI flow transmitter from Grundfos Direct Sensors™ is designed for industrial applications. The transmitter is based on the principle of vortex shedding behind a bluff body.

The VFI transmitter is fully compatible with wet, aggressive liquids. The transmitter is based on MEMS sensing technology in combination with the corrosion-resistant Silicoat® coating technology on the transmitter chip.

This makes the VFI transmitters very robust and ideal for pump integration and monitoring in harsh environments.

The transmitter is supplied with a stainless steel flow pipe, available with flanges or in a threaded version.

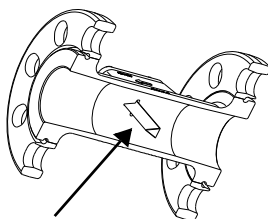

TM04 9228 3710

Fig. 5 Bluff body in a VFI transmitter

Applications

- Pump control
- HVAC systems
- temperature control and chiller systems
- renewable energies such as heat pumps, solar thermals, fresh water and micro-CHP systems
- monitoring and control systems
- water treatment plants
- water utility and distribution systems
- HPC (High-Performance Computing) and IT cooling systems.

Features and benefits

- Measurement principle with no movable parts, resulting in no wear and tear
- MEMS technology
- direct contact with the aqueous media resulting in a fast response time
- plug and play for quick setup
- smart system solution with Grundfos pump controls
- compact and robust design
- compatible with aqueous media
- suitable for a wide temperature range
- suitable for a wide range of application.
- For aqueous media below 2 μS/cm contact your local Grundfos sensor representative.

Flow range

m ³ /h	gpm
0.3 - 6	1.32 - 26.42
0.6 - 12	2.64 - 52.83
1.3 - 25	5.72 - 110.07
2-40	8.81 - 176.11
3.2 - 64	14.09 - 281.78
5.2 - 104	22.89 - 457.89
8-160	35.22 - 704.46
12-240	52.83 - 1056.69

Approvals (w/EPDM O-rings)

- WRAS
- KTW
- AS4020
- ACS.

Certificates

CE	C, CSA, US	EAC

Electrical connections

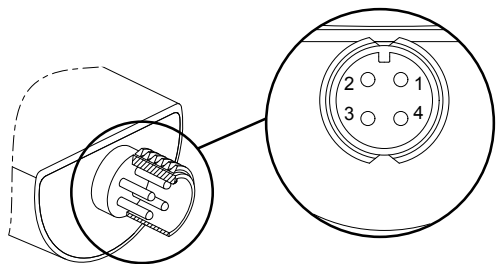

TM06 1070 1514

Fig. 6 Electrical connections

VFI Signal condition: 2-wire, loop-powered.

Pin	1	2	3	4
Wire colour	Brown	White	Blue	Black
I/O	Power supply	Not used	Flow signal 4-20 mA	Not used

Power supply: 12.5 - 30 V, screened cable.

VFI+T Signal condition: 4-wire

Pin	1	2	3	4
Wire colour	Brown	White	Blue	Black
I/O	Power supply	Flow signal 0-10 V	GND*	Temperature signal 0-10 V

* Common ground for pressure and temperature signals.
Power supply, screened cable: SELV or PELV.

Directives

The Grundfos Direct Sensors™ are in conformity with these council directives on the approximation of the laws of the EC member states:

- Low Voltage Directive (2014/35/EU)
 - Standards used: EN 61010-1:2010
- EMC Directive (2014/30/EU).
 - Standards used: EN 61326-1:2013 and EN 61326-2-3:2013

The Grundfos Direct Sensors™ are exempted from the Pressure Equipment Directive (PED) according to Article 4, paragraph 3 in the PED 2014/68/EU.

VFI and VFI+T2, 0.3 - 6 m³/h (1.3 - 26.4 gpm)

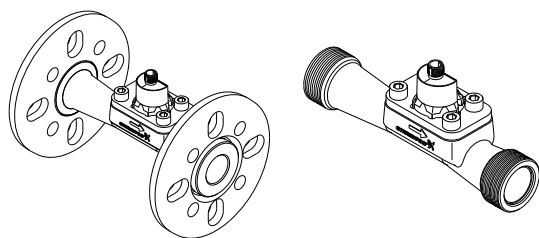

Fig. 7 VFI sensor with flanges and thread

TM04 7142 1710 - TM04 4250 1710

Dimensions

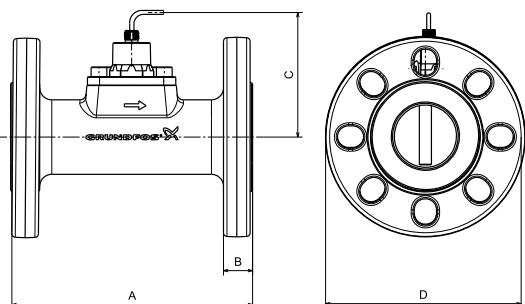

Fig. 8 Dimensions, VFI with flanges

TM04 7154 1610

	A	B	C	D	ISO/DIN flange, DN 18 pipe	
mm	200	18	120	140	DN 25/32	PN 25/40
in	7.87	0.71	4.72	5.51		

For flanges according to ANSI and JIS standards or for other pressure ranges, contact Grundfos Direct Sensors™.

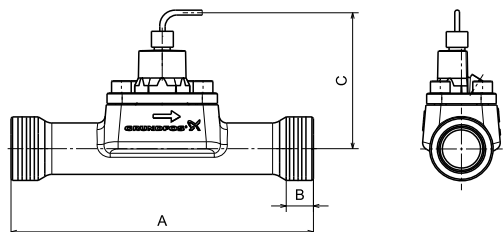

Fig. 9 Dimensions, VFI with thread

TM04 7153 1610

	A	B	C	Thread size
mm	200	18	120	G1 1/4"
in	7.87	0.71	4.72	

Sensor output signals

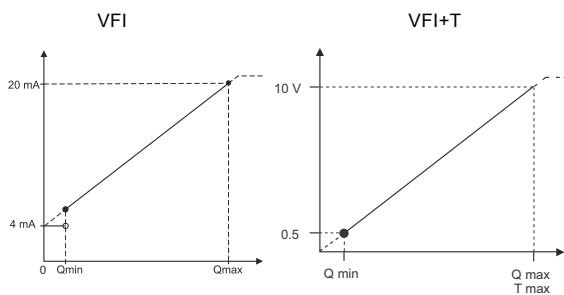

Fig. 10 Flow response

TM06 0951 1316 - TM07 2164 2918

Specifications

Flow	
Measuring range	0.3 - 6 m ³ /h (1.32 to 26.42 gpm)
Accuracy (± 1 σ) in water, 0-100 °C (32-212 °F)	± 1.5 % FS
Response time (63.2 %)	Less than 1 s
Resolution	0.0075 m ³ /h (0.03 gpm)
Temperature, VFI+T with temperature output	
Measuring range	-10 - 120 °C (14-248 °F)
Accuracy (± 1 σ), 15-90 °C (59-194 °F)	± 0.5 K
Accuracy (± 1 σ), -10 - 120 °C (14-248 °F)	± 1 K
Response time (63.2 % at 50 % FS flow)	250 ms
Resolution	0.1 K
System conditions and environment	
Liquid types	Aqueous media compatible with wetted materials. Kinematic viscosity less than or equal to 6 mm ² /s (cSt). See appendix <i>Pressure drop curves</i>
Maximum system pressure	30 bar (435 psig)
Burst pressure	40 bar (580 psig)
Liquid temperature, operation	-30 to +110 °C (-22 to +230 °F), non-freezing
Liquid temperature, peak	-30 to +110 °C (-22 to +230 °F), non-freezing
Ambient temperature, operation	-25 to +60 °C (-13 to +140 °F)
Ambient temperature, peak	-55 to +70 °C (-67 to +158 °F)
Storage temperature	-55 to +70 °C (-67 to +158 °F)
Humidity, relative	0-95 %, non-condensing
Electrical data, VFI without temperature output	
Power supply, VFI	12.5 - 30 VDC
Output signals	4-20 mA
- Signal cut off	21 mA
Maximum power consumption	660 mW
Maximum load impedance	60 Ω at 12.5 VDC 100 Ω at 13.3 VDC 600 Ω at 24 VDC 900 Ω at 30 VDC
Maximum cable length	30 m (98 ft)
Electrical data, VFI+T with temperature output	
Power supply	16.6 - 30 VDC
Output signals	0-10 VDC
- Signal cut off	(-10 °C at 0 V, 120 °C at 10 V) 11 VDC
Maximum power consumption	270 mW
Maximum load impedance	10 kΩ
Maximum cable length	30 m (98 ft)
Materials	
Sensing element	Silicon-based MEMS
O-ring	EPDM or FKM
Housing	Stainless steel 1.4404 (AISI 316 L)
Flow pipe	Stainless steel 1.4408 (AISI 316)
Flange, no liquid contact	Cast iron or stainless steel
Bluff body	Stainless steel 1.4401 (AISI 316 L)
Wetted materials	Corrosion-resistant coating, EPDM or FKM, Stainless steel 1.4401/04/08 (AISI 316 L)
Environmental standards	
Enclosure class	IP67, cable connected
Temperature cycling	IEC 68-2-14
Vibration, non-destructive	20-2000 Hz, 10G, 4 h
Electromagnetic compatibility	EN 61326-1
Complete weight	
with cast iron flanges, cable etc	6.4 kg (14.1 lbs)
with stainless steel flanges, cable etc	5.2 kg (12.1 lbs)
with thread, unions, fittings, cable etc	3.4 kg (7.5 lbs)

Install the VFI sensor with threaded ends by means of union nuts with threaded ends by means of union nuts.

VFI and VFI+T2, 0.6 - 12 m³/h (2.6 - 52.8 gpm)

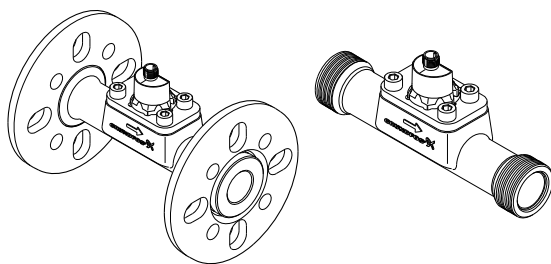

TM04 7143 1710 - TM04 4251 1710

Dimensions

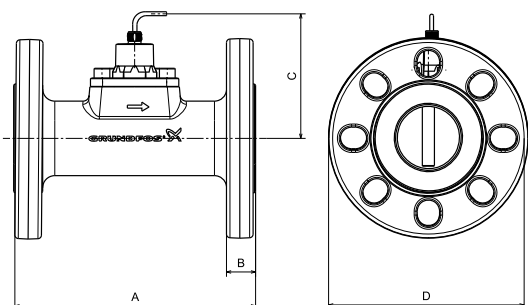

TM04 7154 1610

Fig. 11 Dimensions, VFI with flanges

	A	B	C	D	ISO/DIN flange, DN 25 pipe	
mm	200	18	124	140	DN 25/32	PN 16/25/40
in	7.87	0.71	4.88	5.51		

For flanges according to ANSI and JIS standards or for other pressure ranges, contact Grundfos Direct Sensors™.

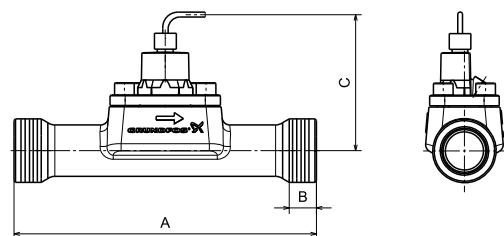

TM04 7153 1610

Fig. 12 Dimensions, VFI with thread

	A	B	C	Thread size
mm	200	18	124	G1 1/4"
in	7.87	0.71	4.88	

Sensor output signals

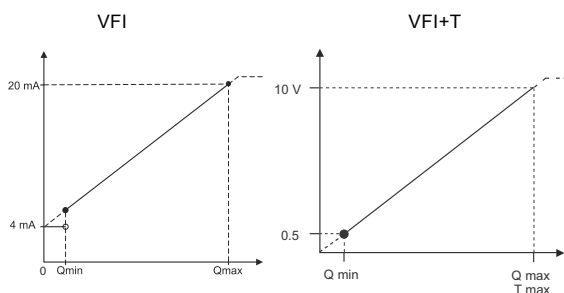

TM06 0951 1316 - TM07 2164 2918

Fig. 13 Flow response

Specifications

Flow	
Measuring range	0.6 - 12 m ³ /h (2.64 to 52.83 gpm)
Accuracy (± 1 σ) in water, 0-100 °C (32-212 °F)	± 1.5 % FS
Response time (63.2 %)	Less than 1 s
Resolution	0.015 m ³ /h (0.07 gpm)
Temperature, VFI+T with temperature output	
Measuring range	-10 - 120 °C (14-248 °F)
Accuracy (± 1 σ), 15-90 °C (59-194 °F)	± 0.5 K
Accuracy (± 1 σ), -10 - 120 °C (14-248 °F)	± 1 K
Response time (63.2 % at 50 % FS flow)	250 ms
Resolution	0.1 K
System conditions and environment	
Liquid types	Aqueous media compatible with wetted materials. Kinematic viscosity less than or equal to 6 mm ² /s (cSt). See appendix <i>Pressure drop curves</i>
Max. system pressure	30 bar (435 psig)
Burst pressure	40 bar (580 psig)
Liquid temperature, operation	-30 to +110 °C (-22 to +230 °F), non-freezing
Liquid temperature, peak	-30 to +110 °C (-22 to +230 °F), non-freezing
Ambient temperature, operation	-25 to +60 °C (-13 to +140 °F)
Ambient temperature, peak	-55 to +70 °C (-67 to +158 °F)
Storage temperature	-55 to +70 °C (-67 to +158 °F)
Humidity, relative	0-95 %, non-condensing
Electrical data, VFI without temperature output	
Power supply	12.5 - 30 VDC (± 5 %)
Output signals	4-20 mA
– Signal cut off	21 mA
Maximum power consumption	660 mW
	60 Ω at 12.5 VDC
	100 Ω at 13.3 VDC
Maximum load impedance	600 Ω at 24 VDC
	900 Ω at 30 VDC
Maximum cable length	30 m (98 ft)
Electrical data, VFI+T with temperature output	
Power supply, VFI	16.6 - 30 VDC
Output signals	0-10 VDC
	(-10 °C at 0 V, 120 °C at 10 V)
– Signal cut off	11 VDC
Maximum power consumption	270 mW
Maximum load impedance	10 kΩ
Maximum cable length	30 m (98 ft)
Materials	
Sensing element	Silicon-based MEMS
O-ring	EPDM or FKM
Housing	Stainless steel 1.4404 (AISI 316 L)
Flow pipe	Stainless steel 1.4408 (AISI 316)
Flange, no liquid contact	Cast iron or stainless steel
Bluff body	Stainless steel 1.4401 (AISI 316 L)
Wetted materials	Corrosion-resistant coating, EPDM or FKM, Stainless steel 1.4401/04/08 (AISI 316 L)
Environmental standards	
Enclosure class	IP67, cable connected
Temperature cycling	IEC 68-2-14
Vibration, non-destructive	20-2000 Hz, 10G, 4 h
Electromagnetic compatibility	EN 61326-1
Complete weight	
with cast iron flanges, cable etc	6.5 kg (14.3 lbs)
with stainless steel flanges, cable etc	5.6 kg (12.3 lbs)
with thread, unions, fittings, cable etc	3.6 kg (7.9 lbs)

Install the VFI sensor with threaded ends by means of union nuts.

VFI and VFI+T2, 1.3 - 25 m³/h (5.7 - 110 gpm)

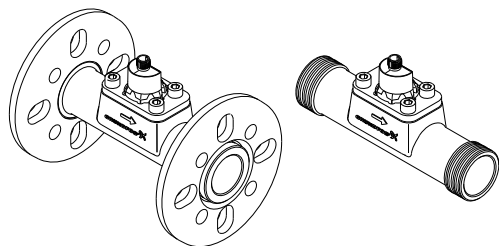

TM04 7144 1710 - TM04 4252 1710

Dimensions

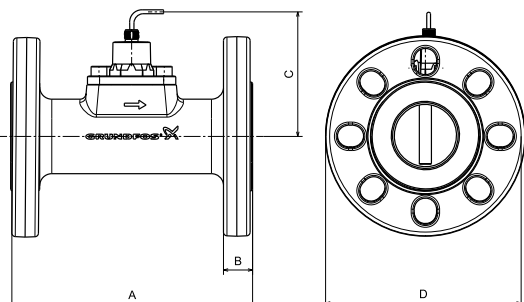

TM04 7154 1610

Fig. 14 Dimensions, VFI with flanges

	A	B	C	D	ISO/DIN flange, DN 32 pipe	
mm	200	18	128	140	DN 25/32	PN 16/25/40
in	7.87	0.71	5.04	5.51		

For flanges according to ANSI and JIS standards or for other pressure ranges, contact Grundfos Direct Sensors™.

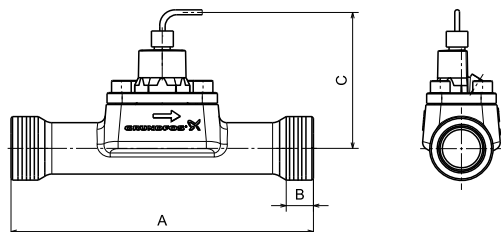

TM04 7153 1610

Fig. 15 Dimensions, VFI with thread

	A	B	C	Thread size
mm	200	19	128	G1 1/2"
in	7.87	0.75	5.04	

Sensor output signals

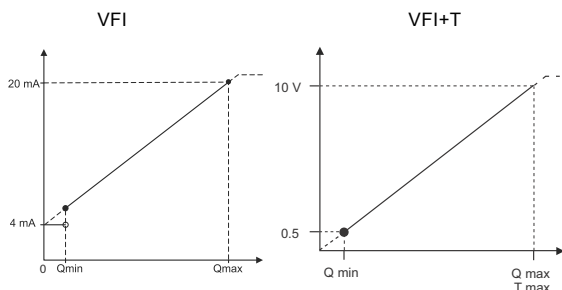

TM06 0951 1316 - TM07 2164 2918

Fig. 16 Flow response

Specifications

Flow	
Measuring range	1.3 - 25 m ³ /h (5.72 to 110.07 gpm)
Accuracy (± 1 σ) in water, 0-100 °C (32-212 °F)	± 1.5 % FS
Response time	Less than 1 s
Resolution	0.031 m ³ /h (0.14 gpm)
Temperature, VFI+T with temperature output	
Measuring range	-10 - 120 °C (14-248 °F)
Accuracy (± 1 σ), 15-90 °C (59-194 °F)	± 0.5 K
Accuracy (± 1 σ), -10 - 120 °C (14-248 °F)	± 1 K
Response time (63.2 % at 50 % FS flow)	250 ms
Resolution	0.1 K
System conditions and environment	
Liquid types	Aqueous media compatible with wetted materials. Kinematic viscosity less than or equal to 6 mm ² /s (cSt). See appendix <i>Pressure drop curves</i>
Max. system pressure	30 bar (435 psig)
Burst pressure	40 bar (580 psig)
Liquid temperature, operation	-30 to +110 °C (-22 to +230 °F), non-freezing
Liquid temperature, peak	-30 to +110 °C (-22 to +230 °F), non-freezing
Ambient temperature, operation	-25 to +60 °C (-13 to +140 °F)
Ambient temperature, peak	-55 to +70 °C (-67 to +158 °F)
Storage temperature	-55 to +70 °C (-67 to +158 °F)
Humidity, relative	0-95 %, non-condensing
Electrical data, VFI without temperature output	
Power supply, VFI	12.5 - 30 VDC
Output signals	4-20 mA
- Signal cut off	21 mA
Maximum power consumption	660 mW
	60 Ω at 12.5 VDC
	100 Ω at 13.3 VDC
Maximum load impedance	600 Ω at 24 VDC
	900 Ω at 30 VDC
Maximum cable length	30 m (98 ft)
Electrical data, VFI+T with temperature output	
Power supply, VFI	16.6 - 30 VDC
Output signals	0-10 VDC
	(-10 °C at 0 V, 120 °C at 10 V)
- Signal cut off	11 VDC
Maximum power consumption	270 mW
Maximum load impedance	10 kΩ
Maximum cable length	30 m (98 ft)
Materials	
Sensing element	Silicon-based MEMS
O-ring	EPDM or FKM
housing	Stainless steel 1.4404 (AISI 316 L)
Flow pipe	Stainless steel 1.4408 (AISI 316)
Flange, no liquid contact	Cast iron or stainless steel
Bluff body	Stainless steel 1.4401 (AISI 316 L)
Wetted materials	Corrosion-resistant coating, EPDM or FKM, Stainless steel 1.4401/04/08 (AISI 316 L)
Environmental standards	
Enclosure class	IP67, cable connected
Temperature cycling	IEC 68-2-14
Vibration, non-destructive	20-2000 Hz, 10G, 4 h
Electromagnetic compatibility	EN 61326-1
Complete weight	
with cast iron flanges, cable etc	6.5 kg (14.3 lbs)
with stainless steel flanges, cable etc	5.6 kg (12.3 lbs)
with thread, unions, fittings, cable etc	3.9 kg (8.6 lbs)

Install the VFI sensor with threaded ends by means of union nuts.

VFI and VFI+T2, 2-40 m³/h (8.8 - 176 gpm)

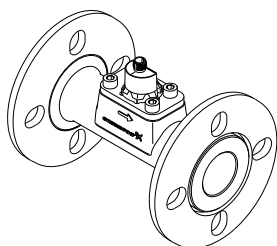
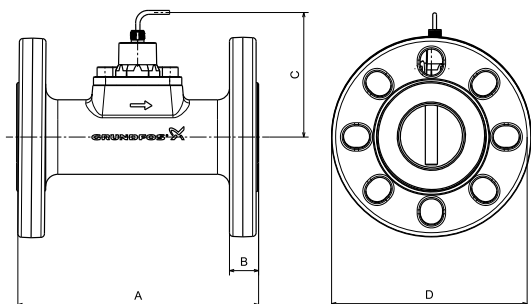

Fig. 17 VFI 2-40 sensor

TM04 7145 1710

Dimensions



TM04 7154 1610

Fig. 18 Dimensions, VFI with flanges

	A	B	C	D	ISO/DIN flange	
mm	200	18	131	150	DN 40	PN 16/25/40
in	7.87	0.71	5.16	5.91		

For flanges according to ANSI and JIS standards or for other pressure ranges, contact Grundfos Direct Sensors™.

Sensor output signals

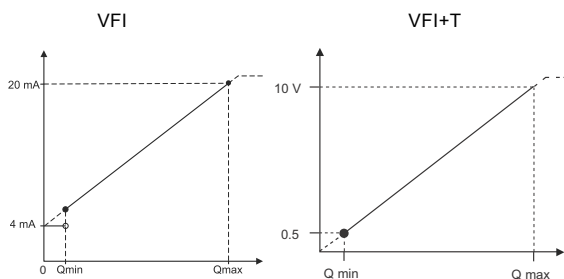

TM06 0951 1316 - TM07 2164 2918

Fig. 19 Flow response

Specifications

Flow	
Measuring range	2-40 m ³ /h (8.81 to 176.11 gpm)
Accuracy ($\pm 1 \sigma$) in water, 0-100 °C (32-212 °F)	± 1.5 % FS
Response time	Less than 1 s
Resolution	0.05 m ³ /h (0.22 gpm)
Temperature, VFI+T with temperature output	
Measuring range	-10 - 120 °C (14-248 °F)
Accuracy ($\pm 1 \sigma$), 15-90 °C (59-194 °F)	± 0.5 K
Accuracy ($\pm 1 \sigma$), -10 - 120 °C (14-248 °F)	± 1 K
Response time (63.2 % at 50 % FS flow)	250 ms
Resolution	0.1 K
System conditions and environment	
Liquid types	Aqueous media compatible with wetted materials. Kinematic viscosity less than or equal to 6 mm ² /s (cSt). See appendix <i>Pressure drop curves</i>
Maximum system pressure	30 bar (435 psig)
Burst pressure	40 bar (580 psig)
Liquid temperature, operation	-30 to +110 °C (-22 to +230 °F), non-freezing
Liquid temperature, peak	-30 to +110 °C (-22 to +230 °F), non-freezing
Ambient temperature, operation	-25 to +60 °C (-13 to +140 °F)
Ambient temperature, peak	-55 to +70 °C (-67 to +158 °F)
Storage temperature	-55 to +70 °C (-67 to +158 °F)
Humidity, relative	0-95 %, non-condensing
Electrical data, VFI without temperature output	
Power supply	12.5 - 30 VDC (± 5 %)
Output signals	4-20 mA
- Signal cut off	21 mA
Maximum power consumption	660 mW
Maximum load impedance	60 Ω at 12.5 VDC 100 Ω at 13.3 VDC 600 Ω at 24 VDC 900 Ω at 30 VDC
Maximum cable length	30 m (98 ft)
Electrical data, VFI+T with temperature output	
Power supply, VFI	16.6 - 30 VDC
Output signals	0-10 VDC
- Signal cut off	(-10 °C at 0 V, 120 °C at 10 V) 11 VDC
Maximum power consumption	270 mW
Maximum load impedance	10 k Ω
Maximum cable length	30 m (98 ft)
Materials	
Sensing element	Silicon-based MEMS
O-ring	EPDM or FKM
Housing	Stainless steel 1.4404 (AISI 316 L)
Flow pipe	Stainless steel 1.4408 (AISI 316)
Flange, no liquid contact	Cast iron or stainless steel
Bluff body	Stainless steel 1.4401 (AISI 316 L)
Wetted materials	Corrosion-resistant coating, EPDM or FKM, Stainless steel 1.4401/04/08 (AISI 316 L)
Environmental standards	
Enclosure class	IP67, cable connected
Temperature cycling	IEC 68-2-14
Vibration, non-destructive	20-2000 Hz, 10G, 4 h
Electromagnetic compatibility	EN 61326-1
Complete weight	
With cast iron flanges, cable etc	7.4 kg (16.3 lbs)
With stainless steel flanges, cable etc	6.5 kg (14.3 lbs)

VFI and VFI+T2, 3.2 - 64 m³/h (14-282 gpm)

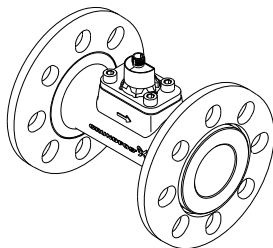

Fig. 20 VFI sensor

Dimensions

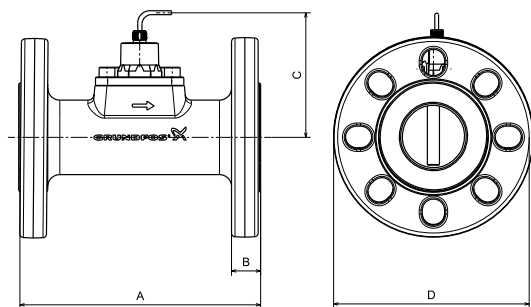

Fig. 21 Dimensions, VFI with flanges

	A	B	C	D	ISO/DIN flange	
mm	200	22	138	165	DN 50	PN16/25/40
in	7.87	0.87	5.43	6.50		

For flanges according to ANSI and JIS standards or for other pressure ranges, contact Grundfos Direct Sensors™.

Sensor output signals

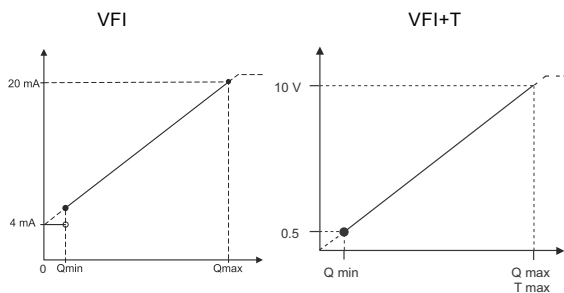

Fig. 22 Flow response

Specifications

Flow	
Measuring range	3.2 - 64 m ³ /h (14.09 to 281.78 gpm)
Accuracy (± 1 σ) in water, 0-100 °C (32-212 °F)	± 1.5 % FS
Response time (63.2 %)	Less than 1 s
Resolution	0.08 m ³ /h (0.35 gpm)
Temperature, VFI+T with temperature output	
Measuring range	-10 - 120 °C (14-248 °F)
Accuracy (± 1 σ), 15-90 °C (59-194 °F)	± 0.5 K
Accuracy (± 1 σ), -10 - 120 °C (14-248 °F)	± 1 K
Response time (63.2 % at 50 % FS flow)	250 ms
Resolution	0.1 K
System conditions and environment	
Liquid types	Aqueous media compatible with wetted materials. Kinematic viscosity less than or equal to 6 mm ² /s (cSt). See appendix <i>Pressure drop curves</i>
Maximum system pressure	30 bar (435 psig)
Burst pressure	40 bar (580 psig)
Liquid temperature, operation	-30 to +110 °C (-22 to +230 °F), non-freezing
Liquid temperature, peak	-30 to +110 °C (-22 to +230 °F), non-freezing
Ambient temperature, operation	-25 to +60 °C (-13 to +140 °F)
Ambient temperature, peak	-55 to +70 °C (-67 to +158 °F)
Storage temperature	-55 to +70 °C (-67 to +158 °F)
Humidity, relative	0-95 %, non-condensing
Electrical data, VFI without temperature output	
Power supply	12.5 - 30 VDC
Output signals	4-20 mA
– Signal cut off	21 mA
Maximum power consumption	660 mW
Maximum load impedance	60 Ω at 12.5 VDC 100 Ω at 13.3 VDC 600 Ω at 24 VDC 900 Ω at 30 VDC
Maximum cable length	30 m (98 ft)
Electrical data, VFI+T with temperature output	
Power supply	16.6 - 30 VDC
Output signals	0-10 VDC
– Signal cut off	(-10 °C at 0 V, 120 °C at 10 V) 11 VDC
Maximum power consumption	270 mW
Maximum load impedance	10 kΩ
Maximum cable length	30 m (98 ft)
Materials	
Sensing element	Silicon-based MEMS
O-ring	EPDM or FKM
Housing	Stainless steel 1.4404 (AISI 316 L)
Flow pipe	Stainless steel 1.4408 (AISI 316)
Flange, no liquid contact	Cast iron or stainless steel
Bluff body	Stainless steel 1.4401 (AISI 316 L)
Wetted materials	Corrosion-resistant coating, EPDM or FKM, Stainless steel 1.4401/04/08 (AISI 316 L)
Environmental standards	
Enclosure class	IP67, cable connected
Temperature cycling	IEC 68-2-14
Vibration, non-destructive	20-2000 Hz, 10G, 4 h
Electromagnetic compatibility	EN 61326-1
Complete weight	
With cast iron flanges, cable etc	9.4 kg (20.7 lbs)
With stainless steel flanges, cable etc	8.2 kg (18.0 lbs)

VFI and VFI+T2, 5.2 - 104 m³/h (23-458 gpm)

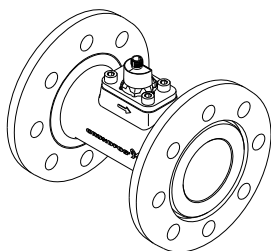

Fig. 23 VFI sensor

Dimensions

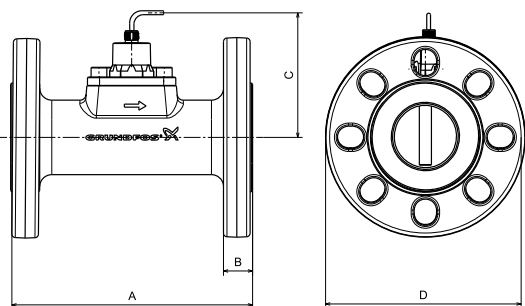

Fig. 24 Dimensions, VFI with flanges

	A	B	C	D	ISO/DIN flange	
mm	200	25	145	185	DN 65	PN 16/25/40
in	7.87	0.98	5.71	7.28		

For flanges according to ANSI and JIS standards or for other pressure ranges, contact Grundfos Direct Sensors™.

Sensor output signals

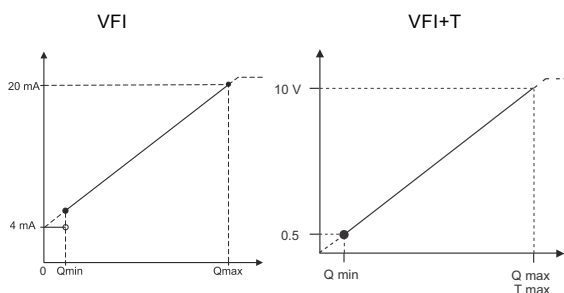

Fig. 25 Flow response

Specifications

Flow	
Measuring range	5.2 - 104 m ³ /h (22.89 - 457.89 gpm)
Accuracy (± 1 σ), 0-100 °C (32-212 °F)	± 1.5 % FS
Response time	Less than 1 s
Resolution	0.13 m ³ /h (0.57 gpm)
Temperature, VFI+T with temperature output	
Measuring range	-10 - 120 °C (14-248 °F)
Accuracy (± 1 σ), 15-90 °C (59-194 °F)	± 0.5 K
Accuracy (± 1 σ), -10 - 120 °C (14-248 °F)	± 1 K
Response time (63.2 % at 50 % FS flow)	250 ms
Resolution	0.1 K
System conditions and environment	
Liquid types	Aqueous media compatible with wetted materials. Kinematic viscosity less than or equal to 6 mm ² /s (cSt). See appendix <i>Pressure drop curves</i>
Maximum system pressure	30 bar (435 psig)
Burst pressure	40 bar (580 psig)
Liquid temperature, operation	-30 to +110 °C (-22 to +230 °F), non-freezing
Liquid temperature, peak	-30 to +110 °C (-22 to +230 °F), non-freezing
Ambient temperature, operation	-25 to +60 °C (-13 to +140 °F)
Ambient temperature, peak	-55 to +70 °C (-67 to +158 °F)
Storage temperature	-55 to +70 °C (-67 to +158 °F)
Humidity, relative	0-95 %, non-condensing
Electrical data, VFI without temperature output	
Power supply, VFI	12.5 - 30 VDC (± 5 %)
Output signals	4-20 mA
– Signal cut off	21 mA
Maximum power consumption	660 mW
Maximum load impedance	60 Ω at 12.5 VDC 100 Ω at 13.3 VDC 600 Ω at 24 VDC 900 Ω at 30 VDC
Maximum cable length	30 m (98 ft)
Electrical data, VFI+T with temperature output	
Power supply, VFI	16.6 - 30 VDC
Output signals	0-10 VDC
– Signal cut off	(-10 °C at 0 V, 120 °C at 10 V) 11 VDC
Maximum power consumption	270 mW
Maximum load impedance	10 kΩ
Maximum cable length	30 m (98 ft)
Materials	
Sensing element	Silicon-based MEMS
O-ring	EPDM or FKM
Housing	Stainless steel 1.4404 (AISI 316 L)
Flow pipe	Stainless steel 1.4408 (AISI 316)
Flange, no liquid contact	Cast iron or stainless steel
Bluff body	Stainless steel 1.4401 (AISI 316 L)
Wetted materials	Corrosion-resistant coating, PDM or FKM, stainless steel 1.4401/04/08 (AISI 316 L)
Environmental standards	
Enclosure class	IP67, cable connected
Temperature cycling	IEC 68-2-14
Vibration, non-destructive	20-2000 Hz, 10G, 4 h
Electromagnetic compatibility	EN 61326-1
Complete weight	
With cast iron flanges, cable etc	11.5 kg (25.3 lbs)
With stainless steel flanges, cable etc	11.9 kg (26.2 lbs)

Vortex flow sensors

VFI and VFI+T2, 8-160 m³/h (35-704 gpm)

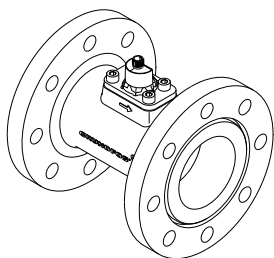

Fig. 26 VFI sensor

Dimensions

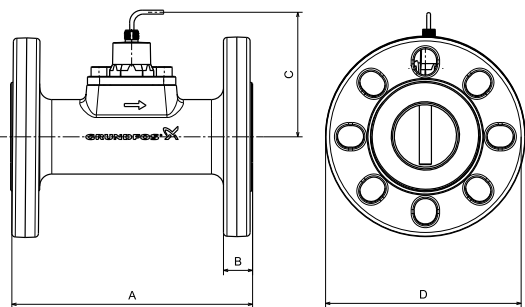

Fig. 27 Dimensions, VFI with flanges

	A	B	C	D	ISO/DIN flange	
mm	200	25	152	200	DN 80	PN 16/25/40
in	7.87	0.98	5.98	7.87		

For flanges according to ANSI and JIS standards or for other pressure ranges, contact Grundfos Direct Sensors™.

Sensor output signals

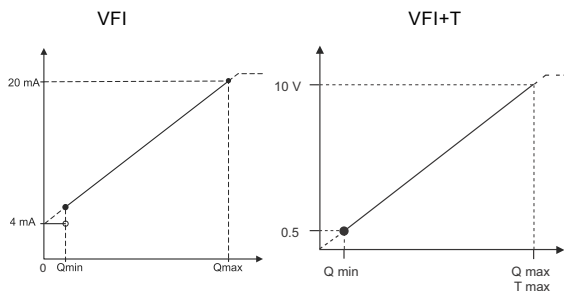

Fig. 28 Flow response

Specifications

Flow	
Measuring range	8-160 m ³ /h (35.22 to 704.46 gpm)
Accuracy ($\pm 1 \sigma$), 0-100 °C (32-212 °F)	$\pm 1.5\%$ FS
Response time	Less than 1 s
Resolution	0.2 m ³ /h (0.88 gpm)
Temperature, VFI+T with temperature output	
Measuring range	-10 - 120 °C (14-248 °F)
Accuracy ($\pm 1 \sigma$), 15-90 °C (59-194 °F)	± 0.5 K
Accuracy ($\pm 1 \sigma$), -10 - 120 °C (14-248 °F)	± 1 K
Response time (63.2 % at 50 % FS flow)	250 ms
Resolution	0.1 K
System conditions and environment	
Liquid types	Aqueous media compatible with wetted materials. Kinematic viscosity less than or equal to 6 mm ² /s (cSt). See appendix <i>Pressure drop curves</i>
Maximum system pressure	30 bar (435 psig)
Burst pressure	40 bar (580 psig)
Liquid temperature, operation	-30 to +110 °C (-22 to +230 °F), non-freezing
Liquid temperature, peak	-30 to +110 °C (-22 to +230 °F), non-freezing
Ambient temperature, operation	-25 to +60 °C (-13 to +140 °F)
Ambient temperature, peak	-55 to +70 °C (-67 to +158 °F)
Storage temperature	-55 to +70 °C (-67 to +158 °F)
Humidity, relative	0-95 %, non-condensing
Electrical data, VFI without temperature output	
Power supply	12.5 - 30 VDC ($\pm 5\%$)
Output signals	4-20 mA
- Signal cut off	21 mA
Maximum power consumption	660 mW
Maximum load impedance	60 Ω at 12.5 VDC 100 Ω at 13.3 VDC 600 Ω at 24 VDC 900 Ω at 30 VDC
Maximum cable length	30 m (98 ft)
Electrical data, VFI+T with temperature output	
Power supply	16.6 - 30 VDC
Output signals	0-10 VDC
- Signal cut off	(-10 °C at 0 V, 120 °C at 10 V) 11 VDC
Maximum power consumption	270 mW
Maximum load impedance	10 k Ω
Maximum cable length	30 m (98 ft)
Materials	
Sensing element	Silicon-based MEMS
O-ring	EPDM or FKM
Housing	Stainless steel 1.4404 (AISI 316 L)
Flow pipe	Stainless steel 1.4408 (AISI 316)
Flange, no liquid contact	Cast iron or stainless steel
Bluff body	Stainless steel 1.4401 (AISI 316 L)
Wetted materials	Corrosion-resistant coating, EPDM or FKM, Stainless steel 1.4401/04/08 (AISI 316 L)
Environmental standards	
Enclosure class	IP67, cable connected
Temperature cycling	IEC 68-2-14
Vibration, non-destructive	20-2000 Hz, 10G, 4 h
Electromagnetic compatibility	EN 61326-1
Complete weight	
With cast iron flanges, cable etc	13.2 kg (29.0 lbs)
With stainless steel flanges, cable etc	13.7 kg (30.1 lbs)

VFI and VFI+T2, 12-240 m³/h (53-1057 gpm)

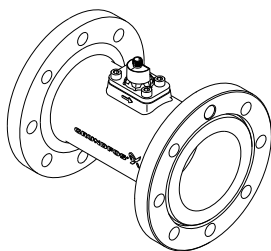

Fig. 29 VFI sensor

TM04 7149 1710

Dimensions

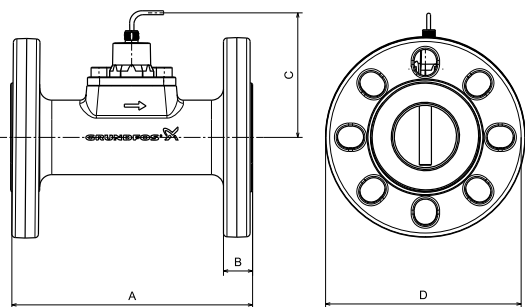

Fig. 30 Dimensions, VFI with flanges

TM04 7154 1610

	A	B	C	D	ISO/DIN flange	
mm	250	25	163	235	DN 100	PN 25/40
in	9.84	0.98	6.42	9.25		

For flanges according to ANSI and JIS standards or for other pressure ranges, contact Grundfos Direct Sensors™. Flanged with PN 16 available upon request.

Sensor output signals

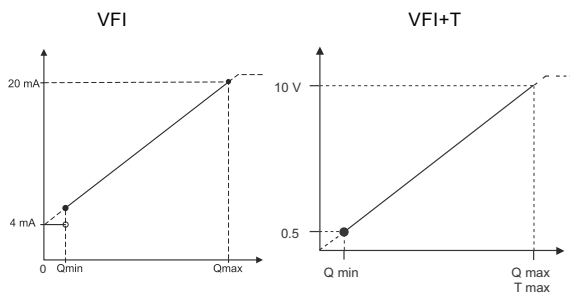

Fig. 31 Flow response

TM06 0951 1316 - TM07 2164 2918

Specifications

Flow	
Measuring range	12-240 m ³ /h (52.83 to 1056.69 gpm)
Accuracy (± 1 σ), 0-100 °C (32-212 °F)	± 1.5 % FS
Response time	Less than 1 s
Resolution	0.30 m ³ /h (1.32 gpm)
Temperature, VFI+T with temperature output	
Measuring range	-10 - 120 °C (14-248 °F)
Accuracy (± 1 σ), 15-90 °C (59-194 °F)	± 0.5 K
Accuracy (± 1 σ), -10 - 120 °C (14-248 °F)	± 1 K
Response time (63.2 % at 50 % FS flow)	250 ms
Resolution	0.1 K
System conditions and environment	
Liquid types	Aqueous media compatible with wetted materials. Kinematic viscosity less than or equal to 6 mm ² /s (cSt). See appendix <i>Pressure drop curves</i>
Maximum system pressure	30 bar (435 psig)
Burst pressure	40 bar (580 psig)
Liquid temperature, operation	-30 to +110 °C (-22 to +230 °F), non-freezing
Liquid temperature, peak	-30 to +110 °C (-22 to +230 °F), non-freezing
Ambient temperature, operation	-25 to +60 °C (-13 to +140 °F)
Ambient temperature, peak	-55 to +70 °C (-67 to +158 °F)
Storage temperature	-55 to +70 °C (-67 to +158 °F)
Humidity, relative	0-95 %, non-condensing
Electrical data	
Power supply	12.5 - 30 VDC (± 5 %)
Output signals	4-20 mA
– Signal cut off	21 mA
Maximum power consumption	660 mW
Maximum load impedance	60 Ω at 12.5 VDC 100 Ω at 13.3 VDC 600 Ω at 24 VDC 900 Ω at 30 VDC
Maximum cable length	30 m (98 ft)
Electrical data, VFI+T with temperature output	
Power supply	16.6 - 30 VDC
Output signals	0-10 VDC
– Signal cut off	(-10 °C at 0 V, 120 °C at 10 V) 11 VDC
Maximum power consumption	270 mW
Maximum load impedance	10 kΩ
Maximum cable length	30 m (98 ft)
Materials	
Sensing element	Silicon-based MEMS
O-ring	EPDM or FKM
Housing	Stainless steel 1.4404 (AISI 316 L)
Flow pipe	Stainless steel 1.4408 (AISI 316)
Flange, no liquid contact	Cast iron or stainless steel
Bluff body	Stainless steel 1.4401 (AISI 316 L)
Wetted materials	Corrosion-resistant coating, EPDM or FKM, Stainless steel 1.4401/04/08 (AISI 316 L)
Environmental standards	
Enclosure class	IP67, cable connected
Temperature cycling	IEC 68-2-14
Vibration, non-destructive	20-2000 Hz, 10G, 4 h
Electromagnetic compatibility	EN 61326-1
Complete weight	
With cast iron flanges, cable etc	18.1 kg (39.8 lbs)
With stainless steel flanges, cable etc	18.1 kg (39.8 lbs)

4. Vortex Flow sensor, Standard (VFS and VFS QT)

General data



Fig. 32 VFS and VFS QT sensors

TM05 4745 2412

Technical overview

The VFS is a combined flow and temperature sensor (two-in-one) from Grundfos Direct Sensors™. The sensor is based on the principle of vortex shedding behind a bluff body.

The VFS sensor is fully compatible with wet, aggressive liquids. The sensor is based on MEMS sensing technology in combination with the corrosion-resistant Silicoat® coating technology on the sensor chip.

The sensor is supplied with a flow pipe.

Applications

- Pump control
- HVAC systems
- temperature control and chiller systems
- renewable energies such as heat pumps, solar thermals, fresh water and micro-CHP systems
- monitoring and control systems
- water treatment plants
- water utility and distribution systems
- HPC (High-Performance Computing) and IT cooling systems.

Features and benefits

- Measurement principle with no movable parts, resulting in no wear and tear
- flow and temperature measurement in one sensor (two-in-one solution) for easy and cost-efficient installation
- MEMS technology
- direct contact with the aqueous media resulting in a fast response time
- plug and play for quick setup
- smart system solution with Grundfos pump controls
- compact and robust design
- compatible with aqueous media
- suitable for a wide temperature range
- suitable for a wide range of applications.
- For aqueous media below 2 µS/cm contact your local Grundfos sensor representative.

Flow range

l/min	gpm
1-18	0.26 - 4.76
1.3 - 20	0.34 - 5.28
2-40	0.53 - 10.57
5-100	1.32 - 26.42
10-200	2.64 - 52.83
20-400	5.28 - 105.67

Approvals (w/EPDM O-rings)

- WRAS
- KTW
- AS4020
- ACS.

Certificates



Electrical connections

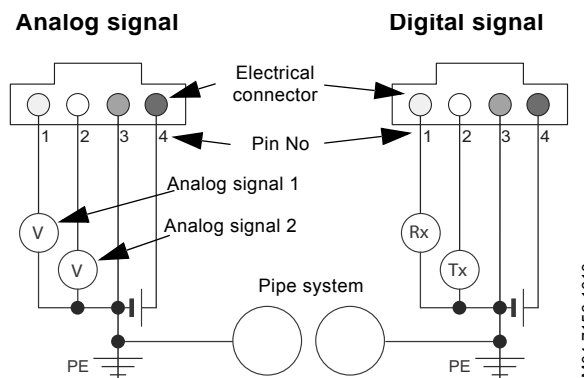

Fig. 33 Electrical connections

TM04 7156 1610

Pin	Description Analogue signal	Description Digital signal	Colour
1	Temperature signal	Rx	Yellow
2	Pressure signal	Tx	White
3	GND, 0 V PELV	GND, 0 V PELV	Green
4	Voltage supply, +5 VDC	Power supply, +5 VDC	Brown

Power supply requirements

- 5 VDC ± 5 %, PELV
- Ratiometric
- Max. 10 mV ripple: 50 Hz
- Min. output current: 25 mA
- Separated from hazardous live circuitry by double or reinforced insulation.
- Grounding of the sensor supply is required.

Directives

The Grundfos Direct Sensors™ are in conformity with these council directives on the approximation of the laws of the EC member states:

- Low Voltage Directive (2014/35/EU)
 - Standards used: EN 61010-1:2010
- EMC Directive (2014/30/EU).
 - Standards used: EN 61326-1:2013 and EN 61326-2-3:2013

The Grundfos Direct Sensors™ are exempted from the Pressure Equipment Directive (PED) according to Article 4, paragraph 3 in the PED 2014/68/EU.

VFS sensors



TM05 4744 2512

Fig. 34 The VFS family

The VFS flow sensor consists of a composite flow pipe and a sensor fitted with cable.

The VFS flow sensor is available in 1-20, 2-40, 5-100, 10-200, 20-400 l/min versions.

VFS QT sensors



TM05 4743 2512

Fig. 35 The VFS QT family

The VFS QT flow sensor consists of a composite insert, a stainless steel flow pipe and a sensor fitted with cable.

The VFS QT flow sensor is available in 1-18, 2-40, 5-100, 10-200 l/min versions.

Snap-on sensor



TM05 4750 2512 - TM05 4752 2512

Fig. 36 Snap-on sensor

Differential Temperature

The differential temperature is between two standard Direct Sensors™ from Grundfos.

VFS, 1-20 l/min (0.2 - 5.3 gpm)



Fig. 37 VFS, 1-20 l/min

Dimensions

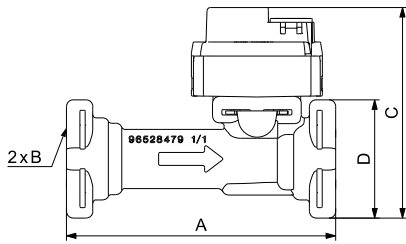

Fig. 38 Dimensions, VFS, 1-20 l/min, without adapter

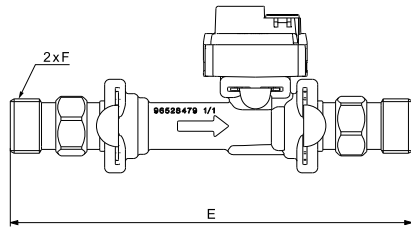

Fig. 39 Dimensions, VFS, 1-20 l/min, with adapters

	A	B	C	D	E	F
mm	82	∅19.8	65	36	153.6	ISO 228 - G 1/2 A
in	3.23	∅0.78	2.56	1.42	6.05	1/2" NPT

Sensor output signals

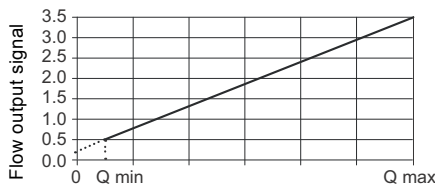

Fig. 40 Flow response in Analogue mode

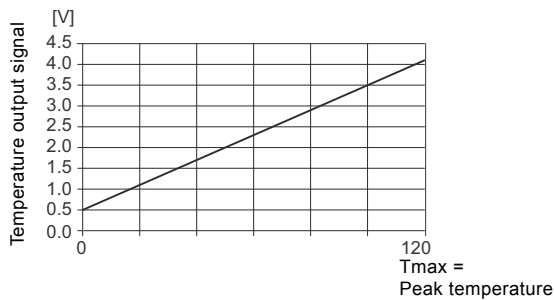

Fig. 41 Temperature response in Analogue mode

Specifications

Flow	
Measuring range	1.3-20 l/min (0.34 to 5.3 gpm)
Accuracy ($\pm 1 \sigma$) in water, 0-120 °C (32-248 °F)	$\pm 1 \%$ FS
Response time (63.2 %)	Less than 1 s
Resolution	max flow/16384 l/min or gpm
Temperature	
Measuring range	0-120 °C (32-248 °F)
Accuracy ($\pm 1 \sigma$), 15-90 °C (59-194 °F)	± 0.5 K
Accuracy ($\pm 1 \sigma$), 0-120 °C (32-248 °F)	± 1 K
Response time (63.2 % at 50 % FS flow)	250 ms
Resolution	0.006 K
Differential Temperature	
Accuracy 15-90 °C (59-194 °F)	0.3 K
Accuracy 0-120 °C (32-248 °F)	0.5 K
System conditions and environment	
Liquid types	Aqueous media compatible with wetted materials. Kinematic viscosity less than 2 mm ² /s (cSt)
Liquid temperature, operation	Water: 0-100 °C (32-212 °F)
Liquid temperature, peak	-25 °C (-13 °F), non-freezing 120 °C (248 °F) for 5 minutes, up to 3 weeks in sensor lifetime
Ambient temperature, operation	-25 to +60 °C (-13 to -140 °F)
Ambient temperature, peak	-55 to +90 °C (-67 to 194 °F)
Humidity, relative	0-95 %, non-condensing
Maximum System Pressure	24 bar (348 psig)
Burst Pressure	30 bar (435 psig)
Maximum system pressure examples	Max 10 bar (145 psig) at 100 °C (212 °F)
Electrical data	
Power supply	5 VDC ($\pm 5 \%$), PELV Grounding of sensor supply required
Output signals	Ratiometric
Digital output signals	Grundfos open data protocol
Analog output signals	0.5 - 3.5 V for flow (zero at 0.35 V) 0.5 - 4.1 V for temperature (zero at 0.5 V and 100 °C at 3.5 V)
Power consumption	Appr. 75 mW
Load impedance	> 47 k Ω
Maximum cable length	3 m (9.10 ft)
Materials	
Sensing element	Silicon-based MEMS
Sealing	EPDM O-rings, FKM O-rings or EPDM sealing cap with FKM O-rings
Housing	Composite (PPS, PA66)
Flow pipe	PPA 40-GF
Wetted materials	Corrosion-resistant coating, EPDM or FKM, PPS, PPA 40-GF
Environmental standards	
Enclosure class	IP44, cable connected
Temperature cycling	IEC 68-2-14
Vibration, non-destructive	20-2000 Hz, 10G, 4 h
Electromagnetic compatibility	EN 61326-1

VFS, 2-40 l/min (0.5 - 10.6 gpm)



Fig. 42 VFS, 2-40 l/min

TM05 4749 2512

Dimensions

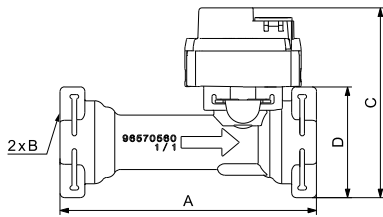

Fig. 43 Dimensions, VFS, 2-40 l/min, without adapter

TM06 3421 0314

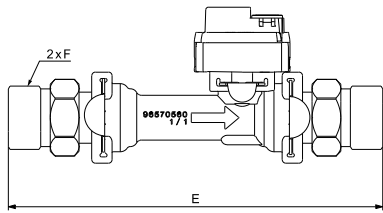

Fig. 44 Dimensions, VFS, 2-40 l/min, with adapters

TM06 3426 0314

	A	B	C	D	E	F
mm	88	∅22.8	66	38	157.4	ISO 228/1 - G 3/4 A
in	3.46	∅0.19	2.60	1.50	6.20	3/4" NPT

Sensor output signals

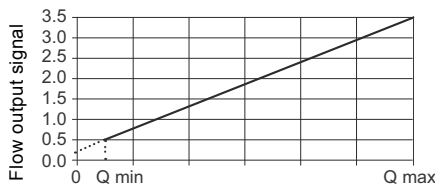

Fig. 45 Flow response in Analogue mode

TM07 2484 3618

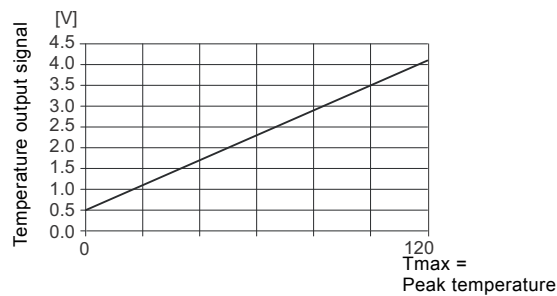

Fig. 46 Temperature response in Analogue mode

TM06 3354 5214

Specifications

Flow	
Measuring range	2-40 l/min (0.5 - 10.6 gpm)
Accuracy ($\pm 1 \sigma$) in water, 0-100 °C (32-212 °F)	$\pm 1 \%$ FS
Response time (63.2 %)	Less than 1 s
Resolution	max flow/16384 l/min or gpm
Temperature	
Measuring range	0-120 °C (32-248 °F)
Accuracy ($\pm 1 \sigma$), 15-90 °C (59-194 °F)	± 0.5 K
Accuracy ($\pm 1 \sigma$), 0-120 °C (32-248 °F)	± 1 K
Response time (63.2 % at 50 % FS flow)	250 ms
Resolution	0.006 K
Differential Temperature	
Accuracy 15-90 °C (59-194 °F)	0.3 K
Accuracy 0-120 °C (32-248 °F)	0.5 K
System conditions and environment	
Liquid types	Aqueous media compatible with wetted materials. Kinematic viscosity less than or equal to 2 mm ² /s (cSt)
Liquid temperature, operation	Water: 0-100 °C (32-212 °F)
Liquid temperature, peak	-25 °C (-13 °F), non-freezing 120 °C (248 °F) for 5 minutes, up to 3 weeks in sensor lifetime
Ambient temperature, operation	-25 to +60 °C (-13 to +140 °F)
Ambient temperature, peak	-55 to +90 °C (-67 to +194 °F)
Humidity, relative	0-95 %, non-condensing
Maximum System Pressure	24 bar (348 psig)
Burst Pressure	30 bar (435 psig)
Maximum system pressure examples	Max 10 bar (145 psig) at 100 °C (212 °F)
Electrical data	
Power supply	5 VDC ($\pm 5 \%$), PELV Grounding of sensor supply required
Output signals	Ratiometric
Digital output signals	Grundfos open data protocol
Analog output signals	0.5 - 3.5 V for flow (zero at 0.35 V) 0.5 - 4.1 V for temperature (zero at 0.5 V and 100 °C at 3.5 V)
Power consumption	Appr. 75 mW
Load impedance	> 47 k Ω
Maximum cable length	3 m (9.10 ft)
Materials	
Sensing element	Silicon-based MEMS
Sealing	EPDM-O-rings or FKM O-rings or EPDM sealing cap with FKM O-rings
Housing	Composite (PPS, PA66)
Flow pipe	PPA 40-GF
Wetted materials	Corrosion-resistant coating, EPDM or FKM, PPS, PPA 40-GF
Environmental standards	
Enclosure class	IP44, cable connected
Temperature cycling	IEC 68-2-14
Vibration, non-destructive	20-2000 Hz, 10G, 4 h
Electromagnetic compatibility	EN 61326-1

VFS, 5-100 l/min (1.3 - 26 gpm)



Fig. 47 VFS, 5-100 l/min

TM05 4748 2512

Dimensions

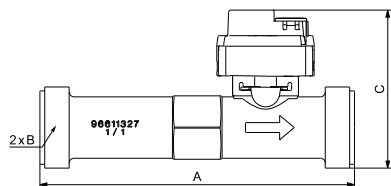

Fig. 48 Dimensions, VFS, 5-100 l/min, without adapter

TM06 3422 0314

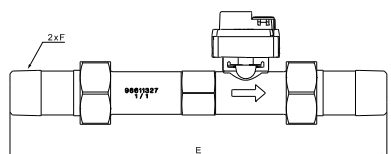

Fig. 49 Dimensions, VFS, 5-100 l/min, with adapters

TM06 3427 0314

	A	B	C	D	E	F
mm	129	ISO 228/1 - G 1 A	65	-	223	ISO 7/1 - Rc 3/4
in	5.08		2.56	-	8.78	3/4" NPT

Sensor output signals

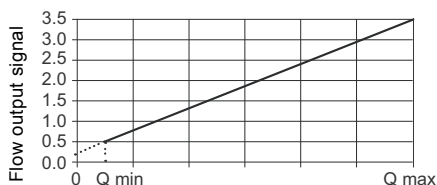

Fig. 50 Flow response in Analog mode

TM07 2484 3618

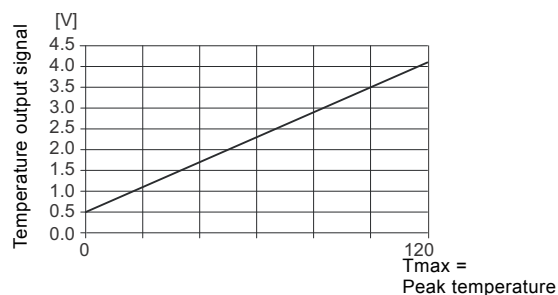

Fig. 51 Temperature response in Analogue mode

TM06 3354 5214

Specifications

Flow	
Measuring range	5-100 l/min (1.3 to 26.4 gpm)
Accuracy ($\pm 1 \sigma$) in water, 0-100 °C (32-212 °F)	$\pm 1 \%$ FS
Response time (63.2 %)	Less than 1 s
Resolution	max flow/16384 l/min or gpm
Temperature	
Measuring range	0-120 °C (32-248 °F)
Accuracy ($\pm 1 \sigma$), 15-90 °C (59-194 °F)	± 0.5 K
Accuracy ($\pm 1 \sigma$), 0-120 °C (32-248 °F)	± 1 K
Response time (63.2 % at 50 % FS flow)	250 ms
Resolution	0.006 K
Differential Temperature	
Accuracy 15-90 °C (59-194 °F)	0.3 K
Accuracy 0-120 °C (32-248 °F)	0.5 K
System conditions and environment	
Liquid types	Aqueous media compatible with wetted materials. Kinematic viscosity less than or equal to 2 mm ² /s (cSt)
Liquid temperature, operation	Water: 0-100 °C (32-212 °F) -25 °C (-13 °F), non-freezing
Liquid temperature, peak	120 °C (248 °F) for 5 minutes, up to 3 weeks in sensor lifetime
Ambient temperature, operation	-25 to +60 °C (-13 to +140 °F)
Ambient temperature, peak	-55 to +90 °C (-67 to +194 °F)
Humidity, relative	0-95 %, non-condensing
Maximum System Pressure	24 bar (348 psig)
Burst Pressure	30 bar (435 psig)
Maximum system pressure examples	Max 10 bar (145 psig) at 100 °C (212 °F)
Electrical data	
Power supply	5 VDC ($\pm 5 \%$), PELV Grounding of sensor supply required
Output signals	Ratiometric
Digital output signals	Grundfos open data protocol
Analogue output signals	0.5 - 3.5 V for flow (zero at 0.35 V) 0.5 - 4.1 V for temperature (zero at 0.5 V and 100 °C at 3.5 V)
Power consumption	Appr. 75 mW
Load impedance	> 47 k Ω
Maximum cable length	3 m (9.10 ft)
Materials	
Sensing element	Silicon-based MEMS
Sealing	EPDM O-rings, FKM O-rings or EPDM sealing cap with FKM O-rings
Housing	Composite (PPS, PA66)
Flow pipe	PPA 40-GF
Wetted materials	Corrosion-resistant coating, EPDM or FKM, PPS, PPA 40-GF
Environmental standards	
Enclosure class	IP44, cable connected
Temperature cycling	IEC 68-2-14
Vibration, non-destructive	20-2000 Hz, 10G, 4 h
Electromagnetic compatibility	EN 61326-1

VFS, 10-200 l/min (2.6 - 53 gpm)



Fig. 52 VFS, 10-200 l/min

TM05 4747 2512

Dimensions

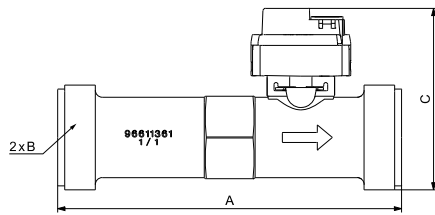

Fig. 53 Dimensions, VFS, 10-200 l/min, without adapter

TM06 3423 0314

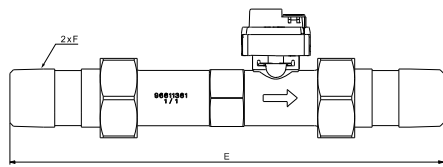

Fig. 54 Dimensions, VFS, 10-200 l/min, with adapters

TM06 3428 0314

	A	B	C	D	E	F
mm	137.5	ISO 228/1 -	73	-	252	ISO 7/1-R 1
in	5.41	G 1 1/4 A	2.87	-	9.92	1" NPT

Sensor output signals

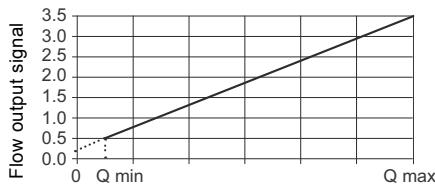

Fig. 55 Flow response in Analogue mode

TM07 2484 3618

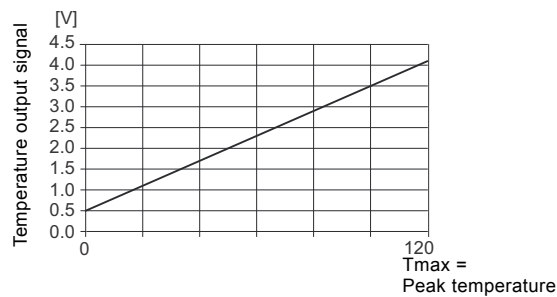

Fig. 56 Temperature response in Analogue mode

TM06 3354 5214

Specifications

Flow	
Measuring range	10-200 l/min (2.6 to 52.8 gpm)
Accuracy ($\pm 1 \sigma$) in water, 0-100 °C (32-212 °F)	$\pm 1 \%$ FS
Response time (63.2 %)	Less than 1 s
Resolution	max flow/16384 l/min or gpm
Temperature	
Measuring range	0-120 °C (32-248 °F)
Accuracy ($\pm 1 \sigma$), 15-90 °C (59-194 °F)	± 0.5 K
Accuracy ($\pm 1 \sigma$), 0-120 °C (32-248 °F)	± 1 K
Response time (63.2 % at 50 % FS flow)	250 ms
Resolution	0.35 K
Differential Temperature	
Accuracy 15-90 °C (59-194 °F)	0.3 K
Accuracy 0-120 °C (32-248 °F)	0.5 K
System conditions and environment	
Liquid types	Aqueous media compatible with wetted materials. Kinematic viscosity less than or equal to 2 mm ² /s (cSt)
Liquid temperature, operation	Water: 0-100 °C (32-212 °F)
Liquid temperature, peak	-25 °C (-13 °F), non-freezing 120 °C (248 °F) for 5 minutes, up to 3 weeks in sensor lifetime
Ambient temperature, operation	-25 to +60 °C (-13 to +140 °F)
Ambient temperature, peak	-55 to +90 °C (-67 to +194 °F)
Humidity, relative	0-95 %, non-condensing
Maximum System Pressure	24 bar (348 psig)
Burst Pressure	30 bar (435 psig)
Maximum system pressure examples	Max 10 bar (145 psig) at 100 °C (212 °F)
Electrical data	
Power supply	5 VDC ($\pm 5 \%$), PELV Grounding of sensor supply required
Output signals	Ratiometric
Digital output signals	Grundfos open data protocol
Analogue output signals	0.5 - 3.5 V for flow (zero at 0.35 V) 0.5 - 4.1 V for temperature (zero at 0.5 V and 100 °C at 3.5 V)
Power consumption	Appr. 75 mW
Load impedance	> 47 k Ω
Maximum cable length	3 m (9.10 ft)
Materials	
Sensing element	Silicon-based MEMS
Sealing	EPDM-O-rings or FKM O-rings or EPDM sealing cap with FKM O-rings
Housing	Composite (PPS, PA66)
Flow pipe	PPA 40-GF
Wetted materials	Corrosion-resistant coating, EPDM or FKM, PPS, PPA 40-GF
Environmental standards	
Enclosure class	IP44, cable connected
Temperature cycling	IEC 68-2-14
Vibration, non-destructive	20-2000 Hz, 10G, 4 h
Electromagnetic compatibility	EN 61326-1

VFS, 20-400 l/min (5.3 - 106 gpm)



Fig. 57 VFS, 20-400 l/min

TM05 4746 2512

Dimensions

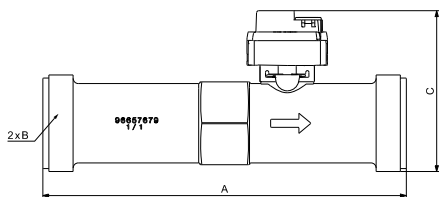

Fig. 58 Dimensions, VFS, 20-400 l/min, without adapter

TM06 3424 0314

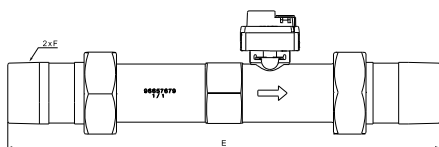

Fig. 59 Dimensions, VFS 20-400 l/min, with adapters

TM06 3429 0314

	A	B	C	D	E	F
mm	180	ISO 228/1 -	80	-	293	ISO 7/1- R
		G 1 1/2 A				1 1/4
in	7.09		3.15	-	11.54	1 1/4" NPT

Sensor output signals

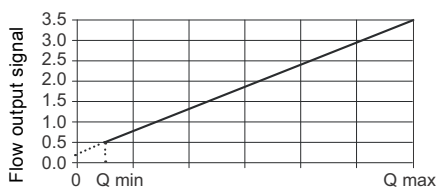

Fig. 60 Flow response in Analogue mode

TM07 2484 3618

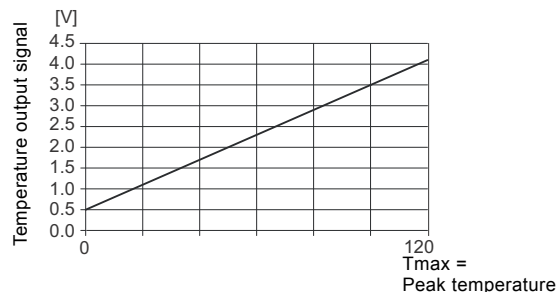

Fig. 61 Temperature response in Analogue mode

TM06 3354 5214

Specifications

Flow	
Measuring range	20-400 l/min (5.3 to 105.7 gpm)
Accuracy ($\pm 1 \sigma$), 0-120 °C (32-248 °F)	$\pm 1 \% FS$
Response time (63.2 %)	Less than 1 s
Resolution	max flow/16384 l/min or gpm
Temperature	
Measuring range	0-120 °C (32-248 °F)
Accuracy ($\pm 1 \sigma$), 15-90 °C (59-194 °F)	$\pm 0.5 K$
Accuracy ($\pm 1 \sigma$), 0-120 °C (32-248 °F)	$\pm 1 K$
Response time (63.2 % at 50 % FS flow)	250 ms
Resolution	0.006 K
Differential Temperature	
Accuracy 15-90 °C (59-194 °F)	0.3 K
Accuracy 0-120 °C (32-248 °F)	0.5 K
System conditions and environment	
Liquid types	Aqueous media compatible with wetted materials. Kinematic viscosity less than or equal to 2 mm ² /s (cSt)
Liquid temperature, operation	Water: 0-100 °C (32-212 °F)
Liquid temperature, peak	-25 °C (-13 °F), non-freezing 120 °C (248 °F) for 5 minutes, up to 3 weeks in sensor lifetime
Ambient temperature, operation	-25 to +60 °C (-13 to +140 °F)
Ambient temperature, peak	-55 to +90 °C (-67 to +194 °F)
Humidity, relative	0-95 %, non-condensing
Maximum System Pressure	24 bar (348 psig)
Burst Pressure	30 bar (435 psig)
Maximum system pressure examples	Max 10 bar (145 psig) at 100 °C (212 °F)
Electrical data	
Power supply	5 VDC ($\pm 5 \%$), PELV Grounding of sensor supply required
Output signals	Ratiometric
Digital output signals	Grundfos open data protocol
Analog output signals	0.5 - 3.5 V for flow (zero at 0.35 V) 0.5 - 4.1 V for temperature (zero at 0.5 V and 100 °C at 3.5 V)
Power consumption	Appr. 75 mW
Load impedance	> 47 k Ω
Maximum cable length	3 m (9.10 ft)
Materials	
Sensing element	Silicon-based MEMS
Sealing	EPDM O-rings, FKM O-rings or EPDM sealing cap with FKM O-rings
Housing	Composite (PPS, PA66)
Flow pipe	PPA 40-GF
Wetted materials	Corrosion-resistant coating, EPDM or FKM, PPS, PPA 40-GF
Environmental standards	
Enclosure class	IP44, cable connected
Temperature cycling	IEC 68-2-14
Vibration, non-destructive	20-2000 Hz, 10G, 4 h
Electromagnetic compatibility	EN 61326-1

VFS QT, 1-18 l/min (0.2 - 4.8 gpm)



Fig. 62 VFS QT, 1-18 l/min

TM05 4741 2512

Dimensions

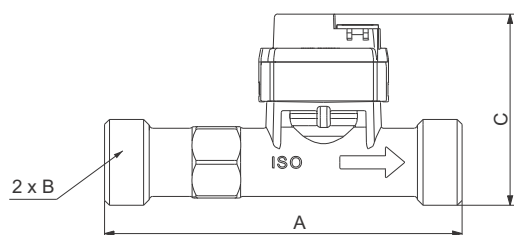

Fig. 63 Dimensions, VFS QT, 1-18 l/min, with threads

TM05 4671 2512

	A	B	C
mm	110	ISO 228/1 - G3/4 A	58.8
in	4.33		2.31

Sensor output signals

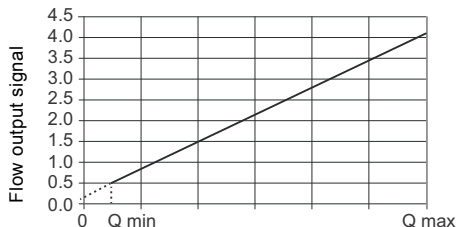

Fig. 64 Flow response in Analogue mode

TM07 2747 4118

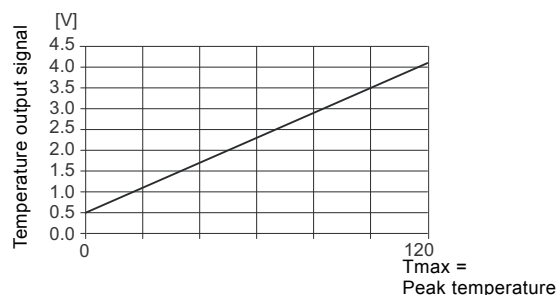

Fig. 65 Temperature response in Analogue mode

TM06 3354 5214

Specifications

Flow	
Measuring range	1-18 l/min (0.2 to 4.8 gpm)
Accuracy ($\pm 1 \sigma$) in water, 0-120 °C (32-248 °F)	$\pm 1\%$ FS
Response time (63.2 %)	Less than 1 s
Resolution	max flow/16384 l/min or gpm
Temperature	
Measuring range	0-120 °C (32-248 °F)
Accuracy ($\pm 1 \sigma$), 15-90 °C (59-194 °F)	± 0.5 K
Accuracy ($\pm 1 \sigma$), 0-120 °C (32-248 °F)	± 1 K
Response time (63.2 % at 50 % FS flow)	250 ms
Resolution	0.006 K
Differential Temperature	
Accuracy 15-90 °C (59-194 °F)	0.3 K
Accuracy 0-120 °C (32-248 °F)	0.5 K
System conditions and environment	
Liquid types	Aqueous media compatible with wetted materials. Kinematic viscosity less than or equal to 2 mm ² /s (cSt)
Liquid temperature, operation	Water: 0-120 °C (32-248 °F)
Liquid temperature, peak	-25 °C (-13 °F), non-freezing 120 °C (248 °F)
Ambient temperature, operation	-25 to +60 °C (-13 to +140 °F)
Ambient temperature, peak	-55 to +90 °C (-67 to +194 °F)
Humidity, relative	0-95 %, non-condensing
Maximum System Pressure	30 bar (435 psig)
Burst Pressure	40 bar (580 psig)
Maximum system pressure examples	Max 16 bar (232 psig) at 100 °C (212 °F) Max 8 bar (116 psig) at 120 °C (248 °F)
Electrical data	
Power supply	5 VDC ($\pm 5\%$), PELV Grounding of sensor supply required
Output signals	Ratiometric
Digital output signals	Grundfos open data protocol
Analogue output signals	0.5 - 4.1 V for flow (zero at 0.28 V and 15 l/m at 3.5 V) 0.5 - 4.1 V for temperature (zero at 0.5 V and 100 °C at 3.5 V)
Power consumption	Appr. 75 mW
Load impedance	> 47 k Ω
Maximum cable length	3 m (9.10 ft)
Materials	
Sensing element	Silicon-based MEMS
Sealing	EPDM O-rings, FKM O-rings or EPDM sealing cap with FKM O-rings
Housing	Composite (PPS, PA66)
Flow pipe	Stainless steel AISI 316 EN 1.4408
Insert	PPA 40 GF
Wetted materials	Corrosion-resistant coating EPDM or FKM, PPS, PPA 40-GF, 1.4408
Environmental standards	
Enclosure class	IP44, cable connected
Temperature cycling	IEC 68-2-14
Vibration, non-destructive	20-2000 Hz, 10G, 4 h
Electromagnetic compatibility	EN 61326-1

VFS QT, 2-40 l/min (0.5 - 10.6 gpm)



Fig. 66 VFS QT, 2-40 l/min

TM05 4741 2512

Dimensions

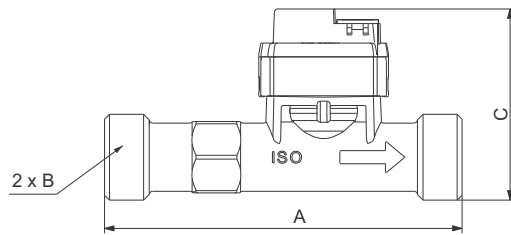

Fig. 67 Dimensions, VFS QT, 2-40 l/min, with threads

TM05 4671 2512

	A	B	C
mm	110	ISO 228/1 - G3/4 A	58.8
in	4.33		2.31

Sensor output signals

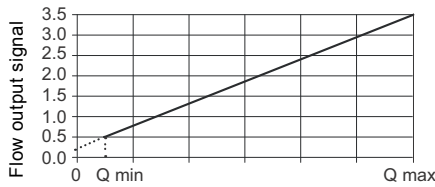

Fig. 68 Flow response in Analogue mode

TM07 2484 3618

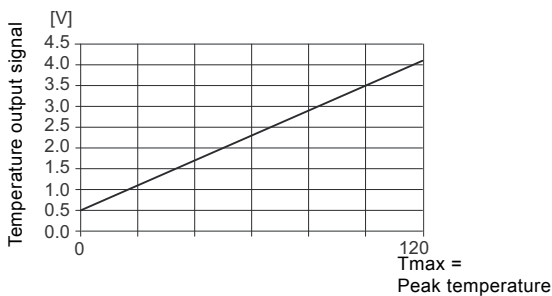

Fig. 69 Temperature response in Analogue mode

TM06 3354 5214

Specifications

Flow	
Measuring range	2-40 l/min (0.5 - 10.6 gpm)
Accuracy ($\pm 1 \sigma$) in water, 0-120 °C (32-248 °F)	$\pm 1 \%$ FS
Response time (63.2 %)	Less than 3 s
Resolution	max flow/16384 l/min or gpm
Temperature	
Measuring range	0-120 °C (32-248 °F)
Accuracy ($\pm 1 \sigma$), 15-90 °C (59-194 °F)	± 0.5 K
Accuracy ($\pm 1 \sigma$), 0-120 °C (32-248 °F)	± 1 K
Response time (63.2 % at 50 % FS flow)	250 ms
Resolution	0.006 K
Differential Temperature	
Accuracy 15-90 °C (59-194 °F)	0.3 K
Accuracy 0-120 °C (32-248 °F)	0.5 K
System conditions and environment	
Liquid types	Aqueous media compatible with wetted materials. Kinematic viscosity less than or equal to 2 mm ² /s (cSt)
Liquid temperature, operation	Water: 0-100 °C (32-212 °F)
Liquid temperature, peak	-25 °C (-13 °F), non-freezing 120 °C (248 °F)
Ambient temperature, operation	-25 to +60 °C (-13 to +140 °F)
Ambient temperature, peak	-55 to +90 °C (-67 to +194 °F)
Humidity, relative	0-95 %, non-condensing
Maximum System Pressure	30 bar (435 psig)
Burst Pressure	40 bar (580 psig)
Maximum system pressure examples	Max 16 bar (232 psig) at 100 °C (212 °F) Max 8 bar (116 psig) at 120 °C (248 °F)
Electrical data	
Power supply	5 VDC ($\pm 5 \%$), PELV Grounding of sensor supply required
Output signals	Ratiometric
Digital output signals	Grundfos open data protocol
Analog output signals	0.5 - 3.5 V for flow (zero at 0.35 V) 0.5 - 4.1 V for temperature (zero at 0.5 V and 100 °C at 3.5 V)
Power consumption	Appr. 75 mW
Load impedance	> 47 k Ω
Maximum cable length	3 m (9.10 ft)
Materials	
Sensing element	Silicon-based MEMS
Sealing	EPDM O-rings, FKM O-rings or EPDM sealing cap with FKM O-rings
Housing	Composite (PPS, PA66)
Flow pipe	Stainless steel AISI 316 EN 1.4408
Insert	PPA 40 GF
Wetted materials	Corrosion-resistant coating, EPDM or FKM, PPS, PPA 40-GF, 1.4408
Environmental standards	
Enclosure class	IP44, cable connected
Temperature cycling	IEC 68-2-14
Vibration, non-destructive	20-2000 Hz, 10G, 4 h
Electromagnetic compatibility	EN 61326-1

VFS QT, 5-100 l/min (1.3 - 26 gpm)



Fig. 70 VFS QT, 5-100 l/min

TM05 4740 2512

Dimensions

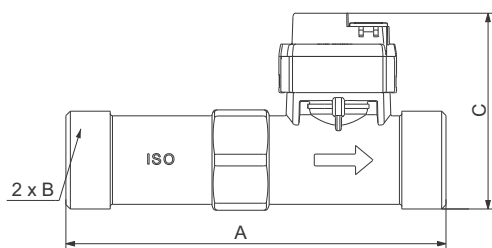

Fig. 71 Dimensions, VFS QT, 5-100 l/min, with threads

TM05 4672 2512

	A	B	C
mm	129	ISO 228/1 - G1A	66.5
in	5.08		2.62

Sensor output signals

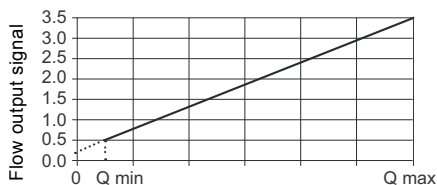

Fig. 72 Flow response in Analogue mode

TM07 2484 3618

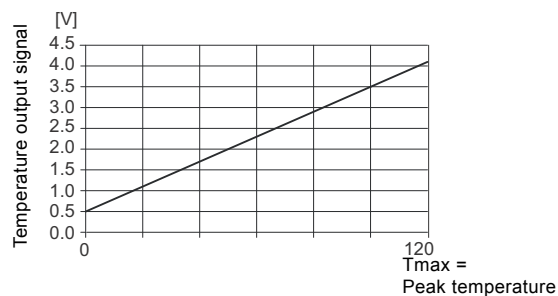

Fig. 73 Temperature response in Analogue mode

TM06 3354 5214

Specifications

Flow	
Measuring range	5-100 l/min (1.3 to 26.4 gpm)
Accuracy ($\pm 1 \sigma$), 0-100 °C (32-212 °F)	$\pm 1 \%$ FS
Response time (63.2 %)	Less than 1 s
Resolution	max flow/16384 l/min or gpm
Temperature	
Measuring range	0-120 °C (32-248 °F)
Accuracy ($\pm 1 \sigma$), 15-90 °C (59-194 °F)	± 0.5 K
Accuracy ($\pm 1 \sigma$), 0-120 °C (32-248 °F)	± 1 K
Response time (63.2 % at 50 % FS flow)	250 ms
Resolution	0.006 K
Differential Temperature	
Accuracy 15-90 °C (59-194 °F)	0.3 K
Accuracy 0-120 °C (32-248 °F)	0.5 K
System conditions and environment	
Liquid types	Aqueous media compatible with wetted materials. Kinematic viscosity less than or equal to 2 mm ² /s (cSt)
Liquid temperature, operation	Water: 0-120 °C (32-248 °F)
Liquid temperature, peak	-25 °C (-13 °F), non-freezing 120 °C (248 °F)
Ambient temperature, operation	-25 to +60 °C (-13 to +140 °F)
Ambient temperature, peak	-55 to +90 °C (-67 to +194 °F)
Humidity, relative	0-95 %, non-condensing
Maximum System Pressure	30 bar (435 psig)
Burst Pressure	40 bar (580 psig)
Maximum system pressure examples	Max 16 bar (232 psig) at 100 °C (212 °F) Max 8 bar (116 psig) at 120 °C (248 °F)
Electrical data	
Power supply	5 VDC ($\pm 5 \%$). We recommend grounding of the sensor supply (PELV).
Output signals	Ratiometric
Digital output signals	Grundfos open data protocol
Analog output signals	0.5 - 3.5 V for flow (zero at 0.35 V) 0.5 - 4.1 V for temperature (zero at 0.5 V and 100 °C at 3.5 V)
Power consumption	Appr. 75 mW
Load impedance	> 47 k Ω
Maximum cable length	3 m (9.10 ft)
Materials	
Sensing element	Silicon-based MEMS
Sealing	EPDM O-rings, FKM O-rings or EPDM sealing cap with FKM O-rings
Housing	Composite (PPS, PA66)
Flow pipe	Stainless steel AISI 316 EN 1.4408
Insert	PPA 40-GF
Wetted materials	Corrosion-resistant coating, EPDM or FKM, PPS, PPA 40-GF, 1.4408
Environmental standards	
Enclosure class	IP44, cable connected
Temperature cycling	IEC 68-2-14
Vibration, non-destructive	20-2000 Hz, 10G, 4 h
Electromagnetic compatibility	EN 61326-1

VFS QT, 10-200 l/min (2.6 - 53 gpm)



Fig. 74 VFS QT, 10-200 l/min

TM05 4739 2512

Dimensions

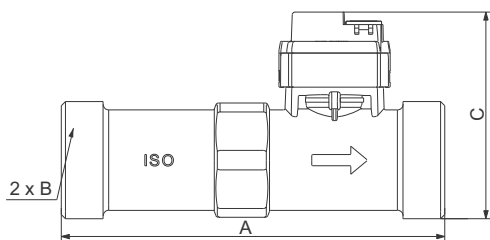

Fig. 75 Dimensions, VFS QT, 10-200 l/min, with threads

TM05 4673 2512

	A	B	C
mm	137.5	ISO 228/1 - G1 1/4 A	74.1
in	5.41		2.92

Sensor output signals

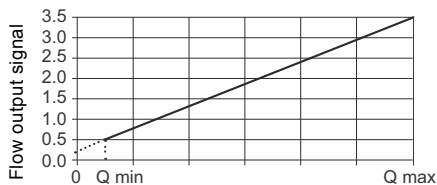

Fig. 76 Flow response in Analogue mode

TM07 2484 3618

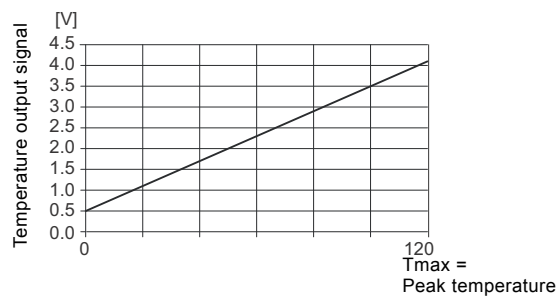

Fig. 77 Temperature response in Analogue mode

TM06 3354 5214

Specifications

Flow	
Measuring range	10-200 l/min (2.6 to 52.8 gpm)
Accuracy ($\pm 1 \sigma$) in water, 0-100 °C (32-212 °F)	$\pm 1 \%$ FS
Response time (63.2 %)	Less than 1.0 s
Resolution	max flow/16384 l/min or gpm
Temperature	
Measuring range	0-120 °C (32-248 °F)
Accuracy ($\pm 1 \sigma$), 15-90 °C (59-194 °F)	± 0.5 K
Accuracy ($\pm 1 \sigma$), 0-120 °C (32-248 °F)	± 1 K
Response time (63.2 % at 50 % FS flow)	250 ms
Resolution	0.006 K
Differential Temperature	
Accuracy 15-90 °C (59-194 °F)	0.3 K
Accuracy 0-120 °C (32-248 °F)	0.5 K
System conditions and environment	
Liquid types	Aqueous media compatible with wetted materials. Kinematic viscosity less than or equal to 2 mm ² /s (cSt)
Liquid temperature, operation	Water: 0-120 °C (32-248 °F)
Liquid temperature, peak	-25 °C (-13 °F), non-freezing 120 °C (248 °F)
Ambient temperature, operation	-25 to +60 °C (-13 to +140 °F)
Ambient temperature, peak	-55 to +90 °C (-67 to +194 °F)
Humidity, relative	0-95 %, non-condensing
Maximum System Pressure	30 bar (435 psig)
Burst Pressure	40 bar (580 psig)
Maximum system pressure examples	Max 16 bar (232 psig) at 100 °C (212 °F) Max 8 bar (116 psig) at 120 °C (248 °F)
Electrical data	
Power supply	5 VDC ($\pm 5 \%$), PELV Grounding of sensor supply required
Output signals	Ratiometric
Digital output signals	Grundfos open data protocol
Analog output signals	0.5 - 3.5 V for flow (zero at 0.35 V) 0.5 - 4.1 V for temperature (zero at 0.5 V and 100 °C at 3.5 V)
Power consumption	Appr. 75 mW
Load impedance	> 47 kΩ
Maximum cable length	3 m (9.10 ft)
Materials	
Sensing element	Silicon-based MEMS
Sealing	EPDM O-rings, FKM O-rings or EPDM sealing cap with FKM O-rings
Housing	Composite (PPS, PA66)
Flow pipe	Stainless steel 1.4408 (AISI 316)
Insert	PPA 40-GF
Wetted materials	Corrosion-resistant coating, EPDM or FKM, PPS, PPA 40-GF, 1.4408
Environmental standards	
Enclosure class	IP44, cable connected
Temperature cycling	IEC 68-2-14
Vibration, non-destructive	20-2000 Hz, 10G, 4 h
Electromagnetic compatibility	EN 61326-1

5. Multi Flow sensor, standard (MFS and MFS QT)

General data



Fig. 78 MFS and MFS QT, 4-40 l/min

TM05 4752 2412 - TM05 4741 2412

Technical overview

The MFS is a combined flow, pressure and temperature sensor (three-in-one) from Grundfos Direct Sensors™. The sensor is based on the principle of vortex shedding behind a bluff body.

The MFS sensor is designed for high-volume production and fully compatible with wet, aggressive liquids.

The sensor is based on MEMS sensing technology in combination with a unique packaging concept using corrosion-resistant coating on the MEMS sensor chip. This makes the sensor very robust and ideal for high-volume OEM (Original Equipment Manufacturer) applications.

Applications

- Pump control
- HVAC systems
- temperature control and chiller systems
- renewable energies such as heat pumps, solar thermals, fresh water and micro-CHP systems
- monitoring and control systems
- water treatment plants
- water utility and distribution systems
- HPC (High-Performance Computing) and IT cooling systems.

Features and benefits

- Flow, pressure and temperature measurement in one sensor (three-in-one solution) for easy and cost-efficient installation
- Measurement principle with no movable parts, resulting in no wear and tear
- self-configuring digital or analog output
- MEMS technology
- direct contact with the liquid resulting in a fast response time
- plug and play for quick setup
- smart system solution with Grundfos pump controls
- compact and robust design
- compatible with aqueous media
- For aqueous media below 2 µS/cm contact your local Grundfos sensor representative

- suitable for a wide temperature range
- suitable for a wide range of application.

Approvals (w/EPDM O-rings)

- WRAS
- KTW
- ACS.

Certificates



Electrical connections

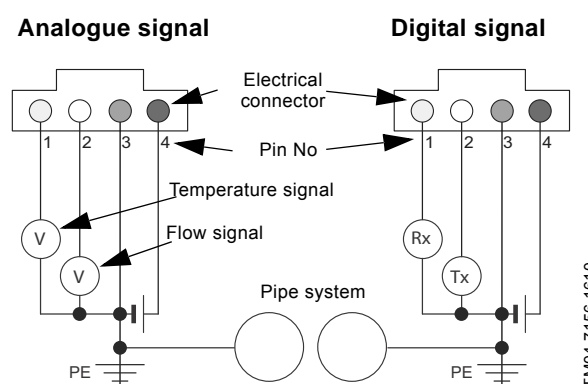

Fig. 79 Electrical connections

TM04 7156 1610

Pin configuration Analog signal	Pin configuration Digital signal	Colour
1 Analog signal 1	Rx	Yellow
2 Analog signal 2	Tx	White
3 GND (0 V), PELV	GND (0 V), PELV	Green
4 Power supply, + 5 VDC	Power supply, + 5 VDC	Brown

Power supply requirements

- 5 VDC ± 5 %, PELV
- maximum 10 mV ripple, 50 Hz
- minimum output current, 25 mA
- separated from hazardous live circuitry by double or reinforced insulation
- grounding of sensor supply is required.

Directives

The Grundfos Direct Sensors™ are in conformity with these council directives on the approximation of the laws of the EC member states:

- Low Voltage Directive (2014/35/EU)
 - Standards used: EN 61010-1:2010
- EMC Directive (2014/30/EU).
 - Standards used: EN 61326-1:2013 and EN 61326-2-3:2013

The Grundfos Direct Sensors™ are exempted from the Pressure Equipment Directive (PED) according to Article 4, paragraph 3 in the PED 2014/68/EU.

MFS sensors



Fig. 80 The MFS family

The MFS flow sensor consists of a composite flow pipe and a sensor fitted with cable.
The MFS flow sensor is available in 2-20, 4-40, 10-100, 20-200, 40-400 l/min versions.

MFS QT sensors



Fig. 81 The MFS QT family

The MFS QT flow sensor consists of a composite insert, a stainless steel flow pipe and a sensor fitted with cable.
The MFS QT flow sensor is available in 2-18, 4-40, 10-100, 20-200 l/min versions.

Snap-on sensor



Fig. 82 Snap-on sensor

Differential Temperature

The differential temperature is between two standard Direct Sensors™ from Grundfos.

TM05 4744 2512

TM05 4750 2512 - TM05 4752 2512

TM05 4743 2512

MFS 2-20 l/min (0.53 - 5.3 gpm)



Fig. 83 MFS 2-20 l/min

Dimensions

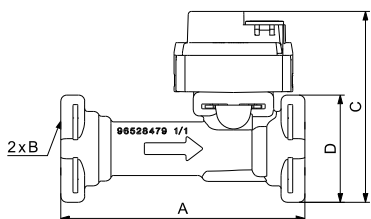

Fig. 84 Dimensions, MFS 2-20 l/min, without adapter

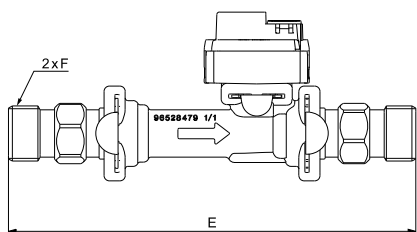

Fig. 85 Dimensions, MFS 2-20 l/min, with adapters

	A	B	C	D	E	F
mm	82	∅19.8	65	36	153.6	ISO 228 - G 1/2 A
in	3.23	∅0.78	2.56	1.42	6.05	1/2" NPT

Sensor output signals

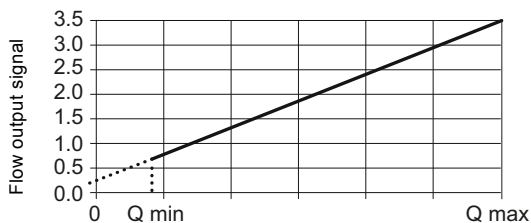

Fig. 86 Flow response in Analogue mode

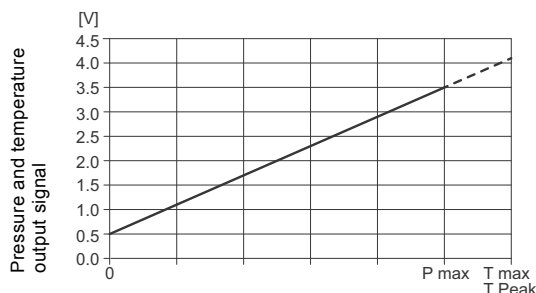

Fig. 87 Pressure and temperature response in Analogue mode

Specifications

Flow	
Measuring range	2-20 l/min (0.53 to 5.3 gpm)
Accuracy ($\pm 1 \sigma$), 0-120 °C (32-248 °F)	$\pm 1 \%$ FS
Response time (63.2 %)	Less than 4 s
Resolution	max flow/16384 l/min or gpm
Pressure	
Measuring range	0-10 bar (0-145 psig)
Accuracy ($\pm 1 \sigma$), 15-90 °C (59-194 °F)	$\pm 2.0 \%$ FS
Accuracy ($\pm 1 \sigma$), 0-120 °C (32-248 °F)	$\pm 2.5 \%$ FS
Response time for sensor electronic	250 ms
Resolution	0.6 mbar (0.009 psig)
Temperature	
Measuring range	0-120 °C (32-248 °F)
Accuracy ($\pm 1 \sigma$), 15-90 °C (59-194 °F)	± 0.5 K
Accuracy ($\pm 1 \sigma$), 0-120 °C (32-248 °F)	± 1 K
Response time (63.2 % at 50 % FS flow)	250 ms
Resolution	0.006 K
Differential Temperature	
Accuracy 15-90 °C (59-194 °F)	0.3 K
Accuracy 0-120 °C (32-248 °F)	0.5 K
System conditions and environment	
Liquids	Aqueous media compatible with wetted materials. Kinematic viscosity less than or equal to 2 mm ² /s (cSt)
System temperature, operation	0-100 °C (32-212 °F)
System temperature, peak	-25 °C (-13 °F), non-freezing 120 °C (248 °F) for 5 minutes, up to 3 weeks in sensor lifetime
Ambient temperature, operation	-25 to +60 °C (-13 to +140 °F)
Ambient temperature, peak	-55 to +90 °C (-67 to +194 °F)
Humidity, relative	0-95 %, non-condensing
Maximum System Pressure	24 bar (348 psig)
Burst Pressure	30 bar (435 psig)
Maximum system pressure example	Max 10 bar (145 psig) at 100 °C (212 °F)
Electrical data	
Power supply	5 VDC ($\pm 5 \%$), PELV Grounding of sensor supply required
Digital output signals	Grundfos open data protocol
Analog output signals, only two signals possible (analogue variants are upon request)	0.5 - 3.5 for flow (zero at 0.35 V) and pressure (zero at 0.5 V) 0.5 - 4.1 V for temperature (zero at 0.5 V and 100 °C at 3.5 V)
Power consumption	Approximately 75 mW
Load impedance	> 47 kΩ
Materials	
Sensing element	Silicon-based MEMS
Sealing	EPDM O-ring or FKM O-ring
Housing	Composite (PPS, PA66)
Flow pipe	PPA 40-GF
Wetted materials	Corrosion-resistant coating, EPDM or FKM, PPS, PPA 40-GF
Environmental standards	
Enclosure class	IP44, cable connected
Temperature cycling	IEC 68-2-14
Vibration, non-destructive	20-2000 Hz, 10G, 4 h
Electromagnetic compatibility	EN 61326-1

MFS 4-40 l/min (1.06 - 10.6 gpm)



Fig. 88 MFS 4-40 l/min

Dimensions

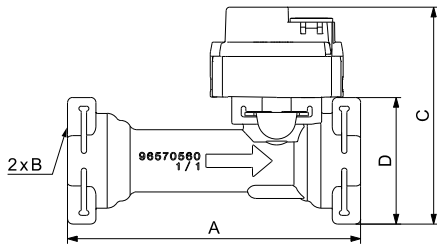

Fig. 89 Dimensions, MFS 4-40 l/min, without adapter

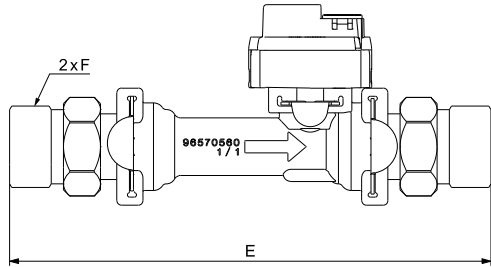

Fig. 90 Dimensions, MFS 4-40 l/min, with adapter

	A	B	C	D	E	F
mm	88	∅22.8	66	38	157.4	ISO 228/1 -G 3/4 A
in	3.46	∅0.19	2.60	1.50	6.20	3/4" NPT

Sensor output signals

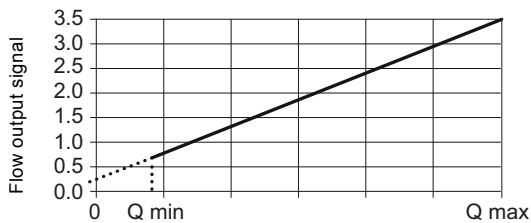

Fig. 91 Flow response in Analogue mode

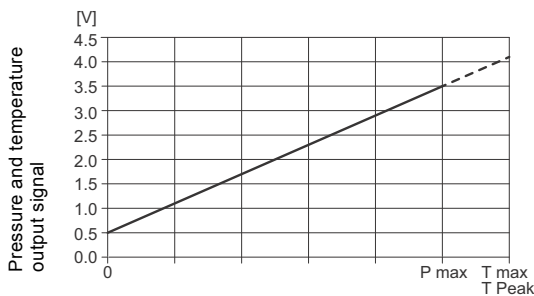

Fig. 92 Pressure and temperature response in Analogue mode

Specifications

Flow	
Measuring range	4-40 l/min (1.06 - 10.6 gpm)
Accuracy ($\pm 1 \sigma$) in water 0-120 °C (32-248 °F)	$\pm 1 \%$ FS
Response time (63.2 %)	Less than 4 s
Resolution	max flow/16384 l/min or gpm
Pressure	
Measuring range	0-10 bar (0-145 psig)
Accuracy ($\pm 1 \sigma$), 15-90 °C (59-194 °F)	$\pm 2.0 \%$ FS
Accuracy ($\pm 1 \sigma$), 0-120 °C (32-248 °F)	$\pm 2.5 \%$ FS
Response time for sensor electronic	250 ms
Resolution	0.6 mbar (0.009 psig)
Temperature	
Measuring range	0-120 °C (32-248 °F).
Accuracy ($\pm 1 \sigma$), 15-90 °C (59-194 °F)	± 0.5 K
Accuracy ($\pm 1 \sigma$), 0-120 °C (32-248 °F)	± 1 K
Response time (63.2 % at 50 % FS flow)	250 ms
Resolution	0.006 K
System conditions and environment	
Liquids	Aqueous media compatible with wetted materials. Kinematic viscosity less than or equal to 2 mm ² /s (cSt)
System temperature, operation	0-100 °C (32-212 °F)
System temperature, peak	-25 °C (-13 °F), non-freezing 120 °C (248 °F) for 5 minutes, up to 3 weeks in sensor lifetime
Ambient temperature, operation	-25 to +60 °C (-13 to +140 °F)
Ambient temperature, peak	-55 to +90 °C (-67 to +194 °F)
Humidity, relative	0-95 %, non-condensing
Maximum System Pressure	24 bar (348 psig)
Burst Pressure	30 bar (435 psig)
Maximum system pressure example	Max 10 bar (145 psig) at 100 °C (212 °F)
Electrical data	
Power supply	5 VDC ($\pm 5 \%$), PELV Grounding of sensor supply required
Digital output signals	Grundfos open data protocol
Analog output signals, only two signals possible (analogue variants are upon request)	0.5 - 3.5 for flow (zero at 0.35 V) and pressure (zero at 0.5 V) 0.5 - 4.1 V for temperature (zero at 0.5 V and 100 °C at 3.5 V)
Power consumption	Approximately 75 mW
Load impedance	> 47 kΩ
Materials	
Sensing element	Silicon-based MEMS
Sealing	EPDM O-ring or FKM O-ring
Housing	Composite (PPS, PA66)
Flow pipe	PPA 40-GF
Wetted materials	Corrosion-resistant coating, EPDM or FKM, PPS, PPA 40-GF
Environmental standards	
Enclosure class	IP44, cable connected
Temperature cycling	IEC 68-2-14
Vibration, non-destructive	20-2000 Hz, 10G, 4 h
Electromagnetic compatibility	EN 61326-1

MFS 10-100 l/min (2.6 - 26 gpm)



Fig. 93 MFS 10-100 l/min

TM05 4748 2512

Dimensions

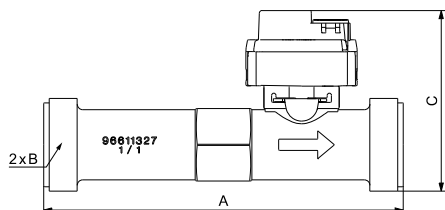

Fig. 94 Dimensions, MFS 10-100 l/min, without adapter

TM06 3422 0314

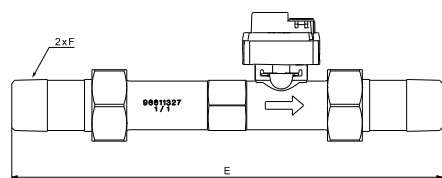

Fig. 95 Dimensions, MFS 10-100 l/min, with adapters

TM06 3427 0314

	A	B	C	D	E	F
mm	129	ISO 228/1 -	65	-	223	ISO 7/1-Rc 3/4
in	5.08	G 1 A	2.56	-	8.78	3/4" NPT

Sensor output signals

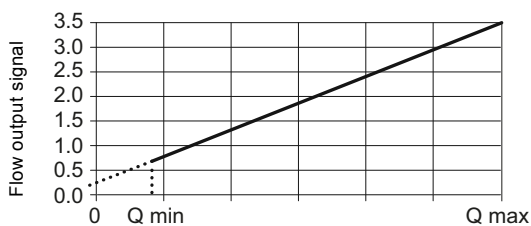

Fig. 96 Flow response in Analogue mode

TM07 2485 3618

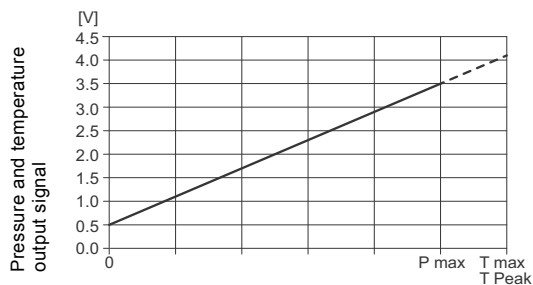

Fig. 97 Pressure and temperature response in Analogue mode

TM06 6560 1716

Specifications

Flow	
Measuring range	10-100 l/min (2.6-26 gpm)
Accuracy ($\pm 1 \sigma$) in water 0-120 °C (32-248 °F)	$\pm 1 \% FS$
Response time (63.2 %)	Less than 4 s
Resolution	max flow/16384 l/min or gpm
Pressure	
Measuring range	0-10 bar (0-145 psig)
Accuracy ($\pm 1 \sigma$), 15-90 °C (59-194 °F)	$\pm 2.0 \% FS$
Accuracy ($\pm 1 \sigma$), 0-120 °C (32-248 °F)	$\pm 2.5 \% FS$
Response time for sensor electronic	250 ms
Resolution	0.6 mbar (0.009 psig)
Temperature	
Measuring range	0-120 °C (32-248 °F)
Accuracy ($\pm 1 \sigma$), 15-90 °C (59-194 °F)	$\pm 0.5 K$
Accuracy ($\pm 1 \sigma$), 0-100 °C (32-212 °F)	$\pm 1 K$
Response time (63.2 % at 50 % FS flow)	250 ms
Resolution	0.006 K
Differential Temperature	
Accuracy 15-90 °C (59-194 °F)	0.3 K
Accuracy 0-120 °C (32-248 °F)	0.5 K
System conditions and environment	
Liquid types	Aqueous media compatible with wetted materials. Kinematic viscosity less than or equal to 2 mm ² /s (cSt)
System temperature, operation	0-100 °C (32-212 °F)
System temperature, peak	-25 °C (-13 °F), non-freezing 120 °C (248 °F) for 5 minutes, up to 3 weeks in sensor lifetime
Ambient temperature, operation	-25 to +60 °C (-13 to +140 °F)
Ambient temperature, peak	-55 to +90 °C (-67 to +194 °F)
Humidity, relative	0-95 %, non-condensing
Maximum System Pressure	24 bar (348 psig)
Burst Pressure	30 bar (435 psig)
Maximum system pressure example	Max 10 bar (145 psig) at 100 °C (212 °F)
Electrical data	
Power supply	5 VDC ($\pm 5 \%$), PELV Grounding of sensor supply required
Digital output signals	Grundfos open data protocol
Analog output signals, only two signals possible (analogue variants are upon request)	0.5 - 3.5 for flow (zero at 0.35 V) and pressure (zero at 0.5 V) 0.5 - 4.1 V for temperature (zero at 0.5 V and 100 °C at 3.5 V)
Power consumption	Approximately 75 mW
Load impedance	> 47 kΩ
Materials	
Sensing element	Silicon-based MEMS
Sealing	EPDM O-ring or FKM O-ring
Housing	Composite (PPS, PA66)
Flow pipe	PPA 40-GF
Wetted materials	Corrosion-resistant coating, EPDM or FKM, PPS, PPA 40-GF
Environmental standards	
Enclosure class	IP44, cable connected
Temperature cycling	IEC 68-2-14
Vibration, non-destructive	20-2000 Hz, 10G, 4 h
Electromagnetic compatibility	EN 61326-1

MFS 20-200 l/min (5.3 - 53 gpm)



Fig. 98 MFS 20-200 l/min

Dimensions

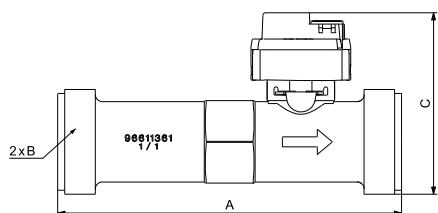

Fig. 99 Dimensions, MFS 20-200 l/min, without adapter

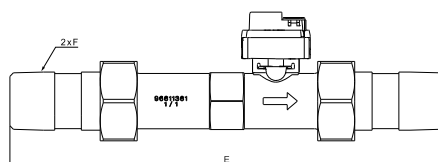

Fig. 100 Dimensions, MFS 20-200 l/min, with adapters

	A	B	C	D	E	F
mm	137.5	ISO 228/1 -	73	-	252	ISO 7/1-R 1
in	5.41	G 1 1/4 A	2.87	-	9.92	1" NPT

Sensor output signals

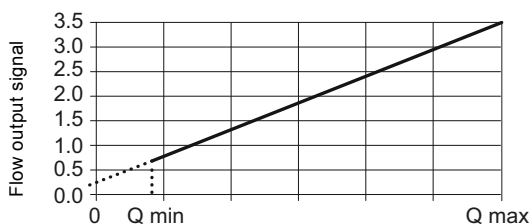

Fig. 101 Flow response in Analogue mode

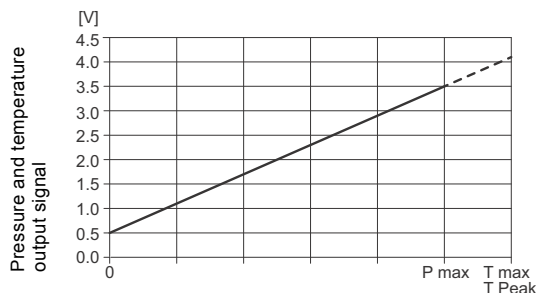

Fig. 102 Pressure and temperature response in Analogue mode

Specifications

Flow	
Measuring range	MFS 20-200 (5.3 - 53 gpm)
Accuracy ($\pm 1 \sigma$) in water 0-120 °C (32-248 °F)	$\pm 1 \%$ FS
Response time (63.2 %)	Less than 4 s
Resolution	max flow/16384 l/min or gpm
Pressure	
Measuring range	0-10 bar (0-145 psig)
Accuracy ($\pm 1 \sigma$), 15-90 °C (59-194 °F)	$\pm 2.0 \%$ FS
Accuracy ($\pm 1 \sigma$), 0-120 °C (32-248 °F)	$\pm 2.5 \%$ FS
Response time for sensor electronic	250 ms
Resolution	0.6 mbar (0.009 psig)
Temperature	
Measuring range	0-120 °C (32-248 °F)
Accuracy ($\pm 1 \sigma$), 15-90 °C (59-194 °F)	± 0.5 K
Accuracy ($\pm 1 \sigma$), 0-120 °C (32-248 °F)	± 1 K
Response time (63.2 % at 50 % FS flow)	250 ms
Resolution	0.006 K
Differential Temperature	
Accuracy 15-90 °C (59-194 °F)	0.3 K
Accuracy 0-120 °C (32-248 °F)	0.5 K
System conditions and environment	
Liquid types	Aqueous media compatible with wetted materials Kinematic viscosity less than or equal to 2 mm ² /s (cSt)
System temperature, operation	0-100 °C (32-212 °F)
System temperature, peak	-25 °C (-13 °F), non-freezing 120 °C (248 °F) for 5 minutes, up to 3 weeks in sensor lifetime
Ambient temperature, operation	-25 to +60 °C (-13 to +140 °F)
Ambient temperature, peak	-55 to +90 °C (-67 to +194 °F)
Humidity, relative	0-95 %, non-condensing
Maximum System Pressure	24 bar (348 psig)
Burst Pressure	30 bar (435 psig)
Maximum system pressure example	Max 10 bar (145 psig) at 100 °C (212 °F)
Electrical data	
Power supply	5 VDC ($\pm 5 \%$), PELV Grounding of sensor supply required
Digital output signals	Grundfos open data protocol
Analog output signals, only two signals possible (analogue variants are upon request)	0.5 - 3.5 for flow (zero at 0.35 V) and pressure (zero at 0.5 V) 0.5 - 4.1 V for temperature (zero at 0.5 V and 100 °C at 3.5 V)
Power consumption	Approximately 75 mW
Load impedance	> 47 kΩ
Materials	
Sensing element	Silicon-based MEMS
Sealing	EPDM O-ring or FKM O-ring
Housing	Composite (PPS, PA66)
Flow pipe	PPA 40-GF
Wetted materials	Corrosion-resistant coating, EPDM or FKM, PPS, PPA 40-GF
Environmental standards	
Enclosure class	IP44, cable connected
Temperature cycling	IEC 68-2-14
Vibration, non-destructive	20-2000 Hz, 10G, 4 h
Electromagnetic compatibility	EN 61326-1

MFS 40-400 l/min (10.6 - 106 gpm)



Fig. 103 MFS 40-400 l/min

TM05 4746 2512

Dimensions

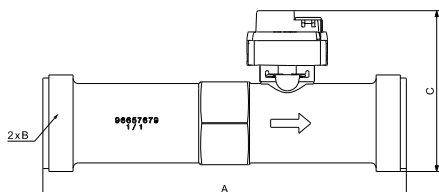

Fig. 104 Dimensions, MFS 40-400 l/min, without adapter

TM06 3424 0314

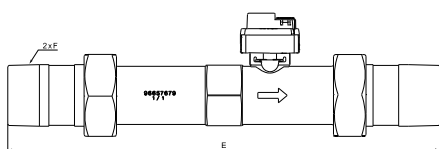

Fig. 105 Dimensions, MFS 40-400 l/min, with adapters

TM06 3429 0314

	A	B	C	D	E	F
mm	180	ISO 228/1 - 80	-	293	ISO 7/1 - R 1 1/4	
in	7.09	G 1 1/2 A	3.15	-	11.54	1 1/4" NPT

Sensor output signals

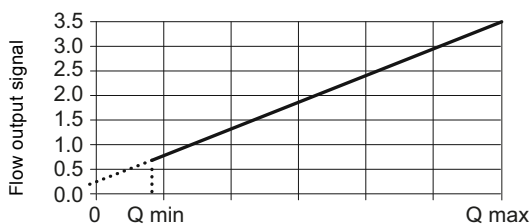

Fig. 106 Flow response in Analogue mode

TM07 2485 3618

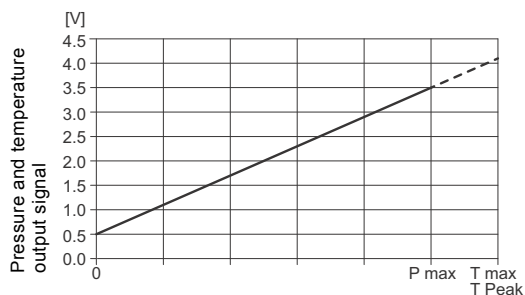

Fig. 107 Pressure and temperature response in Analogue mode

TM06 6560 1716

Specifications

Flow	
Measuring range	MFS 40-400 (10.6 - 106 gpm)
Accuracy ($\pm 1 \sigma$), in water 0-120 °C (32-248 °F)	$\pm 1 \%$ FS
Response time (63.2 %)	Less than 4 s
Resolution	max flow/16384 l/min or gpm
Pressure	
Measuring range	0-10 bar (0-145 psig)
Accuracy ($\pm 1 \sigma$), 15-90 °C (59-194 °F)	$\pm 2.0 \%$ FS
Accuracy ($\pm 1 \sigma$), 0-120 °C (32-248 °F)	$\pm 2.5 \%$ FS
Response time for sensor electronic	250 ms
Resolution	0.6 mbar (0.009 psig)
Temperature	
Measuring range	0-120 °C (32-248 °F)
Accuracy ($\pm 1 \sigma$), 15-90 °C (59-194 °F)	± 0.5 K
Accuracy ($\pm 1 \sigma$), 0-120 °C (32-248 °F)	± 1 K
Response time (63.2 % at 50 % FS flow)	250 ms
Resolution	0.006 K
Differential Temperature	
Accuracy 15-90 °C (59-194 °F)	0.3 K
Accuracy 0-120 °C (32-248 °F)	0.5 K
System conditions and environment	
Liquid types	Aqueous media compatible with wetted materials. Kinematic viscosity less than or equal to 2 mm ² /s (cSt)
System temperature, operation	0-100 °C (32-212 °F)
System temperature, peak	-25 °C (-13 °F), non-freezing 120 °C (248 °F) for 5 minutes, up to 3 weeks in sensor lifetime
Ambient temperature, operation	-25 to +60 °C (-13 to +140 °F)
Ambient temperature, peak	-55 to +90 °C (-67 to +194 °F)
Humidity, relative	0-95 %, non-condensing
Maximum System Pressure	24 bar (348 psig)
Burst Pressure	30 bar (435 psig)
Maximum system pressure example	Max 10 bar (145 psig) at 100 °C (212 °F)
Electrical data	
Power supply	5 VDC ($\pm 5 \%$), PELV Grounding of sensor supply required
Digital output signals	Grundfos open data protocol 0.5 - 3.5 for flow (zero at 0.35 V) and pressure (zero at 0.5 V)
Analog output signals, only two signals possible (analogue variants are upon request)	0.5 - 4.1 V for temperature (zero at 0.5 V and 100 °C at 3.5 V)
Power consumption	Approximately 75 mW
Load impedance	> 47 k Ω
Materials	
Sensing element	Silicon-based MEMS
Sealing	EPDM O-ring or FKM O-ring
Housing	Composite (PPS, PA66)
Flow pipe	PPA 40-GF
Wetted materials	Corrosion-resistant coating, EPDM or FKM, PPS, PPA 40-GF
Environmental standards	
Enclosure class	IP44, cable connected
Temperature cycling	IEC 68-2-14
Vibration, non-destructive	20-2000 Hz, 10G, 4 h
Electromagnetic compatibility	EN 61326-1

MFS QT 2-18 l/min (0.39 - 4.8 gpm)

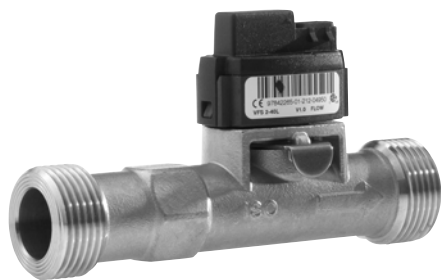

Fig. 108 MFS QT 2-18 l/min

TM05 4741 2512

Dimensions

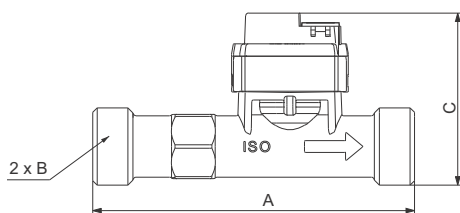

Fig. 109 Dimensions, MFS QT 2-18 l/min, with threads

TM05 4671 2512

	A	B	C
mm	110	ISO 228/1 - G3/4 A	58.8
in	4.33		2.31

Sensor output signals

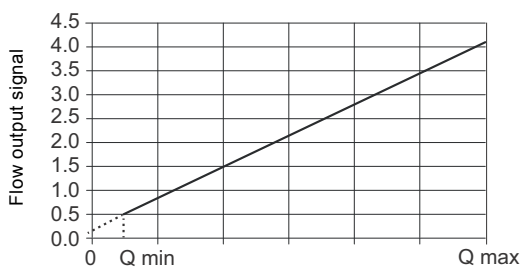

Fig. 110 Flow response in Analogue mode

TM07 2747 4118

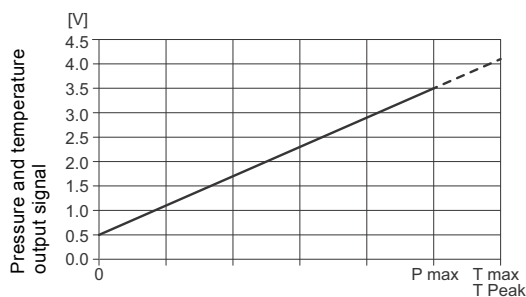

Fig. 111 Pressure and temperature response in Analogue mode

TM06 6560 1716

Specifications

Flow	
Measuring range	2-18 l/min (0.39 - 4.8 gpm)
Accuracy ($\pm 1 \sigma$) in water, 0-120 °C (32-248 °F)	$\pm 1 \%$ FS
Response time (63.2 %)	Less than 4 s
Resolution	max flow/16384 l/min or gpm
Pressure	
Measuring range	0-10 bar (0-145 psig)
Accuracy ($\pm 1 \sigma$), 15-90 °C (59-194 °F)	$\pm 2.0 \%$ FS
Accuracy ($\pm 1 \sigma$), 0-120 °C (32-248 °F)	$\pm 2.5 \%$ FS
Response time for sensor electronic	250 ms
Resolution	0.6 mbar (0.009 psig)
Temperature	
Measuring range	0-120 °C (32-248 °F)
Accuracy ($\pm 1 \sigma$), 15-90 °C (59-194 °F)	± 0.5 K
Accuracy ($\pm 1 \sigma$), 0-120 °C (32-248 °F)	± 1 K
Response time (63.2 % at 50 % FS flow)	250 ms
Resolution	0.006 K
Differential Temperature	
Accuracy 15-90 °C (59-194 °F)	0.3 K
Accuracy 0-120 °C (32-248 °F)	0.5 K
System conditions and environment	
Liquid types	Aqueous media compatible with wetted materials Kinematic viscosity less than or equal to 2 mm ² /s (cSt)
System temperature, operation	0-120 °C (32-248 °F)
System temperature, peak	-25 °C (-13 °F), non-freezing 120 °C (248 °F)
Ambient temperature, operation	-25 to +60 °C (-13 to +140 °F)
Ambient temperature, peak	-55 to +90 °C (-67 to +194 °F)
Humidity, relative	0-95 %, non-condensing
Maximum System Pressure	30 bar (435 psig)
Burst Pressure	40 bar (580 psig)
Maximum system pressure example	Max 16 bar (232 psig) at 100 °C (212 °F) Max 8 bar (116 psig) at 120 °C (248 °F)
Electrical data	
Power supply	5 VDC ($\pm 5 \%$), PELV Grounding of sensor supply required
Digital output signals	Grundfos open data protocol
Analogue output signals, only two signals possible (analogue variants are upon request)	0.5 - 4.1 for flow (zero at 0.28 V and 15 l/m at 3.5 V) and pressure (zero at 0.5 V) 0.5 - 4.1 V for temperature (zero at 0.5 V and 100 °C at 3.5 V)
Power consumption	Approximately 75 mW
Load impedance	> 47 k Ω
Materials	
Sensing element	Silicon-based MEMS
Sealing	EPDM O-ring or FKM O-ring
Housing	Composite (PPS, PA66)
Flow pipe	Stainless steel AISI 316 EN 1.4408
Insert	PPA 40 GF
Wetted materials	Corrosion-resistant coating, EPDM or FKM, PPS, PPA 40-GF, 1.4408
Environmental standards	
Enclosure class	IP44, cable connected
Temperature cycling	IEC 68-2-14
Vibration, non-destructive	20-2000 Hz, 10G, 4 h
Electromagnetic compatibility	EN 61326-1

MFS QT 4-40 l/min (1 - 10.6 gpm)



Fig. 112 MFS QT 4-40 l/min

TM05 4741 2512

Dimensions

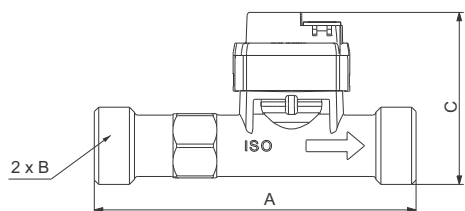

Fig. 113 Dimensions, MFS QT 4-40 l/min, with threads

TM05 4671 2512

	A	B	C
mm	110	ISO 228/1 - G3/4 A	58.8
in	4.33		2.31

Sensor output signals

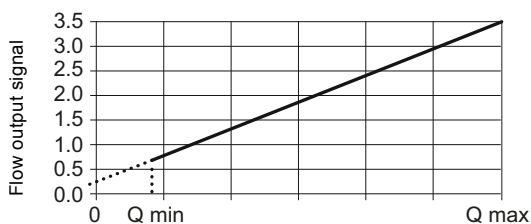

Fig. 114 Flow response in Analogue mode

TM07 2485 3618

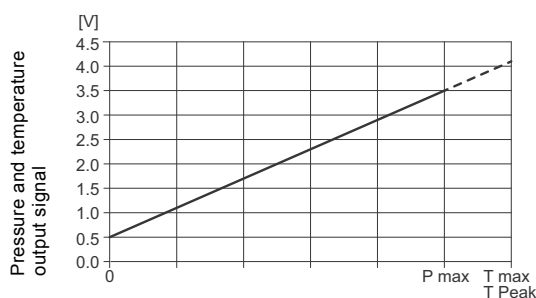

Fig. 115 Pressure and temperature response in Analogue mode

TM06 6560 1716

Specifications

Flow	
Measuring range	QT 4-40 l/min (1-10.6 gpm)
Accuracy ($\pm 1 \sigma$) in water 0-120 °C (32-248 °F)	$\pm 1 \%$ FS
Response time (63.2 %)	Less than 4 s
Resolution	max flow/16384 l/min or gpm
Pressure	
Measuring range	0-10 bar (0-145 psig)
Accuracy ($\pm 1 \sigma$), 15-90 °C (59-194 °F)	$\pm 2.0 \%$ FS
Accuracy ($\pm 1 \sigma$), 0-120 °C (32-248 °F)	$\pm 2.5 \%$ FS
Response time for sensor electronic	250 ms
Resolution	0.6 mbar (0.009 psig)
Temperature	
Measuring range	0-120 °C (32-248 °F)
Accuracy ($\pm 1 \sigma$), 15-90 °C (59-194 °F)	± 0.5 °C
Accuracy ($\pm 1 \sigma$), 0-120 °C (32-248 °F)	± 1 °C
Response time (63.2 % at 50 % FS flow)	250 ms
Resolution	0.006 K
Differential Temperature	
Accuracy 15-90 °C (59-194 °F)	0.3 K
Accuracy 0-120 °C (32-248 °F)	0.5 K
System conditions and environment	
Liquid types	Aqueous media compatible with wetted materials Kinematic viscosity less than or equal to 2 mm ² /s (cSt)
System temperature, operation	0-120 °C (32-248 °F)
System temperature, peak	-25 °C (-13 °F), non-freezing 120 °C (-248 °F)
Ambient temperature, operation	-25 to +60 °C (-13 to +140 °F)
Ambient temperature, peak	-55 to +90 °C (-67 to +194 °F)
Humidity, relative	0-95 %, non-condensing
Maximum System Pressure	30 bar (435 psig)
Burst Pressure	40 bar (580 psig)
Maximum system pressure example	Max 16 bar (232 psig) at 100 °C (212 °F) Max 8 bar (116 psig) at 120 °C (248 °F)
Electrical data	
Power supply	5 VDC ($\pm 5 \%$), PELV Grounding of sensor supply required
Digital output signals	Grundfos open data protocol
Analogue output signals, only two signals possible (analogue variants are upon request)	0.5 - 3.5 for flow (zero at 0.35 V) and pressure (zero at 0.5 V) 0.5 - 4.1 V for temperature (zero at 0.5 V and 100 °C at 3.5 V)
Power consumption	Approximately 75 mW
Load impedance	> 47 k Ω
Materials	
Sensing element	Silicon-based MEMS
Sealing	EPDM O-ring or FKM O-ring
Housing	Composite (PPS, PA66)
Flow pipe	Stainless steel AISI 316 EN 1.4408
Insert	PPA 40 GF
Wetted materials	Corrosion-resistant coating, EPDM or FKM, PPS, PPA 40-GF, 1.4408
Environmental standards	
Enclosure class	IP44, cable connected
Temperature cycling	IEC 68-2-14
Vibration, non-destructive	20-2000 Hz, 10G, 4 h
Electromagnetic compatibility	EN 61326-1

MFS QT 10-100 l/min (2.6 - 26 gpm)

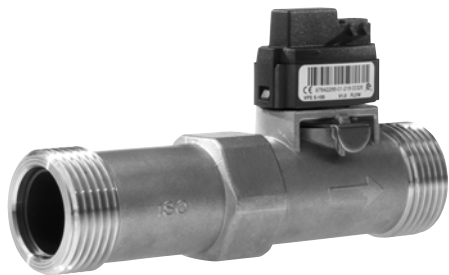

Fig. 116 MFS QT 10-100 l/min

TM05 4740 2512

Dimensions

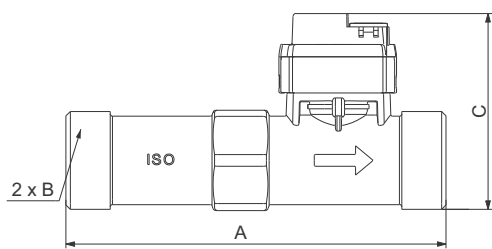

Fig. 117 Dimensions, MFS QT 10-100 l/min, with threads

TM05 4672 2512

	A	B	C
mm	129	ISO 228/1 - G1A	66.5
in	5.08		2.62

Sensor output signals

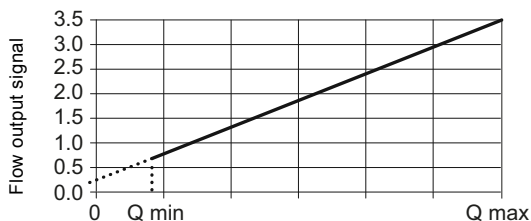

Fig. 118 Flow response in Analogue mode

TM07 2485 3618

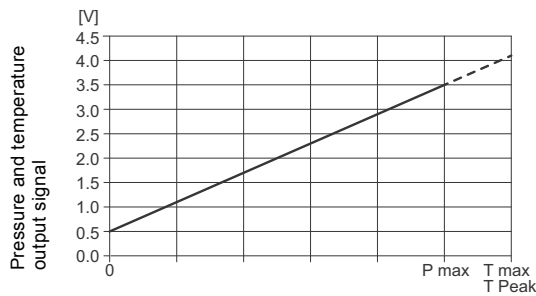

Fig. 119 Pressure and temperature response in Analogue mode

TM06 6560 1716

Specifications

Flow	
Measuring range	10-100 (2.6 -26 gpm)
Accuracy ($\pm 1 \sigma$) in water 0-120 °C (32-248 °F)	$\pm 1 \%$ FS
Response time (63.2 %)	Less than 4 s
Resolution	max flow/16384 l/min or gpm
Pressure	
Measuring range	0-10 bar (0-145 psig)
Accuracy ($\pm 1 \sigma$), 15-90 °C (59-194 °F)	$\pm 2.0 \%$ FS
Accuracy ($\pm 1 \sigma$), 0-120 °C (32-248 °F)	$\pm 2.5 \%$ FS
Response time for sensor electronic	250 ms
Resolution	0.6 mbar (0.009 psig)
Temperature	
Measuring range	0-120 °C (32-248 °F)
Accuracy ($\pm 1 \sigma$), 15-90 °C (59-194 °F)	± 0.5 K
Accuracy ($\pm 1 \sigma$), 0-120 °C (32-248 °F)	± 1 K
Response time (63.2 % at 50 % FS flow)	250 ms
Resolution	0.006 K
Differential Temperature	
Accuracy 15-90 °C (59-194 °F)	0.3 K
Accuracy 0-120 °C (32-248 °F)	0.5 K
System conditions and environment	
Liquid types	Aqueous media compatible with wetted materials Kinematic viscosity less than or equal to 2 mm ² /s (cSt)
System temperature, operation	0-120 °C (32-248 °F)
System temperature, peak	-25 °C (-13 °F), non-freezing 120 °C (-248 °F)
Ambient temperature, operation	-25 to +60 °C (-13 to +140 °F)
Ambient temperature, peak	-55 to +90 °C (-67 to +194 °F)
Humidity, relative	0-95 %, non-condensing
Maximum System Pressure	30 bar (435 psig)
Burst Pressure	40 bar (580 psig)
Maximum system pressure example	Max 16 bar (232 psig) at 100 °C (212 °F) Max 8 bar (116 psig) at 120 °C (248 °F)
Electrical data	
Power supply	5 VDC ($\pm 5 \%$), PELV Grounding of sensor supply required
Digital output signals	Grundfos open data protocol
Analog output signals, only two signals possible (analogue variants are upon request)	0.5 - 3.5 for flow (zero at 0.35 V) and pressure (zero at 0.5 V) 0.5 - 4.1 V for temperature (zero at 0.5 V and 100 °C at 3.5 V)
Power consumption	Approximately 75 mW
Load impedance	> 47 kΩ
Materials	
Sensing element	Silicon-based MEMS
Sealing	EPDM O-ring or FKM O-ring
Housing	Composite (PPS, PA66)
Flow pipe	Stainless steel AISI 316 EN 1.4408
Insert	PPA 40 GF
Wetted materials	Corrosion-resistant coating, EPDM or FKM, PPS, PPA 40-GF, 1.4408
Environmental standards	
Enclosure class	IP44, cable connected
Temperature cycling	IEC 68-2-14
Vibration, non-destructive	20-2000 Hz, 10G, 4 h
Electromagnetic compatibility	EN 61326-1

MFS QT 20-200 l/min (5.3 - 53 gpm)



Fig. 120 MFS QT 20-200 l/min

TM05 4739 2512

Dimensions

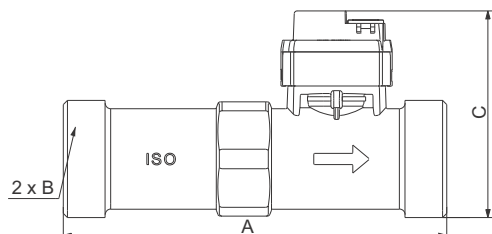

TM05 4673 2512

Fig. 121 Dimensions, MFS QT 20-200 l/min, with threads

Sensor output signals

	A	B	C
mm	137.5	ISO 228/1 - G1 1/4 A	74.1
in	5.41		2.92

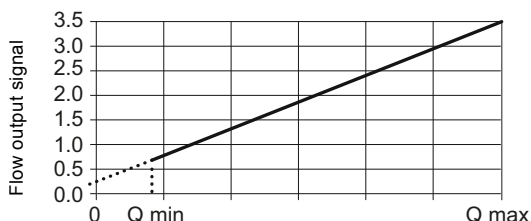

TM07 2485 3618

Fig. 122 Flow response in Analogue mode

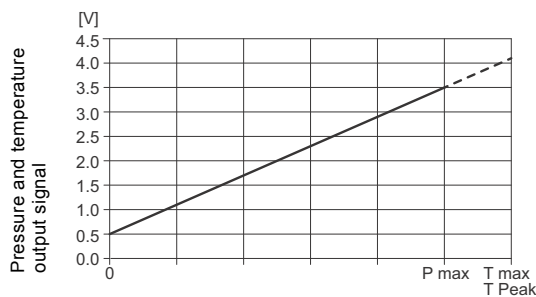

TM06 6560 1716

Fig. 123 Pressure and temperature response in Analogue mode

Specifications

Flow	
Measuring range	20-200 l/min (5.3 - 53 gpm)
Accuracy ($\pm 1 \sigma$) in water 0-120 °C (32-248 °F)	$\pm 1 \% FS$
Response time (63.2 %)	Less than 4 s
Resolution	max flow/16384 l/min or gpm
Pressure	
Measuring range	0-10 bar (0-145 psig)
Accuracy ($\pm 1 \sigma$), 15-90 °C (59-194 °F)	$\pm 2.0 \% FS$
Accuracy ($\pm 1 \sigma$), 0-120 °C (32-248 °F)	$\pm 2.5 \% FS$
Response time for sensor electronic	250 ms
Resolution	0.6 mbar (0.009 psig)
Temperature	
Measuring range	0-120 °C (32-248 °F)
Accuracy ($\pm 1 \sigma$), 15-90 °C (59-194 °F)	$\pm 0.5 K$
Accuracy ($\pm 1 \sigma$), 0-120 °C (32-248 °F)	$\pm 1 K$
Response time (63.2 % at 50 % FS flow)	250 ms
Resolution	0.006 K
Differential Temperature	
Accuracy 15-90 °C (59-194 °F)	0.3 K
Accuracy 0-120 °C (32-248 °F)	0.5 K
System conditions and environment	
Liquid types	Aqueous media compatible with wetted materials Kinematic viscosity less than or equal to 2 mm ² /s (cSt)
System temperature, operation	0-120 °C (32-248 °F)
System temperature, peak	-25 °C (-13 °F), non-freezing 120 °C (-248 °F)
Ambient temperature, operation	-25 to +60 °C (-13 to +140 °F)
Ambient temperature, peak	-55 to +90 °C (-67 to +194 °F)
Humidity, relative	0-95 %, non-condensing
Maximum System Pressure	30 bar (435 psig)
Burst Pressure	40 bar (580 psig)
Maximum system pressure example	Max 16 bar (232 psig) at 100 °C (212 °F) Max 8 bar (116 psig) at 120 °C (248 °F)
Electrical data	
Power supply	5 VDC ($\pm 5 \%$), PELV Grounding of sensor supply required
Digital output signals	Grundfos open data protocol
Analog output signals, only two signals possible (analogue variants are upon request)	0.5 - 3.5 for flow (zero at 0.35 V) and pressure (zero at 0.5 V) 0.5 - 4.1 V for temperature (zero at 0.5 V and 100 °C at 3.5 V)
Power consumption	Approximately 75 mW
Load impedance	> 47 kΩ
Materials	
Sensing element	Silicon-based MEMS
Sealing	EPDM O-ring or FKM O-ring
Housing	Composite (PPS, PA66)
Flow pipe	Stainless steel AISI 316, EN 1.4408
Insert	PPA 40 GF
Wetted materials	Corrosion-resistant coating, EPDM or FKM, PPS, PPA 40-GF, 1.4408
Environmental standards	
Enclosure class	IP44, cable connected
Temperature cycling	IEC 68-2-14
Vibration, non-destructive	20-2000 Hz, 10G, 4 h
Electromagnetic compatibility	EN 61326-1

6. Product range

VFI transmitters

Scope of delivery

- Flow pipe with transmitter
- flanges, only for flange versions
- fittings and union nuts for threaded versions
- 5 m (16.4 ft) cable with free cable end
- quick guide.

Complete product	Flow range	Flange size	O-ring		Connection type			Outside usage*
			EPDM	FKM	Cast iron flange	Stainless steel flange	Thread	
VFI--0.3-6m/1/C/M5.00-X/EG6/SG/30F/AC-1			•		•			•
VFI--0.3-6m/1/C/M5.00-X/VG6/SG/30F/AC-1				•	•			•
VFI--0.3-6m/1/C/M5.00-X/EG6/SS/30F/AC-1	0.3 - 6 m ³ /h	DN 25/32	•			•		•
VFI--0.3-6m/1/C/M5.00-X/VG6/SS/30F/AC-1	1.32 - 26.4 gpm	ANSI 1 1/4"		•		•		•
VFI--0.3-6m/1/C/M5.00-X/EG6/SS/07P/AC-1			•				•	•
VFI--0.3-6m/1/C/M5.00-X/VG6/SS/07P/AC-1				•			•	•
VFI-0.6-12m/1/C/M5.00-X/EG6/SG/30F/AC-1			•		•			•
VFI-0.6-12m/1/C/M5.00-X/VG6/SG/30F/AC-1				•	•			•
VFI-0.6-12m/1/C/M5.00-X/EG6/SS/30F/AC-1	0.6 - 12 m ³ /h	DN 25/32	•			•		•
VFI-0.6-12m/1/C/M5.00-X/VG6/SS/30F/AC-1	2.64 - 52.8 gpm	ANSI 1 1/4"		•		•		•
VFI-0.6-12m/1/C/M5.00-X/EG6/SS/07P/AC-1			•				•	•
VFI-0.6-12m/1/C/M5.00-X/VG6/SS/07P/AC-1				•			•	•
VFI-1.3-25m/1/C/M5.00-X/EG6/SG/30F/AC-1			•		•			•
VFI-1.3-25m/1/C/M5.00-X/VG6/SG/30F/AC-1				•	•			•
VFI-1.3-25m/1/C/M5.00-X/EG6/SS/30F/AC-1	1.3 - 25 m ³ /h	DN 25/32	•			•		•
VFI-1.3-25m/1/C/M5.00-X/VG6/SS/30F/AC-1	5.72 - 110.1 gpm	ANSI 1 1/4"		•		•		•
VFI-1.3-25m/1/C/M5.00-X/EG6/SS/09P/AC-1			•				•	•
VFI-1.3-25m/1/C/M5.00-X/VG6/SS/09P/AC-1				•			•	•
VFI---2-40m/1/C/M5.00-X/EG6/SG/31F/AC-1			•		•			•
VFI---2-40m/1/C/M5.00-X/VG6/SG/31F/AC-1	2-40 m ³ /h	DN 40		•	•			•
VFI---2-40m/1/C/M5.00-X/EG6/SS/31F/AC-1	8.81 - 176.1 gpm	ANSI 1 1/2"	•			•		•
VFI---2-40m/1/C/M5.00-X/VG6/SS/31F/AC-1				•		•		•
VFI-3.2-64m/1/C/M5.00-X/EG6/SG/32F/AC-1			•		•			•
VFI-3.2-64m/1/C/M5.00-X/VG6/SG/32F/AC-1	3.2 - 64 m ³ /h	DN 50		•	•			•
VFI-3.2-64m/1/C/M5.00-X/EG6/SS/32F/AC-1	14.09 - 281.8 gpm	ANSI 2"	•			•		•
VFI-3.2-64m/1/C/M5.00-X/VG6/SS/32F/AC-1				•		•		•
VFI/5.2-104m/1/C/M5.00-X/EG6/SG/33F/AC-1			•		•			•
VFI/5.2-104m/1/C/M5.00-X/VG6/SG/33F/AC-1	5.2 - 104 m ³ /h	DN 65		•	•			•
VFI/5.2-104m/1/C/M5.00-X/EG6/SS/33F/AC-1	22.89 - 457.9 gpm	ANSI 2 1/2"	•			•		•
VFI/5.2-104m/1/C/M5.00-X/VG6/SS/33F/AC-1				•		•		•
VFI--8-160m/1/C/M5.00-X/EG6/SG/35F/AC-1			•		•			•
VFI--8-160m/1/C/M5.00-X/VG6/SG/35F/AC-1	8-160 m ³ /h	DN 80		•	•			•
VFI--8-160m/1/C/M5.00-X/EG6/SS/35F/AC-1	35.22 - 704.5 gpm	ANSI 3"	•			•		•
VFI--8-160m/1/C/M5.00-X/VG6/SS/35F/AC-1				•		•		•
VFI-12-240m/1/C/M5.00-X/EG6/SG/42F/AC-1			•		•			•
VFI-12-240m/1/C/M5.00-X/VG6/SG/42F/AC-1	12-240 m ³ /h	DN 100		•	•			•
VFI-12-240m/1/C/M5.00-X/EG6/SS/42F/AC-1	52.83 - 1057 gpm	ANSI 4"	•			•		•
VFI-12-240m/1/C/M5.00-X/VG6/SS/42F/AC-1				•		•		•

* Outside usage only with cable connected.

VFS and VFS QT sensors

Scope of delivery

- Flow pipe with sensor
- composite flow pipe with brass adapter (only VFS)
- stainless steel flow pipe (only VFS QT)
- quick guide.

Complete product	Flow range	O-ring		Flow pipe		Connection type	
		EPDM	FKM	Composite	Stainless steel	Brass adapter	Stainless steel
VFS/---1-20I/1/D/S-----/EG4/CB/03P/SW-1	1.3 - 20 l/min	•		•		ISO 228-G1/2 A	
VFS/--1-20I/1/D/S-----/VG4/CB/03P/SW-1				•	•	ISO 228-G1/2 A	
VFS/---2-40I/1/D/S-----/EG4/CB/04P/SW-1	2-40 l/min	•		•		ISO 228-G3/4 A	
VFS/--2-40I/1/D/S-----/VG4/CB/04P/SW-1				•	•	ISO 228-G3/4 A	
VFS/--5-100I/1/D/S-----/EG4/CB/04B/SW-1	5-100 l/min	•		•		ISO 7/1 R 3/4	
VFS/--5-100I/1/D/S-----/VG4/CB/04B/SW-1				•	•	ISO 7/1 R 3/4	
VFS/-10-200I/1/D/S-----/EG4/CB/05B/SW-1	10-200 l/min	•		•		ISO 7/1 R 1	
VFS/-10-200I/1/D/S-----/VG4/CB/05B/SW-1				•	•	ISO 7/1 R 1	
VFS/-20-400I/1/D/S-----/EG4/CB/07B/SD-1	20-400 l/min	•		•		ISO 7/1 R 1 1/4	
VFS/-20-400I/1/D/S-----/VG4/CB/07B/SD-1				•	•	ISO 7/1 R 1 1/4	
VFS/---1-18I/1/D/S-----/EG4/Q-/04P/SW-1	1-18 l/min	•			•	ISO 228/1-G3/4 A	
VFS/--1-18I/1/D/S-----/VG4/Q-/04P/SW-1				•		•	ISO 228/1-G3/4 A
VFS/---2-40I/1/D/S-----/EG4/Q-/04P/SW-1	2-40 l/min	•			•	ISO 228/1-G3/4 A	
VFS/--2-40I/1/D/S-----/VG4/Q-/04P/SW-1				•		•	ISO 228/1-G3/4 A
VFS/--5-100I/1/D/S-----/EG4/Q-/05P/SW-1	5-100 l/min	•			•	ISO 228/1-G1 A	
VFS/--5-100I/1/D/S-----/VG4/Q-/05P/SW-1				•		•	ISO 228/1-G1 A
VFS/-10-200I/1/D/S-----/EG4/Q-/07P/SW-1	10-200 l/min	•			•	ISO 228/1-G1 1/4 A	
VFS/-10-200I/1/D/S-----/VG4/Q-/07P/SW-1				•		•	ISO 228/1-G1 1/4 A

7. Accessories

Sensor interface, converter unit

The SI Converter sensor interface from Grundfos Direct Sensors™ is an external power supply, signal amplifier and signal converter for Grundfos sensors, standard variants (MFS, VFS, RPS and DPS).

SI Converter has built-in precision resistors enabling the sensor to give 4-20 mA, 1-5 V and 2-10 V output signals.

SI Converter is designed for applications where sensors from the standard product range are used. The sensor interface delivers a 4-20 mA input signal to external controllers.



TM04 4882 2209

Fig. 124 Sensor interface, SI Converter

Specifications

- Voltage range: 115-230 VAC ± 10 % or 24 VDC
- frequency: 50-60 Hz
- power consumption: Maximum 2.5 W
- ambient temperature: -20 to +50 °C (-4 to +122 °F)
- enclosure class: IP20.

Part

Sensor interface, SI Converter, IP20

M12 cable

The 4-wire screened cable with M12 connector in the sensor end and open end in the equipment end is available as an accessory. Use the cable for the industrial sensor series such as RPI, DPI II and VFI.

	Description	Length
	Cable, industry M2.000X	2 m (6.6 ft)
	Cable, industry M5.000X	5 m (16.4 ft)

Snap-on cable

Cable with snap-on connection in sensor end and different variants in the equipment end, such as open end, ferrules and various types of connectors.

Use the cable for the standard sensor series such as MFS, VFS, RPS and DPS.

The cable is available in various lengths, mainly 1.2 m and 2.9 m.

	Description	Length [mm]
	Ferrules, 1.2 m	1200
	Ferrules, 2.9 m	2900

8. Appendix

Pressure drop curves

VFI sensor

Selection of flow sensor to minimise pressure drop at 1 cSt

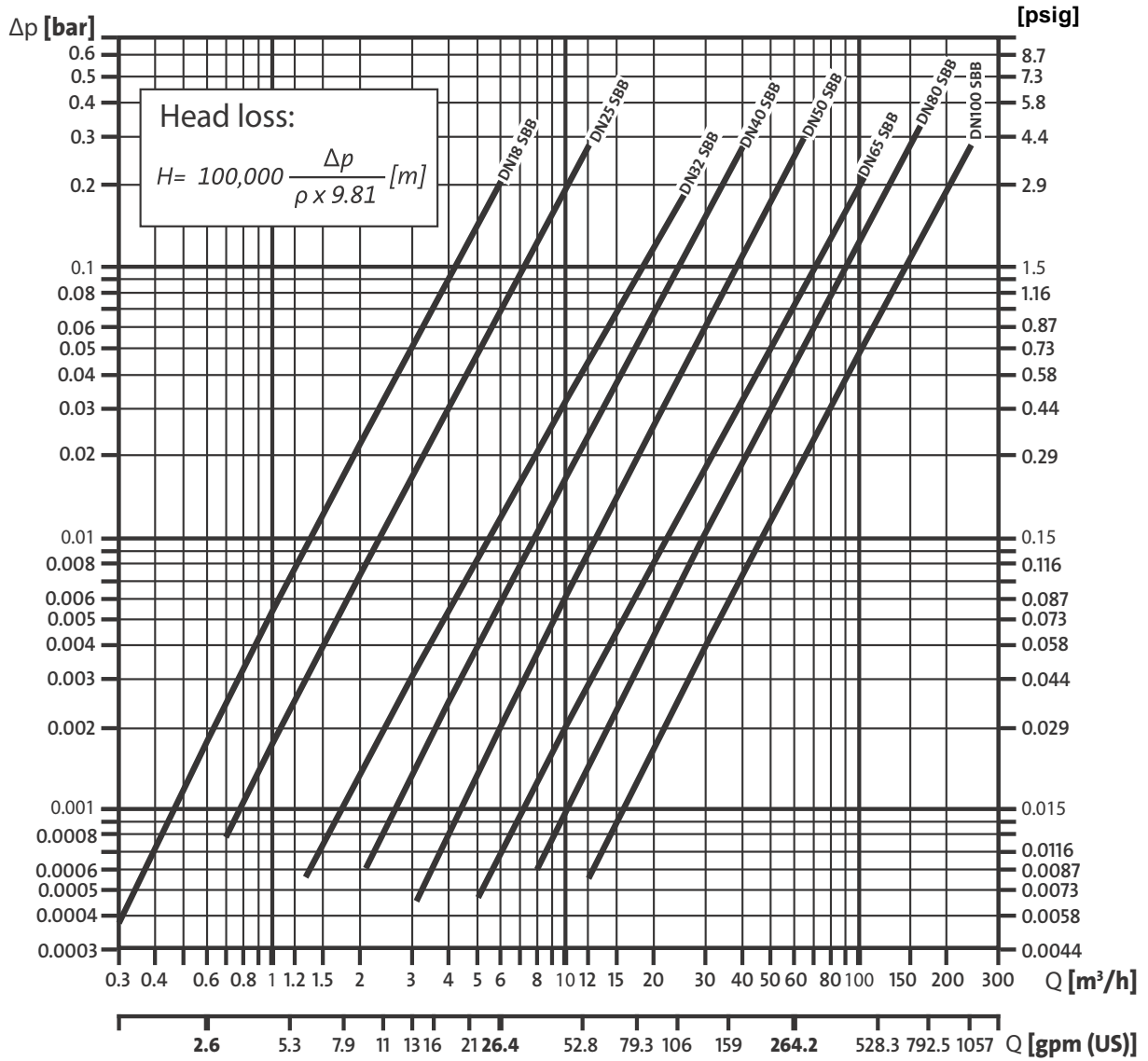

TM06 6536 1716

VFS sensor

Selection of flow sensor to minimise pressure drop at 1 cSt

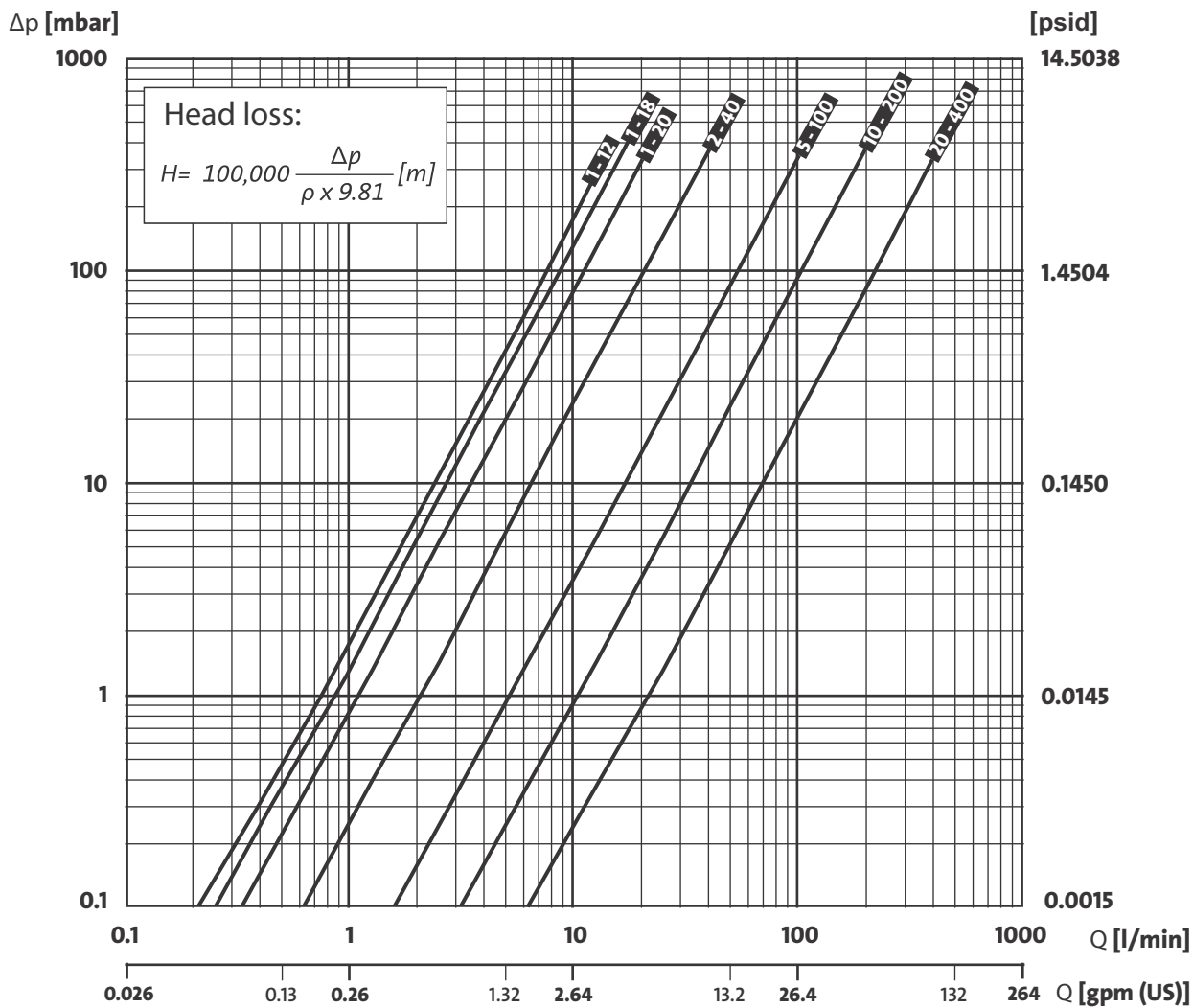

TM06 6537 4118

Installation of the VFI sensor

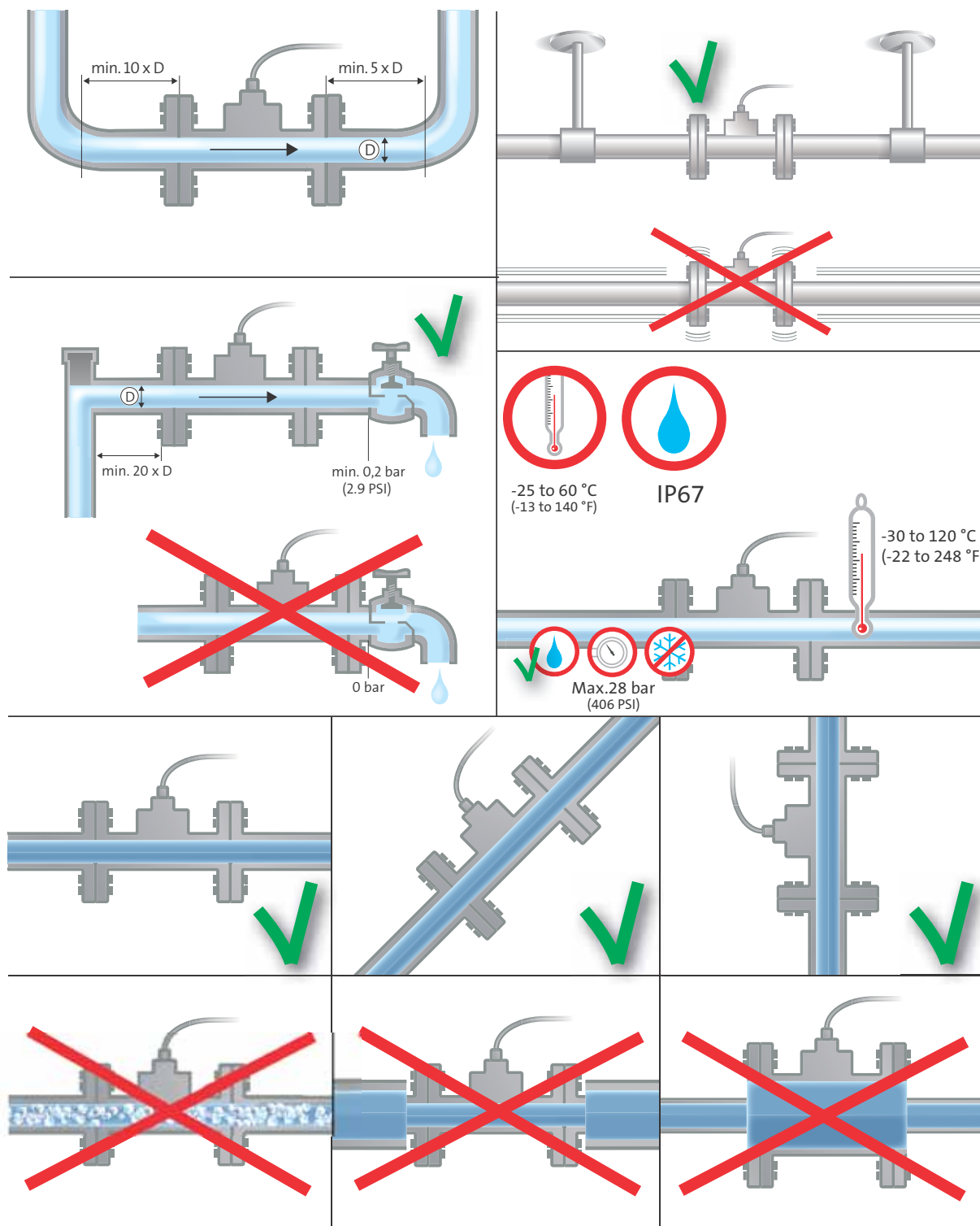

TM05 2306 2118

Intended use for pressurised systems

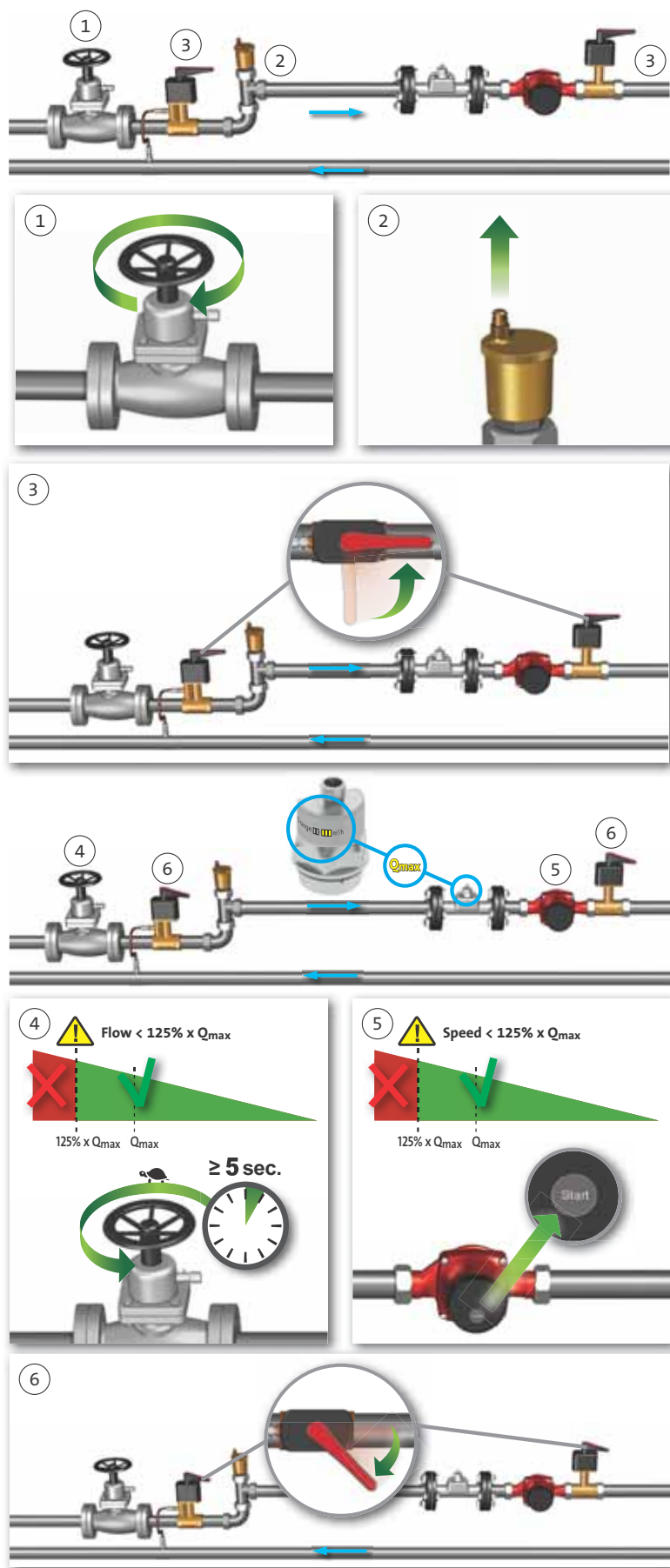

TM07 1885 2018

9. Grundfos Product Center

Online search and sizing tool to help you make the right choice.

<http://product-selection.grundfos.com>



SIZING enables you to size a pump based on entered data and selection choices.

REPLACEMENT enables you to find a replacement product. Search results will include information on

- the lowest purchase price
- the lowest energy consumption
- the lowest total life cycle cost.

The screenshot shows the Grundfos Product Center website. At the top, there is a navigation bar with the logo and 'PRODUCT CENTER'. Below it, a menu includes 'HOME', 'FIND PRODUCT', 'COMPARE', 'YOUR PROJECTS', 'SAVED ITEMS', and 'HELP'. The main content area is titled 'FIND PRODUCTS AND SOLUTIONS' and features a search bar with a 'SEARCH' button. Below the search bar are four main navigation buttons: 'SIZING' (Enter pump sizing), 'CATALOGUE' (Products and services), 'REPLACEMENT' (Replace an old pump with a new), and 'LIQUIDS' (Find pump by liquid). The 'QUICK SIZING' tool is visible, with fields for 'Enter duty point' (Flow (Q)* and Head (H)*) and 'Select what to size by' (Size by application, Size by pump design, Size by pump family). A 'START SIZING' button is also present.

CATALOGUE gives you access to the Grundfos product catalogue.

LIQUIDS enables you to find pumps and sensors designed for aqueous media or other special liquids.

All the information you need in one place

Performance curves, technical specifications, pictures, dimensional drawings, motor curves, wiring diagrams, spare parts, service kits, 3D drawings, documents, system parts. The Product Center displays any recent and saved items - including complete projects - right on the main page.

Downloads

On the product pages, you can download installation and operating instructions, data booklets, service instructions, etc. in PDF format. For aqueous media below 2 µS/cm contact your local Grundfos sensor representative.

