

Normpumpen
Standardized Pumps
Pompes normalisées
Pompe normalizzate
Standaardpompen
Bombas estandarizadas

Blockpumpen
Close-coupled Pumps
Pompes monobloc
Pompe monoblocco
Blokpompen
Bombas monobloc

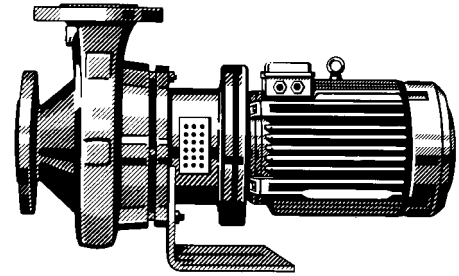
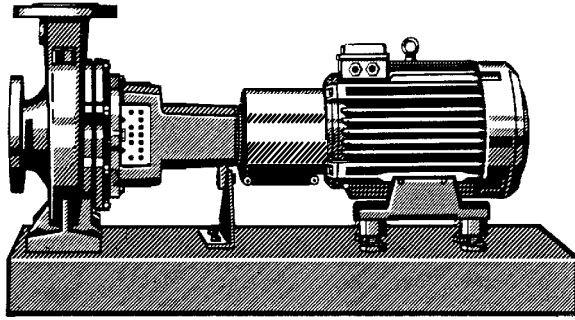

50 Hz 2900, 1450 1/min⁻¹

Baugröße	n = 2900 min ⁻¹			n = 1450 min ⁻¹		
	Etanorm	Etabloc	Seite Page Page Pagina Bladzijde Pagina	Etanorm	Etabloc	Seite Page Page Pagina Bladzijde Pagina
25-20	-	x	8	-	x	37
32-23	-	x	9	-	-	--
32-125.1	x	x	10	x	x	38
32-160.1	x	x	11	x	x	39
32-200.1	x	x	12	x	x	40
32-250.1	x	x	13	x	x	41
32-125	x	x	14	x	x	42
32-160	x	x	15	x	x	43
32-200	x	x	16	x	x	44
32-250	x	x	17	x	x	45
40-125	x	x	18	x	x	46
40-160	x	x	19	x	x	47
40-200	x	x	20	x	x	48
40-250	x	x	21	x	x	49
40-315	-	-	--	x	x	50
50-125	x	x	22	x	x	51
50-160	x	x	23	x	x	52
50-200	x	x	24	x	x	53
50-250	x	x	25	x	x	54
50-315	-	-	--	x	x	55
65-125	x	x	26	x	x	56
65-160	x	x	27	x	x	57
65-200	x	x	28	x	x	58
65-250	x	x	29	x	x	59
65-315	-	-	--	x	x	60

Baugröße	n = 2900 min ⁻¹			n = 1450 min ⁻¹		
	Etanorm	Etabloc	Seite Page Page Pagina Bladzijde Pagina	Etanorm	Etabloc	Seite Page Page Pagina Bladzijde Pagina
80-160	x	x	30	x	x	61
80-200	x	x	31	x	x	62
80-250	x	x	32	x	x	63
80-315	-	-	--	x	x	64
80-400	-	-	--	x	x	65
100-160	x	x	33	x	x	66
100-200	x	x	34	x	x	67
100-250	x	-	35	x	x	68
100-315	-	-	--	x	x	69
100-400	-	-	--	x	x	70
125-200	x	-	36	x	x	71
125-250	-	-	--	x	x	72
125-315	-	-	--	x	x	73
125-400	-	-	--	x	x	74
150-200	-	-	--	x	x	75
150-250	-	-	--	x	x	76
150-315	-	-	--	x	x	77
150-400	-	-	--	x	x	78





Die in den Kennlinienblättern angegebenen NPSH-Werte sind Minimalwerte, die der Kavitationsgrenze entsprechen; sie gelten für entgastes Wasser.

Aus Sicherheitsgründen sind daher die Kurvenwerte für die Anwendung um mindestens 0,5 m zu erhöhen.

Garantien der Meßwerte in den Kennlinien nach DIN 1944/III. Die Förderhöhen und Leistungsangaben gelten für Fördermedien mit der Dichte $\rho = 1,0 \text{ kg/dm}^3$ und eine kinematische Viskosität ν bis $20 \text{ mm}^2/\text{s}$.

Ist die Dichte $\rho = 1,0$, dann muß die Leistungsangabe mit ρ multipliziert werden.

Achtung!

Bei Werkstoffausführung 1.4408 sind die in den Kennlinien angegebenen Wirkungsgradprozente jeweils um 2%-Punkte zu reduzieren.

Die Motornennleistungen gelten bei einer Umgebungstemperatur bis $40 \text{ }^\circ\text{C}$, einer Aufstellungshöhe bis 1000 m über dem Meeresspiegel und Spannungen bis 2,2 kW: 220-240 V/380-420 V
ab 3,0 kW: 380-420 V/660-725 V.

The NPSH values given in the performance curve sheets are minimum values which correspond to the inception of cavitation, they apply to degassed water.

For reasons of safety the curve values must, therefore, be increased by at least 0.5 m for application.

For guarantees of measured values see performance curves to DIN 1944/III.

The total heads and the performance characteristics refer to mediums compressed with $\rho = 1.0 \text{ kg/dm}^3$ and a kinematic viscosity ν up to $20 \text{ mm}^2/\text{s}$.

If the density $\rho = 1.0$, the performance characteristics are to be multiplied by ρ .

Caution!

In case of material construction 1.4408 the efficiency percentages stated in the performance curves have to be reduced by 2%, each.

The motor ratings are valid for an ambient temperature of max. $40 \text{ }^\circ\text{C}$, for places of installation situated max. 1000 m above sea level and frequencies

up to 2.2 kW: 220-240 V/380-420 V
from 3.0 kW: 380-420 V/660-725 V.

Les valeurs du NPSH indiquées par les feuilles de courbes sont des valeurs minimales qui correspondent à la limite de cavitation; elles concernent le pompage d'eau dégazée.

Pour des raisons de sécurité, les valeurs de la courbe sont à augmenter d'au moins 0,5 m pour l'application.

Valeurs mesurées des courbes garanties selon DIN 1944/III.

Les caractéristiques de la pompe indiquées sont valables pour un fluide pompé d'une densité égale à 1 kg/dm^3 , et pour une viscosité cinématique n'excédant pas $20 \text{ mm}^2/\text{s}$.

Si la densité du fluide pompé a une valeur différente de 1,0, multiplier par cette valeur les caractéristiques indiquées.

Attention!

Pour l'exécution en 1.4408 les pourcentages du rendement indiqués dans les courbes caractéristiques sont à réduire de 2%.

Les puissances nominales du moteur sont valables pour une température ambiante jusqu'à $40 \text{ }^\circ\text{C}$, pour une hauteur d'installation jusqu'à 1000 m au-dessus du niveau de la mer et fréquences

jusqu'à 2,2 kW: 220-240 V/380-420 V
de 3,0 kW: 380-420 V/660-725 V.

I valori di NPSH indicati nei fogli delle curve sono valori minimi, che corrispondono al limite della cavitazione; essi valgono per acqua degasata.

Per motivi di sicurezza i valori delle curve devono quindi venir aumentati di 0,5 m per l'impiego pratico.

I valori misurati delle curve sono garantiti secondo DIN 1944/III. Le prevalenze e le potenze indicate valgono per liquidi con densità $\rho = 1,0 \text{ kg/dm}^3$ ed una viscosità cinematica ν sino a $20 \text{ mm}^2/\text{sec}$. al massimo.

Se la densità $\rho = 1,0$, la potenza indicata deve venir moltiplicata per ρ .

Attenzione!

Con l'esecuzione in 1.4408 i rendimenti percentuali indicati nelle curve caratteristiche devono venir ridotti di 2 punti percentuali.

Le potenze nominali dei motori valgono con una temperatura ambiente fino a $40 \text{ }^\circ\text{C}$, una installazione sino alla quota di 1000 m sul livello del mare e tensioni fino a 2,2 kW: 220-240 V/380-420 V
da 3,0 kW: 380-420 V/660-725 V.

De in de grafieken aangegeven NPSH-waarden zijn minimale waarden die overeenkomen met de kavitatiegrenzen; zij gelden voor niet gashoudend water.

Uit veiligheidsoverwegingen dienen de grafiekwaarden voor de toepassing met tenminste 0,5 m verhoogt te worden.

De meetwaarden in de grafieken voldoen aan DIN 1944/III.

De obvoerhoogten en afgegeven vermogens gelden voor media met een dichtheid $\rho = 1,0 \text{ kg/dm}^3$ en een kinematische viscositeit ν tot max. $20 \text{ mm}^2/\text{s}$.

Als de dichtheid $\rho = 1,0$, dan dient het afgegeven vermogen met ρ vermenigvuldigt te worden.

Let op!

Bij materiaaluitvoering 1.4408 dienende in de grafiek aangegeven rendementpercentages telkens met 2% gereduceerd te worden.

De motorkapaciteiten gelden voor omgevingstemperaturen tot $40 \text{ }^\circ\text{C}$, opstellingshoogten tot 1000 m boven zeeniveau en frequenties

tot 2,2 kW: 220-240 V/380-420 V
van af 3,0 kW: 380-420 V/660-725 V.

Los valores NPSH indicados en las hojas de curvas características son valores mínimos que corresponden al límite de cavitación y rigen para agua desgasificada.

En la práctica, los valores de las curvas deben aumentarse por lo menos 0,5 m por razones de seguridad.

Garantías de los valores de medición en las curvas características según DIN 1944/III.

Las alturas manométricas y las indicaciones sobre potencias requeridas valen para líquidos de elevación con densidad $\rho = 1,0 \text{ kg/dm}^3$ y una viscosidad cinemática hasta un máximo de $20 \text{ mm}^2/\text{s}$.

Si la densidad $\rho = 1,0$ debe multiplicarse la potencia indicada por ρ .

Atención!

En la ejecución 1.4408, los porcentajes del rendimiento indicados en las curvas características deben reducirse en un 2%.

Las potencias nominales de los motores son válidas para una temperatura ambiente de hasta $40 \text{ }^\circ\text{C}$, una altura de instalación de hasta 1000 m sobre el nivel del mar y tensiones hasta 2,2 kW: 220-240 V/380-420 V
desde 3,0 kW: 380-420 V/660-725 V.



Etanorm

n = 29001/min

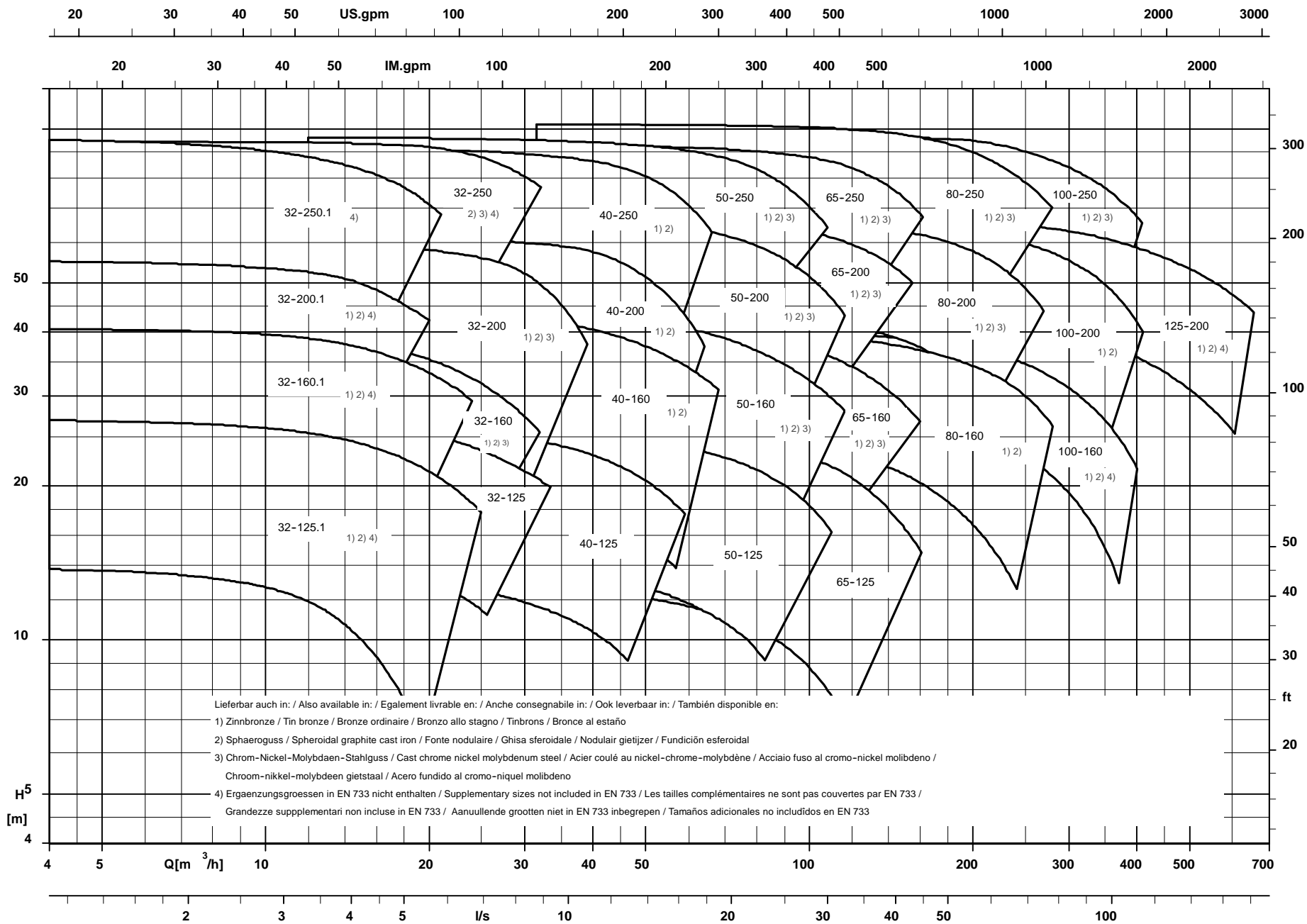

1211.452/7

Etanorm/Etabloc

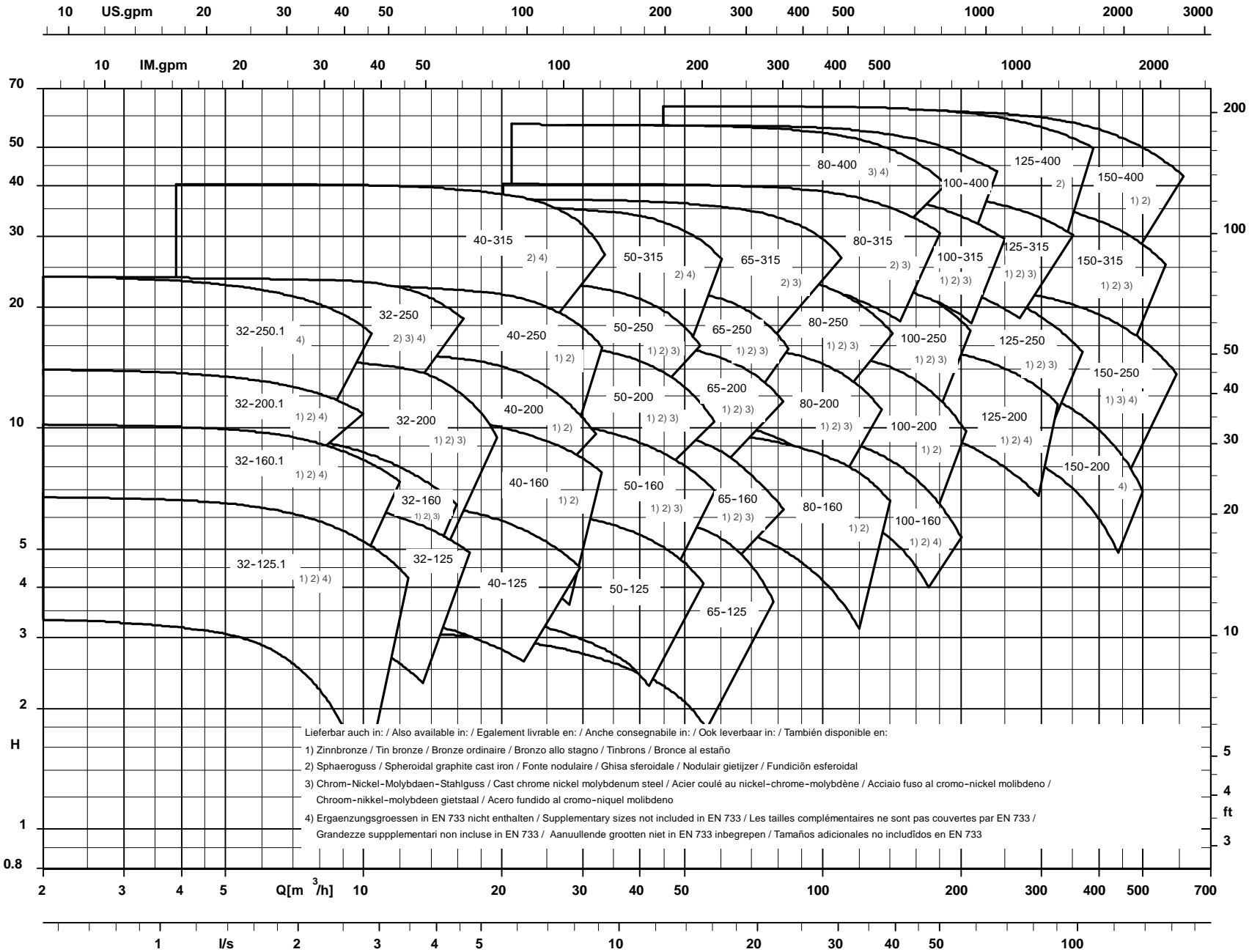

1211.454/8

Etanorm
n = 1450 1/min



Etanorm/Etabloc

Q

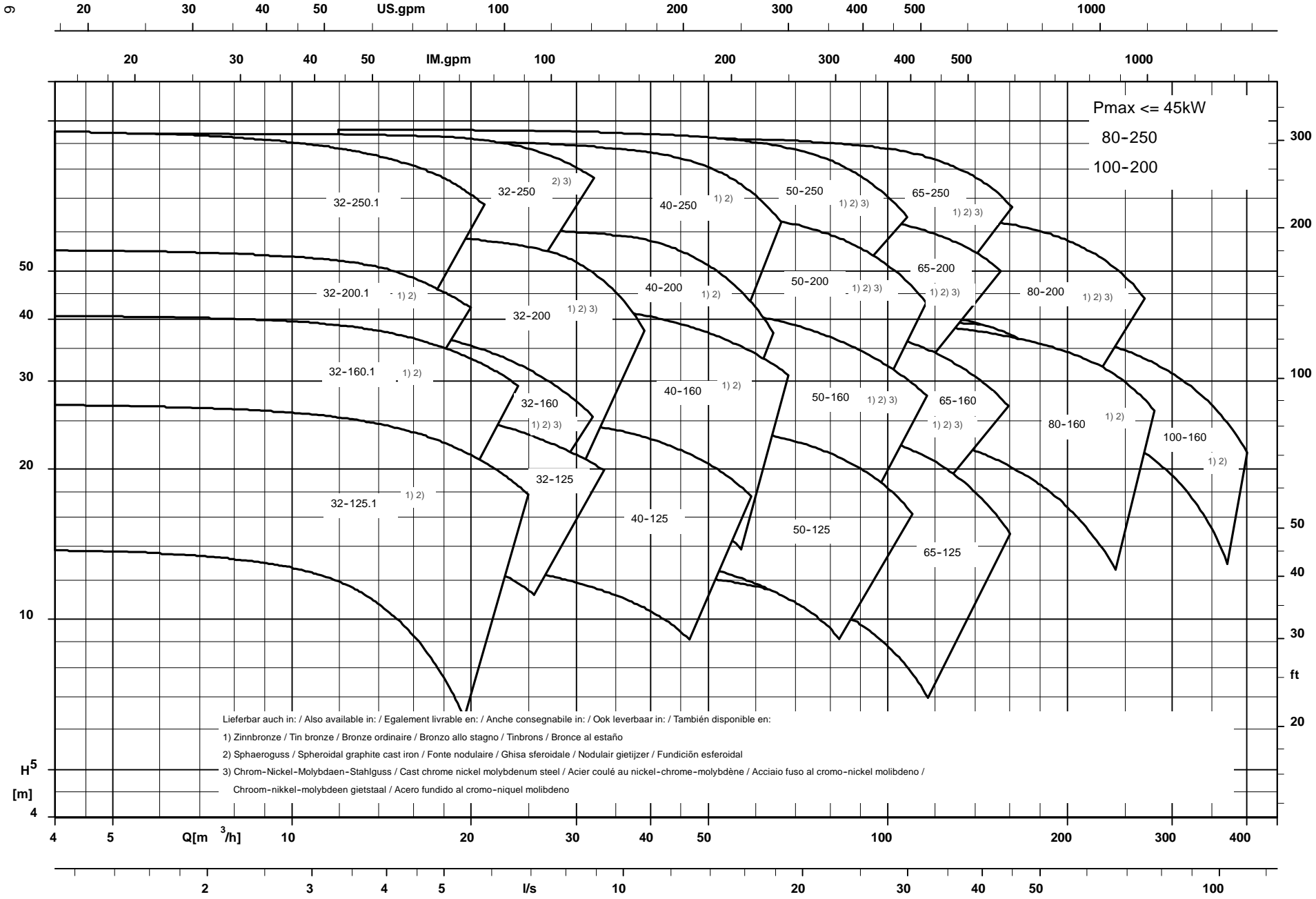

Lieferbar auch in: / Also available in: / Egalement livrable en: / Anche consegnabile in: / Ook leverbaar in: / También disponible en:

- 1) Zinnbronze / Tin bronze / Bronze ordinaire / Bronzo allo stagno / Tinbrons / Bronce al estaño
- 2) Sphaeroguss / Spheroidal graphite cast iron / Fonte nodulaire / Ghisa sferoidale / Nodulair gietijzer / Fundición esteroidal
- 3) Chrom-Nickel-Molybdaen-Stahlguss / Cast chrome nickel molybdenum steel / Acier coulé au nickel-chrome-molybdène / Acciaio fuso al cromo-nickel molibdeno / Chrom-nikkel-molybdeen gietstaal / Acero fundido al cromo-niquel molibdeno

H⁵
[m]
4

1167.4052/7

Etabloc
n ≈ 2900 1/min



Etanorm/Etabloc



Etabloc
n ≈ 1450 1/min

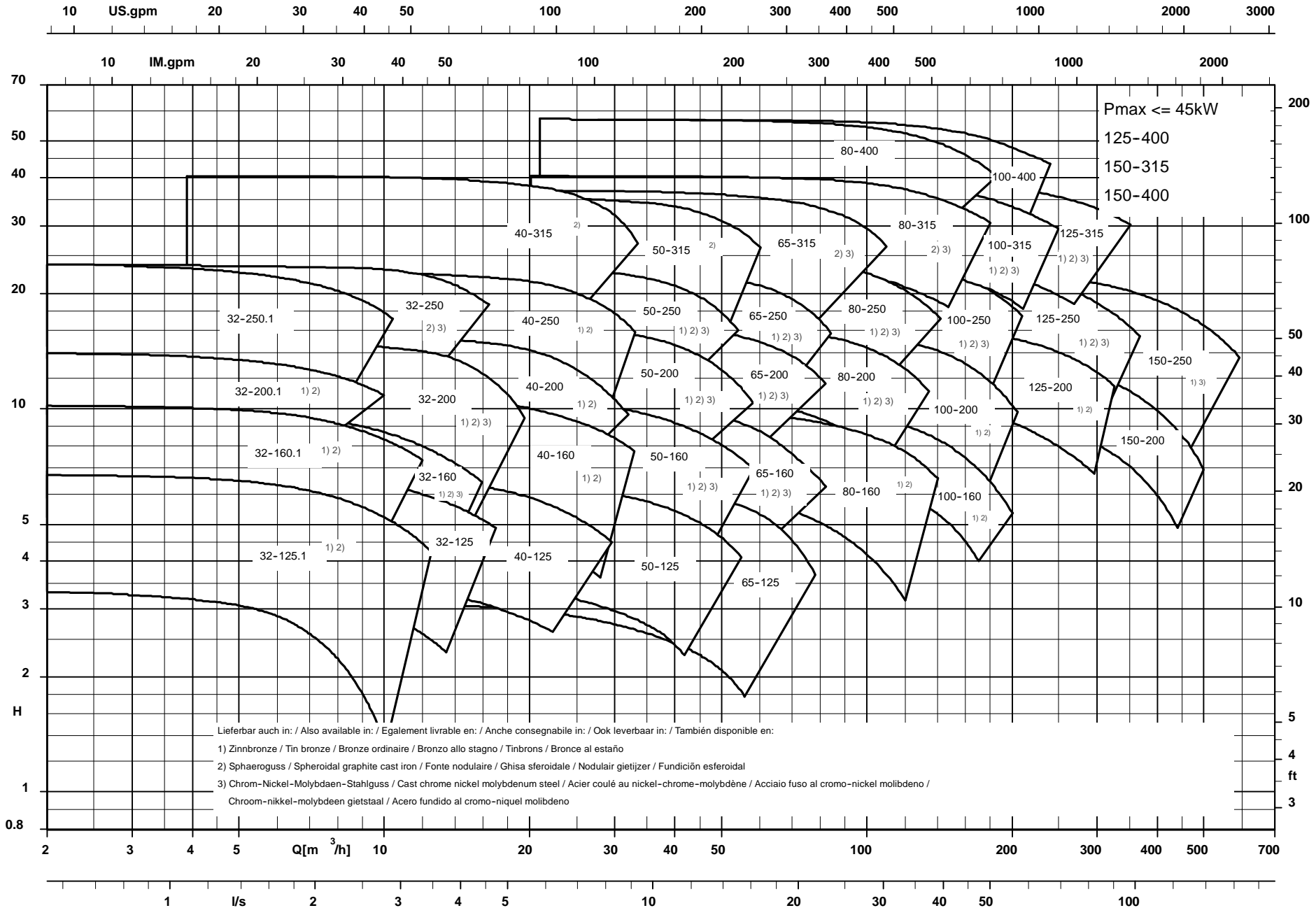

1167.4054/7

Baureihe-Größe Type-Size Modèle	Tipo Serie Tipo	Nennzahl Nom. speed Vitesse nom.	Velocità di rotazione nom. Nominaal toerental Revoluciones nom.	Lauf-ø Impeller Dia. Diamètre de roue	ø Girante ø Waaier ø Rodete	 <p>KSB Aktiengesellschaft Unternehmensbereich Pumpen Industrie- und Wassertechnik Postfach 1725, 67225 Frankenthal Joh.-Klein-Str. 9, 67227 Frankenthal</p>
Etabloc 25-20		2900 1/min				
Projekt Project Projet	Progetto Projekt Proyecto	Angebots-Nr. Project No. No. de l'offre	Offerta-No. Offertenr. Offerta-No.	Pos.-Nr. Item No. No. de pos.	Pos.-Nr. Positiennr. Pos.-Nr.	

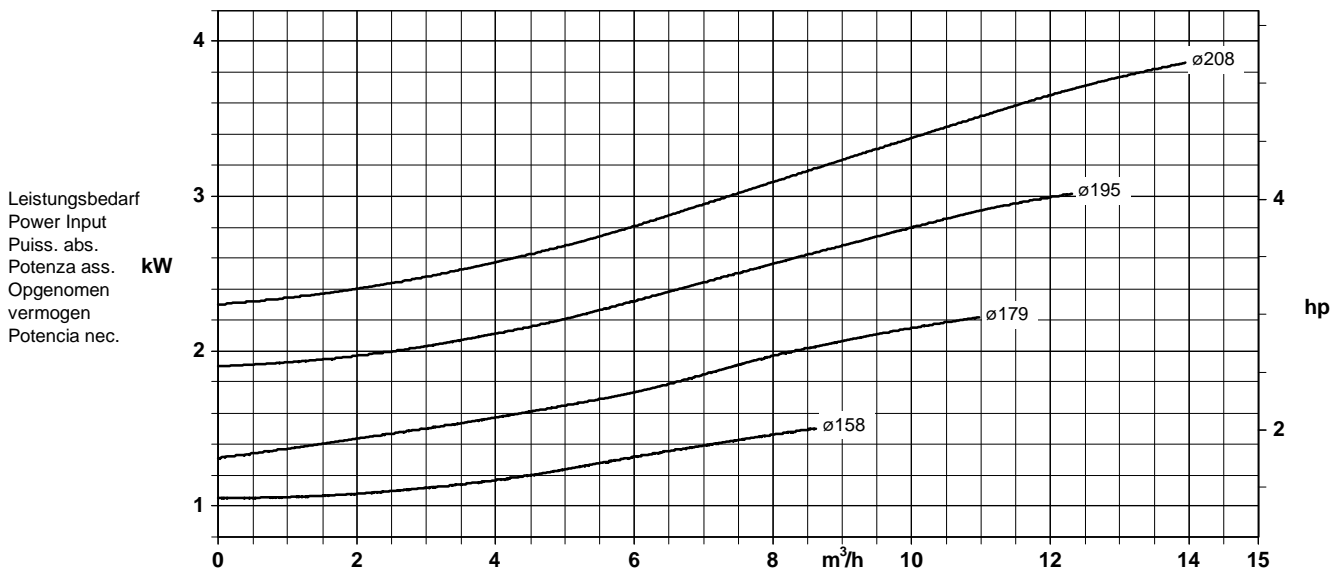
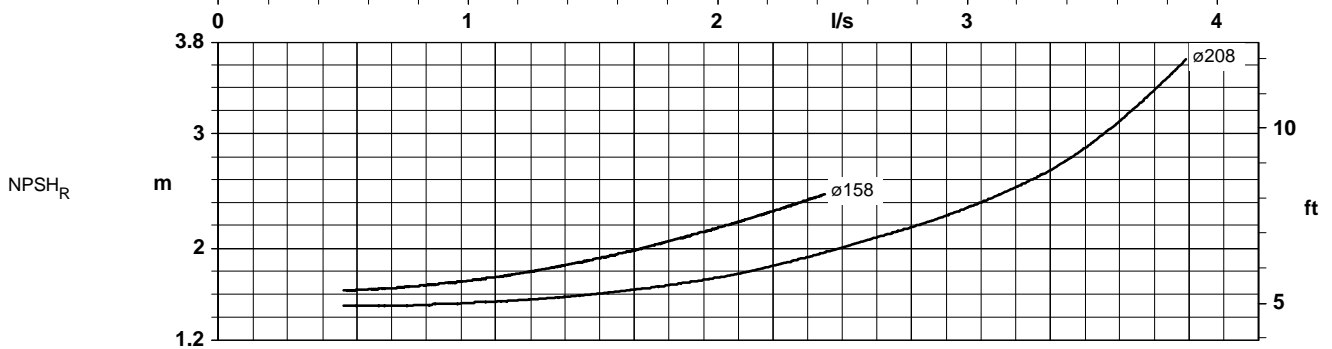
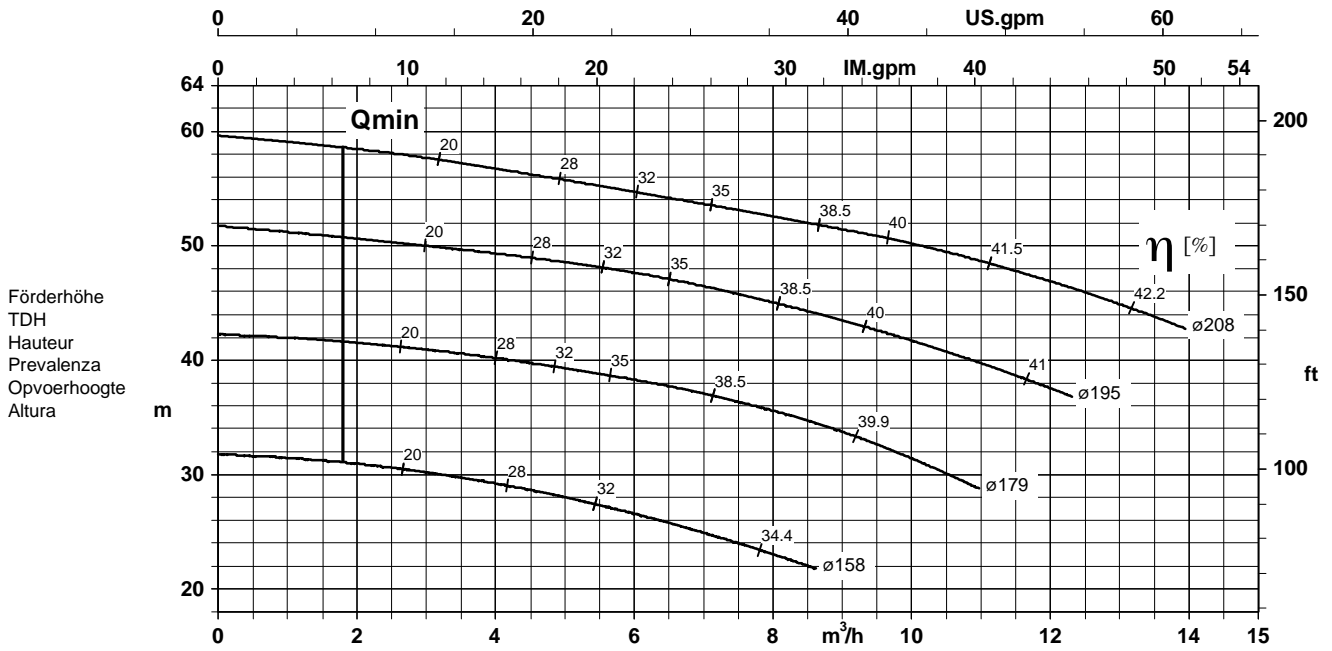

Förderstrom/Flow/Débit/Portata/Kapazität/Caudal

K1167:101/1

Baureihe-Größe Type-Size Modèle	Tipo Serie Tipo	Nenn Drehzahl Nom. speed Vitesse nom.	Velocità di rotazione nom. Nominaal toerental Revoluciones nom.	Lauf rad- ϕ Impeller Dia. Diamètre de roue	ϕ Girante ϕ Waaier ϕ Rodete	 KSB Aktiengesellschaft Unternehmensbereich Pumpen Industrie- und Wassertechnik Postfach 1725, 67225 Frankenthal Joh.-Klein-Str. 9, 67227 Frankenthal
Etabloc 32-23		2900 1/min				
Projekt Project Projet	Progetto Projekt Proyecto	Angebots-Nr. Project No. No. de l'offre	Offerta-No. Offertenr. Offerta-No.	Pos.-Nr. Item No. No. de pos.	Pos.-Nr. Positiën. Pos.-Nr.	

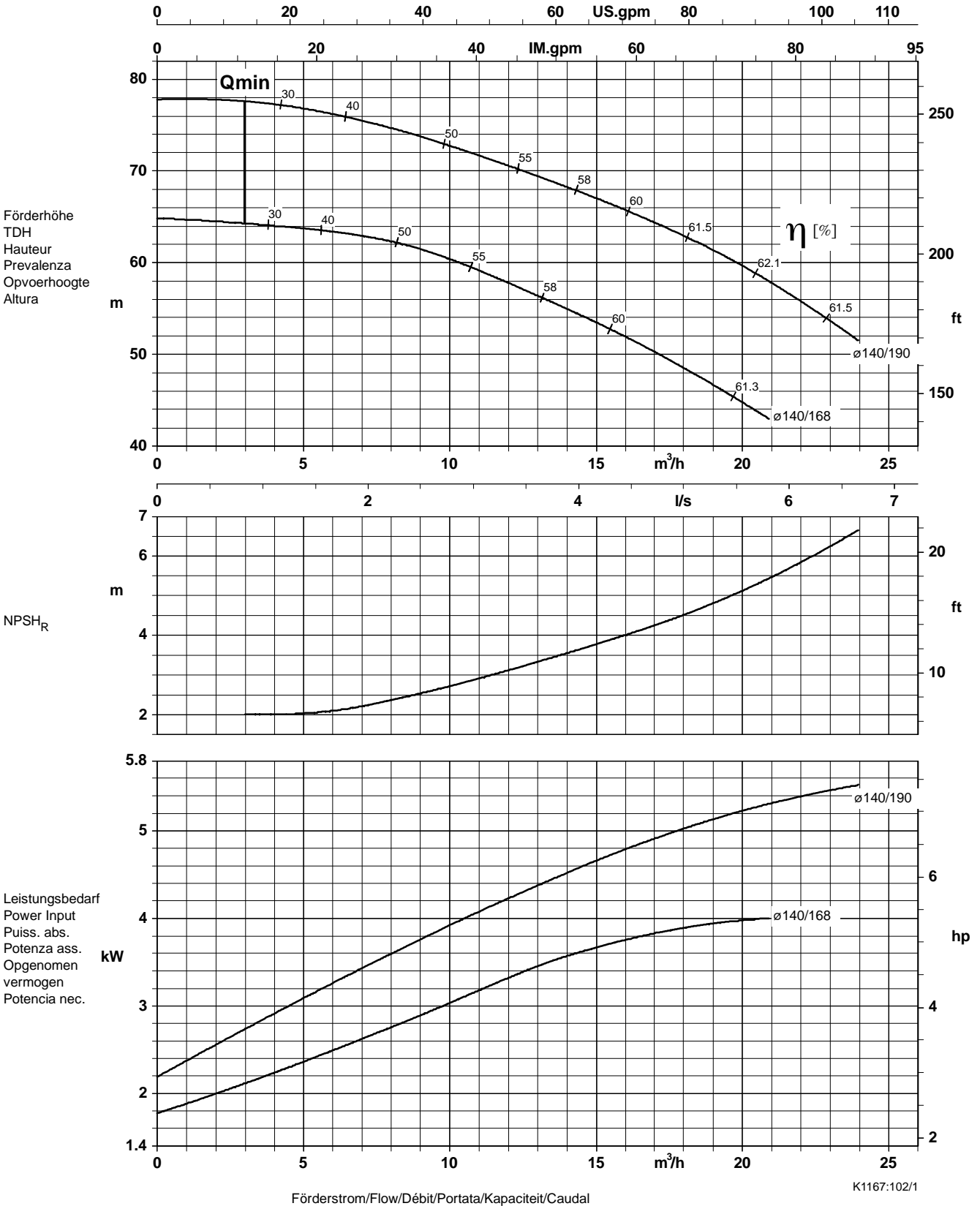

K1167:102/1

Baureihe-Größe Type-Size Modèle	Tipo Serie Tipo	Nenn Drehzahl Nom. speed Vitesse nom.	Velocità di rotazione nom. Nominaal toerental Revoluciones nom.	Lauf rad- \varnothing Impeller Dia. Diamètre de roue	\varnothing Girante \varnothing Waaier \varnothing Rodete	 KSB Aktiengesellschaft Unternehmensbereich Pumpen Industrie- und Wassertechnik Postfach 1725, 67225 Frankenthal Joh.-Klein-Str. 9, 67227 Frankenthal
Etanorm 32-125.1 Etabloc		2900 1/min				
Projekt Project Projet	Progetto Projekt Proyecto	Angebots-Nr. Project No. No. de l'offre	Offerta-No. Offertenr. Offerta-No.	Pos.-Nr. Item No. No. de pos.	Pos.-Nr. Positiëntr. Pos.-Nr.	

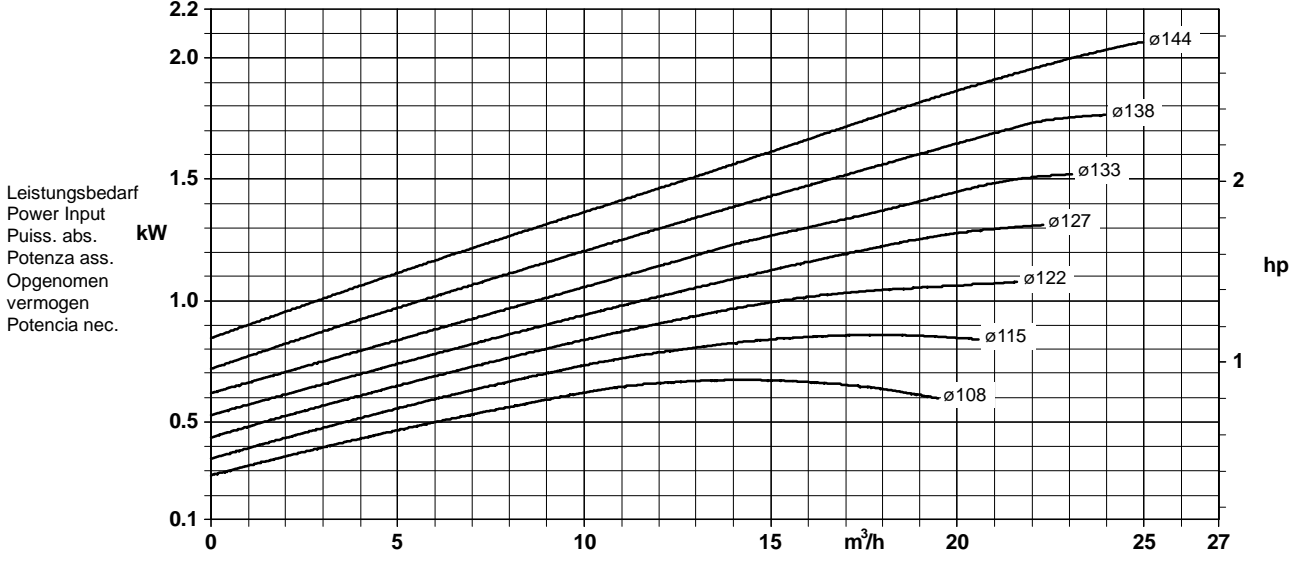
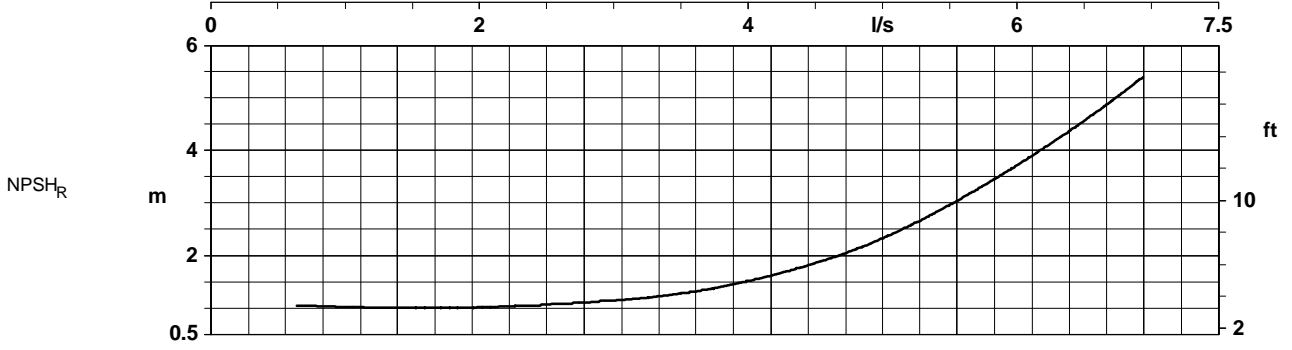
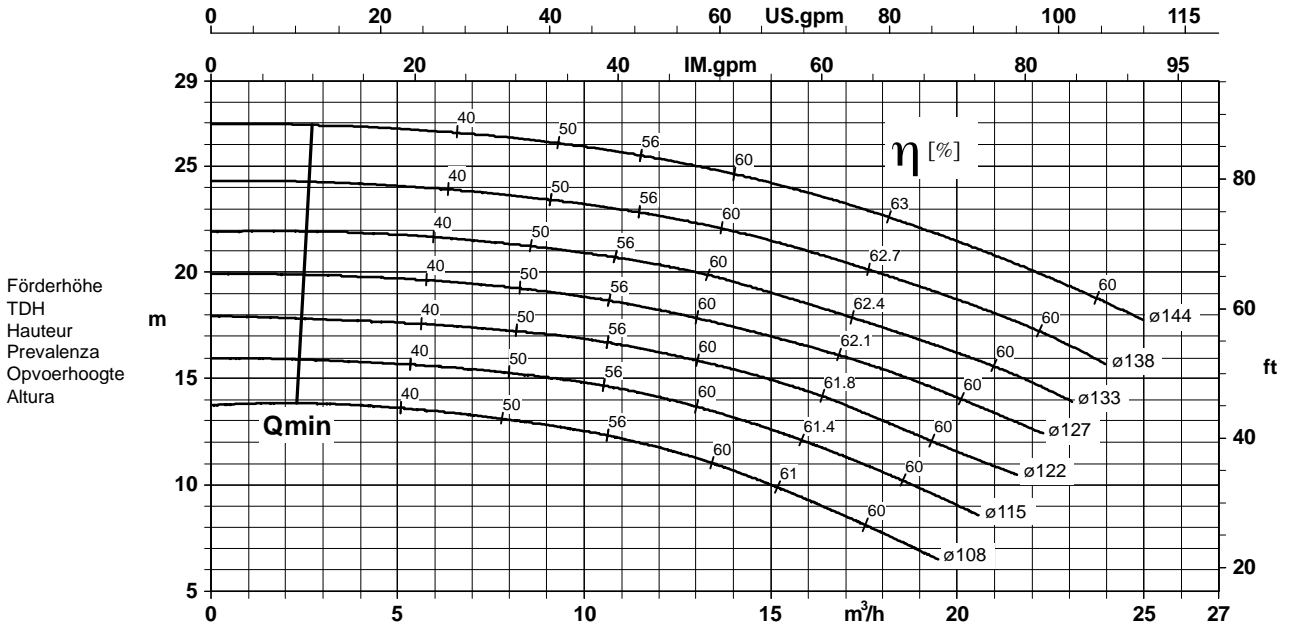

Förderstrom/Flow/Débit/Portata/Kapaciteit/Caudal

K1211.452/151/6

Laufradaustrittsbreite/Impeller outlet width/Largeur à la sortie de la roue 5,0 mm
 Luce della girante/Waaier uittredebreedte/Anchura de salida rodete 5,0 mm

Baureihe-Größe Type-Size Modèle	Tipo Serie Tipo	Nennzahl Nom. speed Vitesse nom.	Velocità di rotazione nom. Nominaal toerental Revoluciones nom.	Laufrad-Ø Impeller Dia. Diamètre de roue	Ø Girante Ø Waaier Ø Rodete	 KSB Aktiengesellschaft Unternehmensbereich Pumpen Industrie- und Wassertechnik Postfach 1725, 67225 Frankenthal Joh.-Klein-Str. 9, 67227 Frankenthal
Etanorm 32-160.1 Etabloc		2900 1/min				
Projekt Project Projet	Progetto Projekt Proyecto	Angebots-Nr. Project No. No. de l'offre	Offerta-No. Offertenr. Offerta-No.	Pos.-Nr. Item No. No. de pos.	Pos.-Nr. Positiennr. Pos.-Nr.	

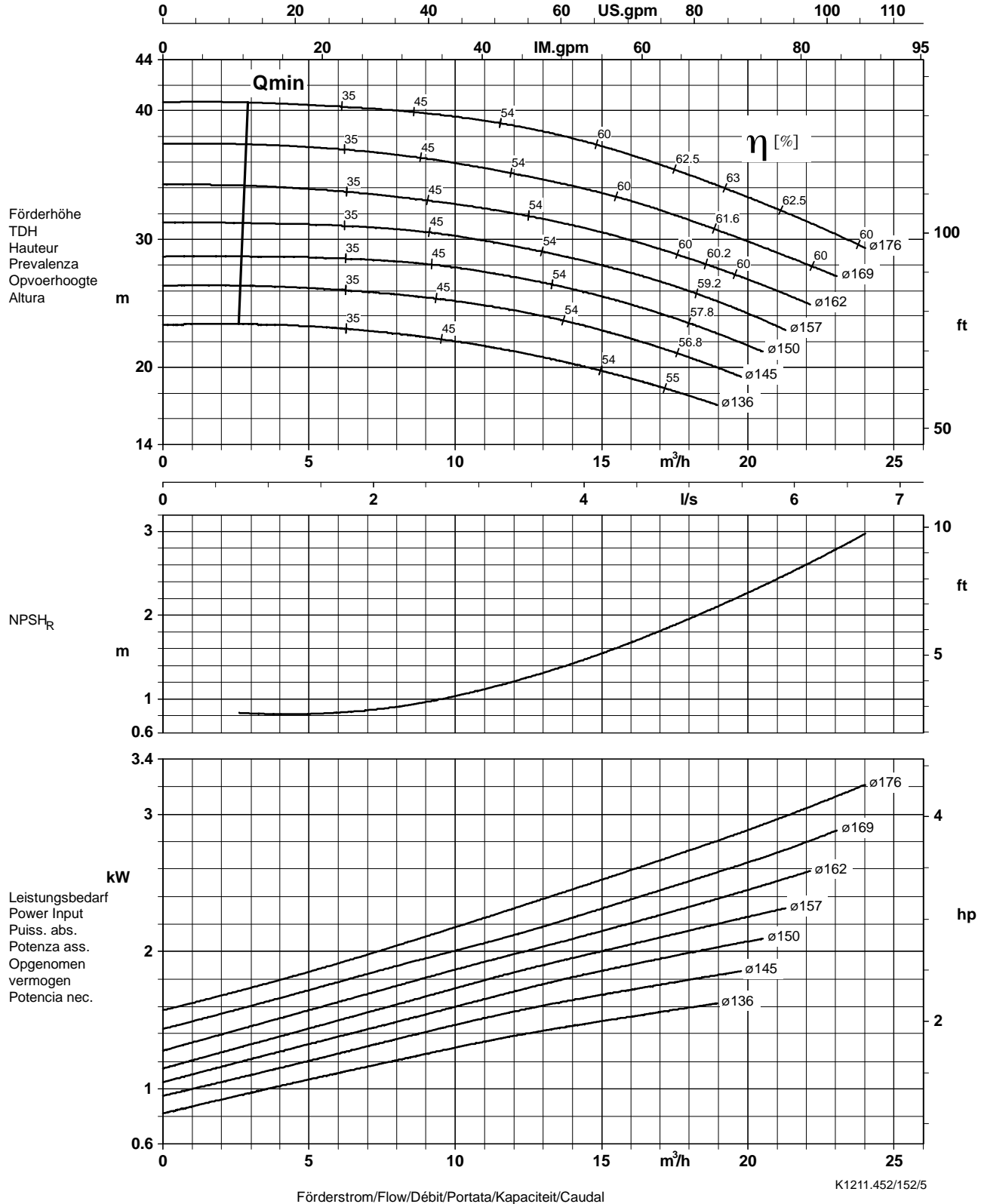

Laufradaustrittsbreite/Impeller outlet width/Largeur à la sortie de la roue 5,6 mm
 Luce della girante/Waaier uitredbreedte/Anchura de salida rodete 5,6 mm

Baureihe-Größe Type-Size Modèle	Tipo Serie Tipo	Neendrehzahl Nom. speed Vitesse nom.	Velocità di rotazione nom. Nominaal toerental Revoluciones nom.	Laufrad- ϕ Impeller Dia. Diamètre de roue	ϕ Girante ϕ Waaier ϕ Rodete	 KSB Aktiengesellschaft Unternehmensbereich Pumpen Industrie- und Wassertechnik Postfach 1725, 67225 Frankenthal Joh.-Klein-Str. 9, 67227 Frankenthal
Etanorm 32-200.1 Etabloc		2900 1/min				
Projekt Project Projet	Progetto Projekt Proyecto	Angebots-Nr. Project No. No. de l'offre	Offerta-No. Offertenr. Offerta-No.	Pos.-Nr. Item No. No. de pos.	Pos.-Nr. Positiën. Pos.-Nr.	

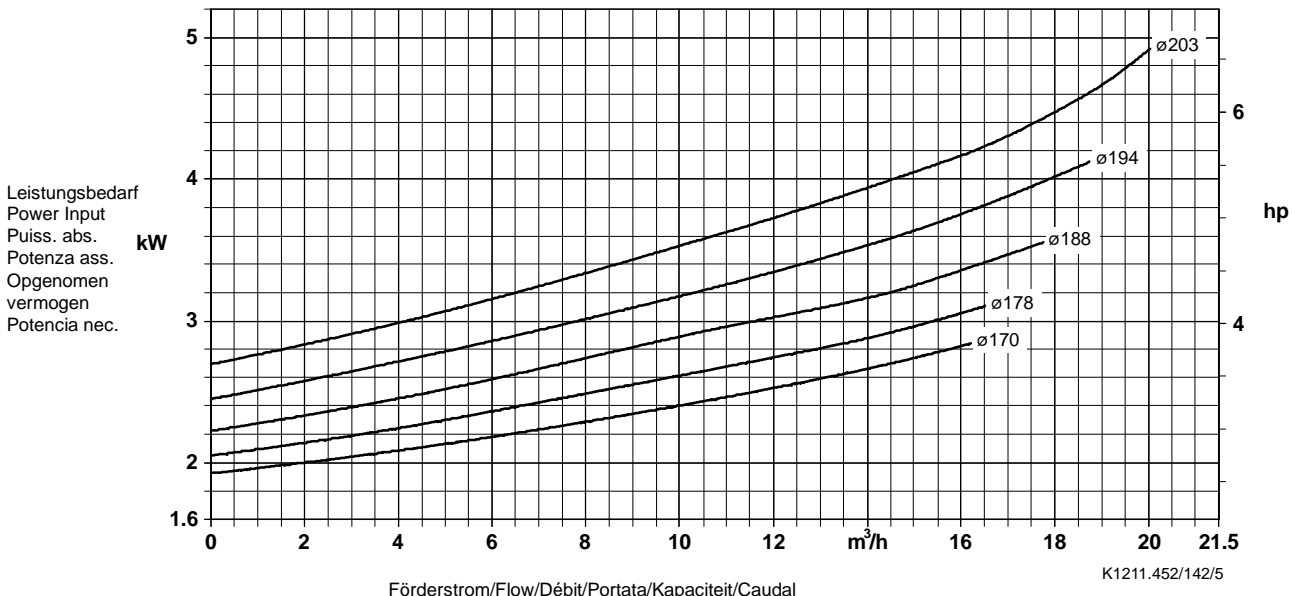
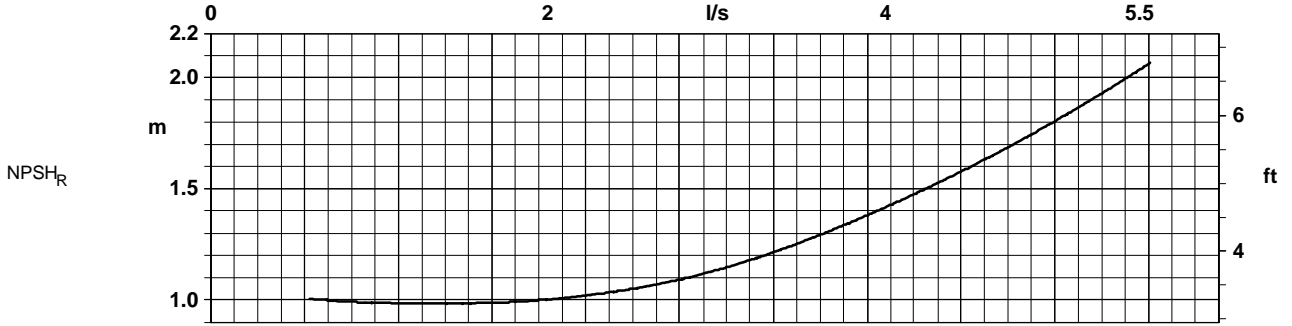
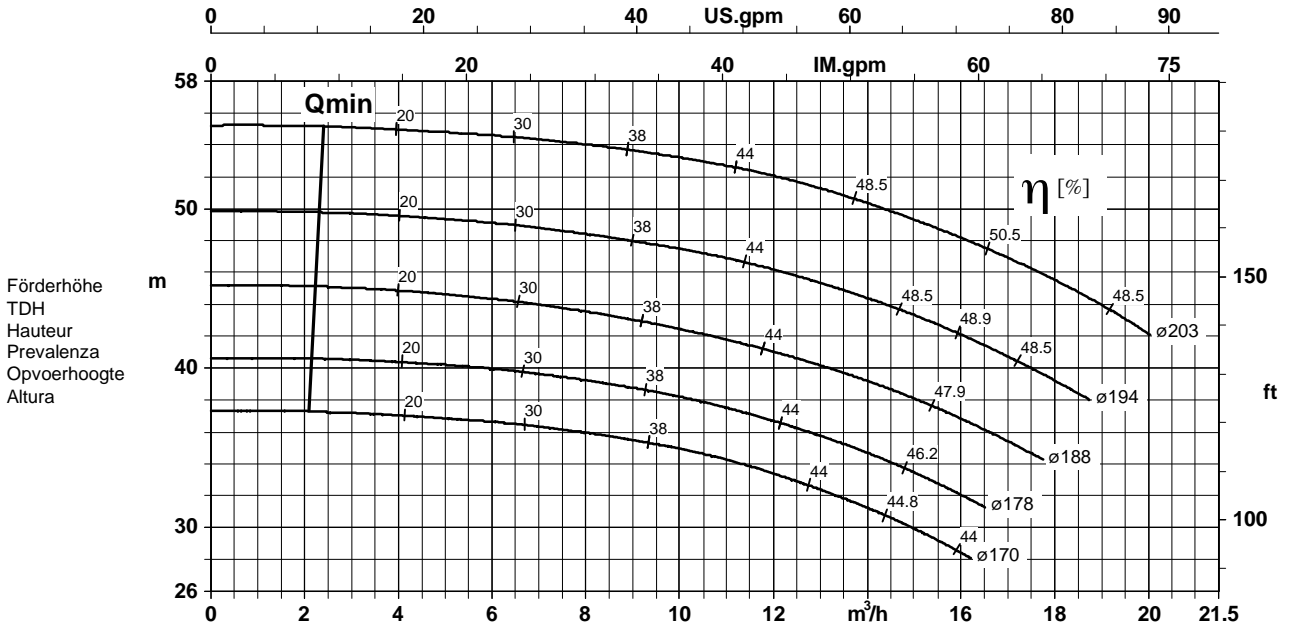

Laufradaustrittsbreite/Impeller outlet width/Largeur à la sortie de la roue 6,0 mm
 Luce della girante/Waaier uittredebreedte/Anchura de salida rodete 6,0 mm

Baureihe-Größe Type-Size Modèle	Tipo Serie Tipo	Nenn Drehzahl Nom. speed Vitesse nom.	Velocità di rotazione nom. Nominaal toerental Revoluciones nom.	Lauf rad-ø Impeller Dia. Diamètre de roue	ø Girante ø Waaier ø Rodete	 KSB Aktiengesellschaft Unternehmensbereich Pumpen Industrie- und Wassertechnik Postfach 1725, 67225 Frankenthal Joh.-Klein-Str. 9, 67227 Frankenthal
Etanorm 32-250.1 Etabloc		2900 1/min				
Projekt Project Projet	Progetto Projecto Proyecto	Angebots-Nr. Project No. No. de l'offre	Offerta-No. Offertenr. Offerta-No.	Pos.-Nr. Item No. No. de pos.	Pos.-Nr. Positiennr. Pos.-Nr.	

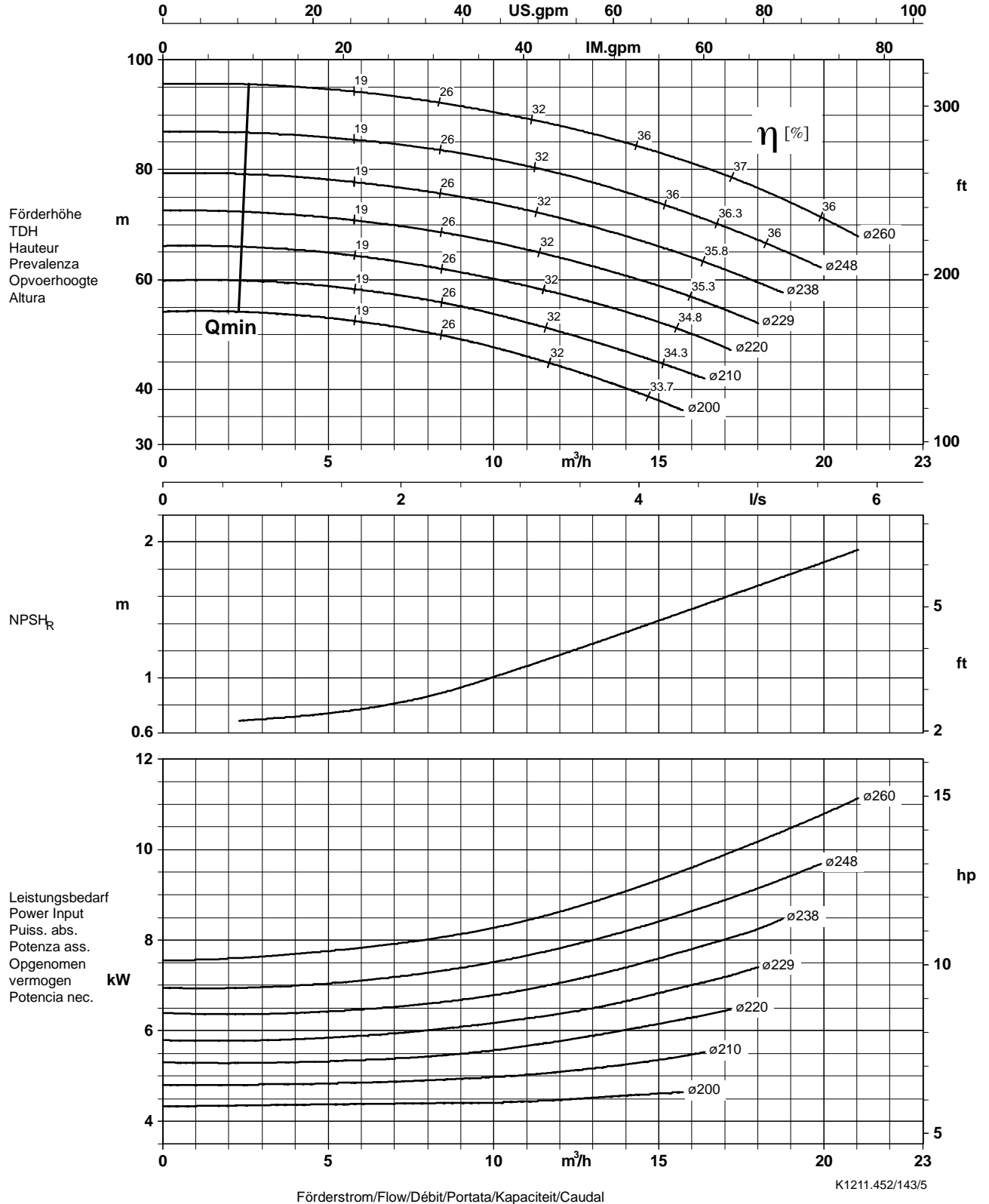

Lauf rad austrittsbreite/Impeller outlet width/Largeur à la sortie de la roue 8,0 mm
 Luce della girante/Waaier uitred breedte/Anchura de salida rodete 8,0 mm

Baureihe-Größe Type-Size Modèle	Tipo Serie Tipo	Nenn Drehzahl Nom. speed Vitesse nom.	Velocità di rotazione nom. Nominaal toerental Revoluciones nom.	Lauf rad- ϕ Impeller Dia. Diamètre de roue	ϕ Girante ϕ Waaier ϕ Rodete	 KSB Aktiengesellschaft Unternehmensbereich Pumpen Industrie- und Wassertechnik Postfach 1725, 67225 Frankenthal Joh.-Klein-Str. 9, 67227 Frankenthal
Etanorm 32-125 Etabloc		2900 1/min				
Projekt Project Projet	Progetto Projekt Proyecto	Angebots-Nr. Project No. No. de l'offre	Offerta-No. Offerten. Offerta-No.	Pos.-Nr. Item No. No. de pos.	Pos.-Nr. Positiën. Pos.-Nr.	

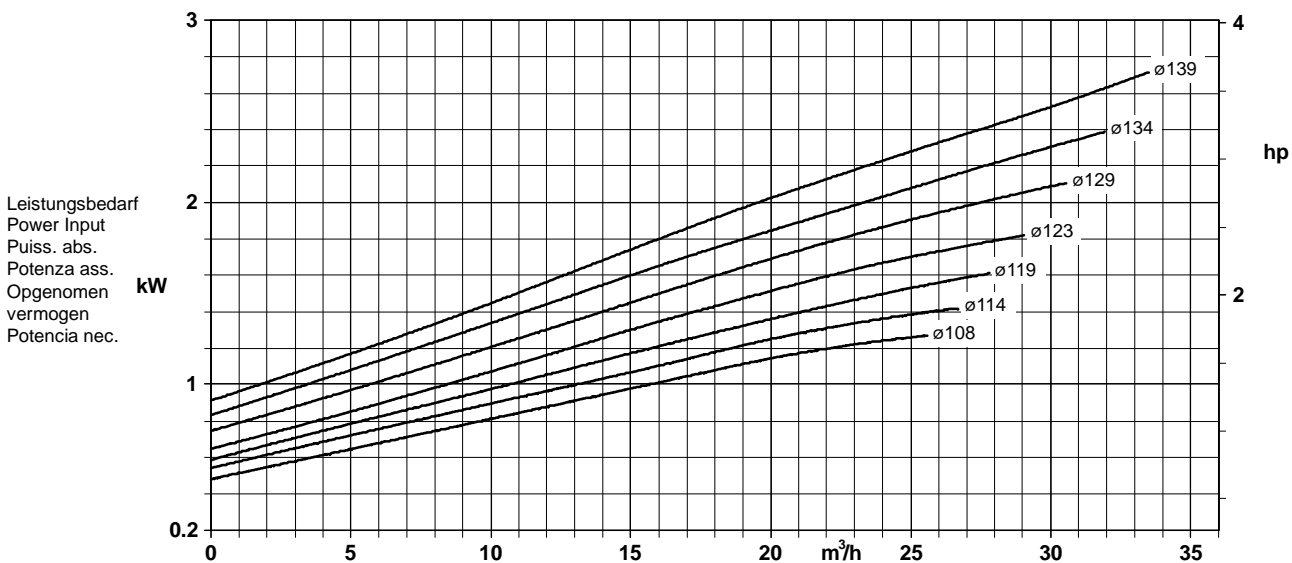
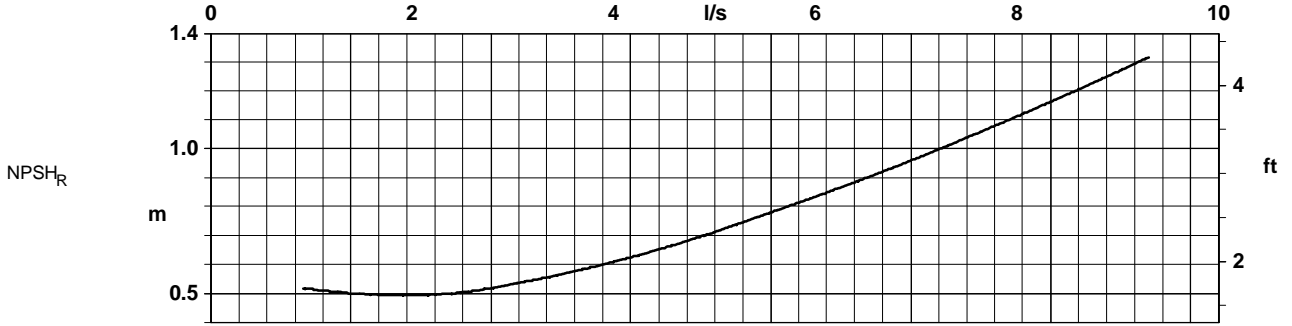
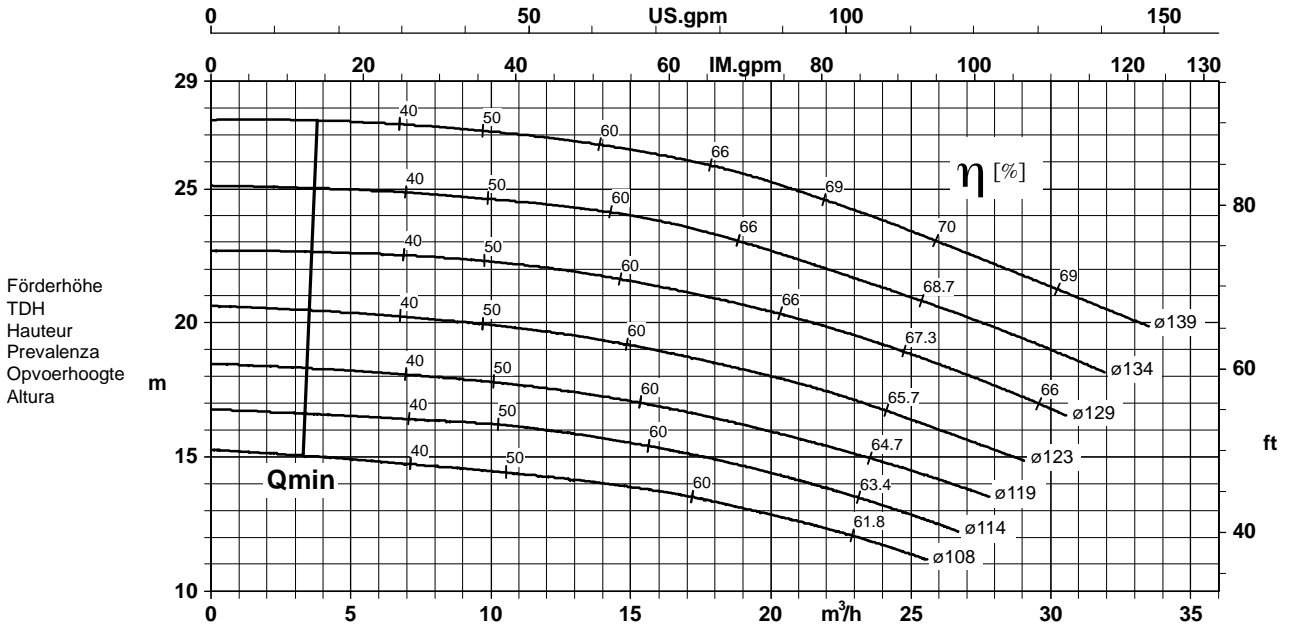

K1211.452/181/5

Lauf rad austrittsbreite / Impeller outlet width / Largeur à la sortie de la roue 9,6 mm
 Luce della girante / Waaier uittredebreedte / Anchura de salida rodete 9,6 mm

Baureihe-Größe Type-Size Modèle	Tipo Serie Tipo	Nennzahl Nom. speed Vitesse nom.	Velocità di rotazione nom. Nominaal toerental Revoluciones nom.	Laufgrad-ø Impeller Dia. Diamètre de roue	ø Girante ø Waaier ø Rodete	 KSB Aktiengesellschaft Unternehmensbereich Pumpen Industrie- und Wassertechnik Postfach 1725, 67225 Frankenthal Joh.-Klein-Str. 9, 67227 Frankenthal
Etanorm 32-160 Etabloc		2900 1/min				
Projekt Project Projet	Progetto Projekt Proyecto	Angebots-Nr. Project No. No. de l'offre	Offerta-No. Offertenr. Offerta-No.	Pos.-Nr. Item No. No. de pos.	Pos.-Nr. Positiennr. Pos.-Nr.	

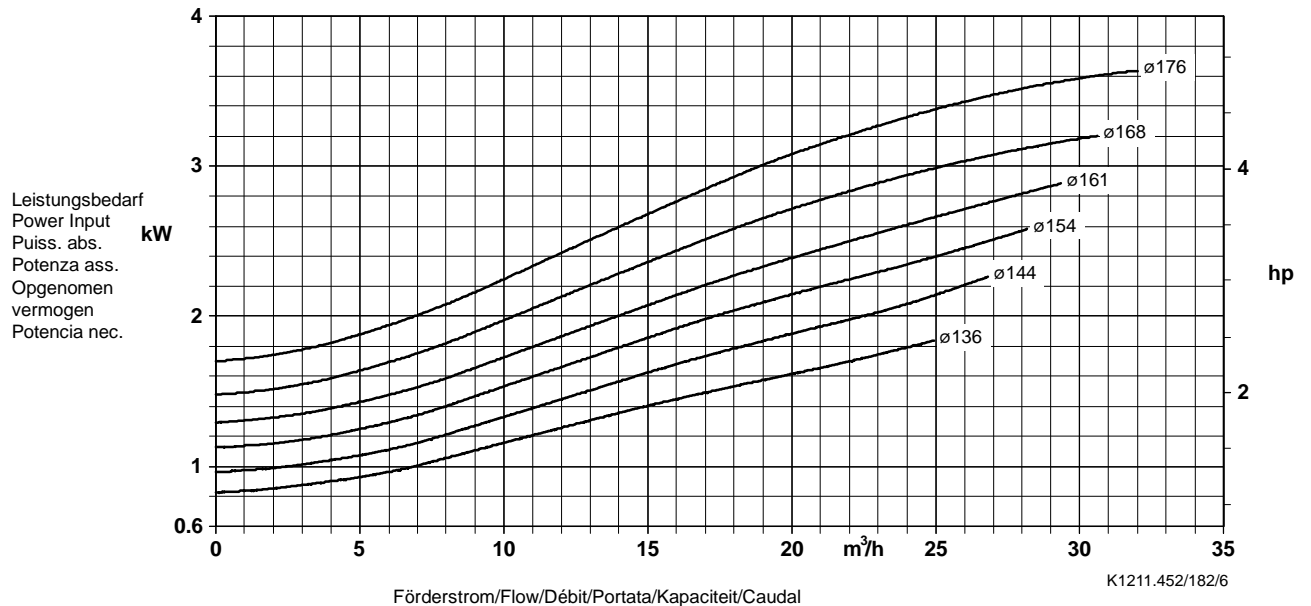
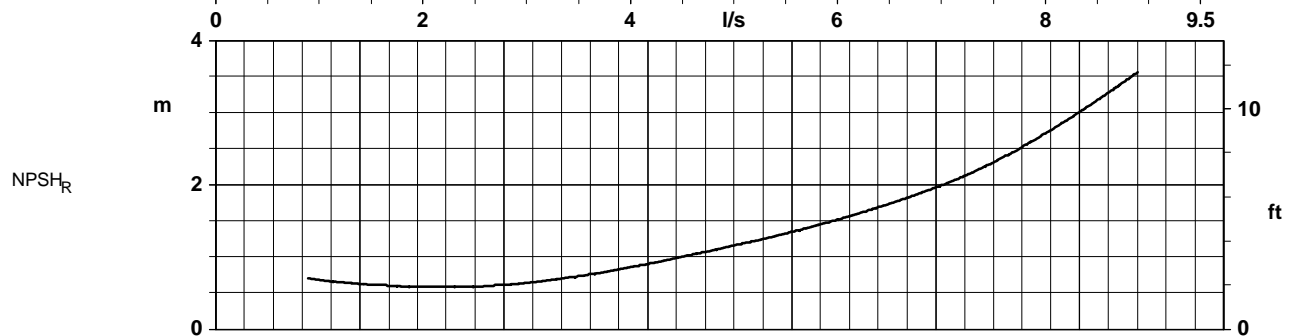
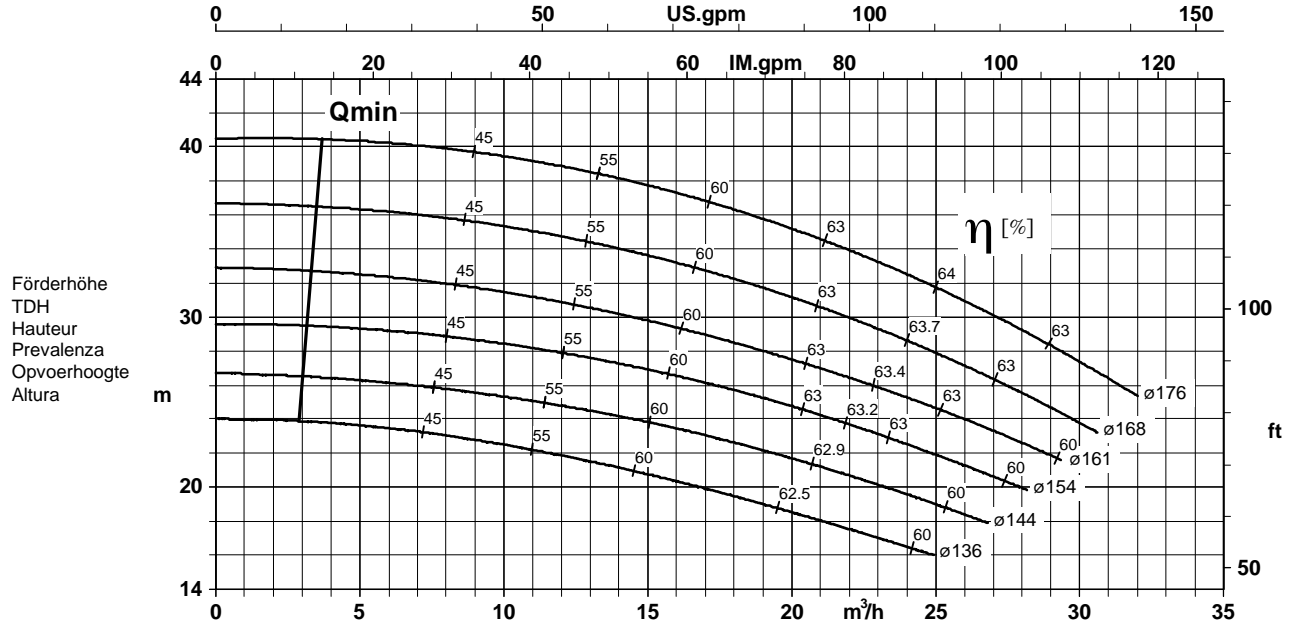

Laufradaustrittsbreite/Impeller outlet width/Largeur à la sortie de la roue 5,6 mm
 Luce della girante/Waaier uitredbreedte/Anchura de salida rodete 5,6 mm

Baureihe-Größe Type-Size Modèle	Tipo Serie Tipo	Neendrehzahl Nom. speed Vitesse nom.	Velocità di rotazione nom. Nominaal toerental Revoluciones nom.	Laufrad- ϕ Impeller Dia. Diamètre de roue	ϕ Girante ϕ Waaier ϕ Rodete	 KSB Aktiengesellschaft Unternehmensbereich Pumpen Industrie- und Wassertechnik Postfach 1725, 67225 Frankenthal Joh.-Klein-Str. 9, 67227 Frankenthal
Etanorm 32-200 Etabloc		2900 1/min				
Projekt Project Projet	Progetto Projekt Proyecto	Angebots-Nr. Project No. No. de l'offre	Offerta-No. Offertenr. Offerta-No.	Pos.-Nr. Item No. No. de pos.	Pos.-Nr. Positiën. Pos.-Nr.	

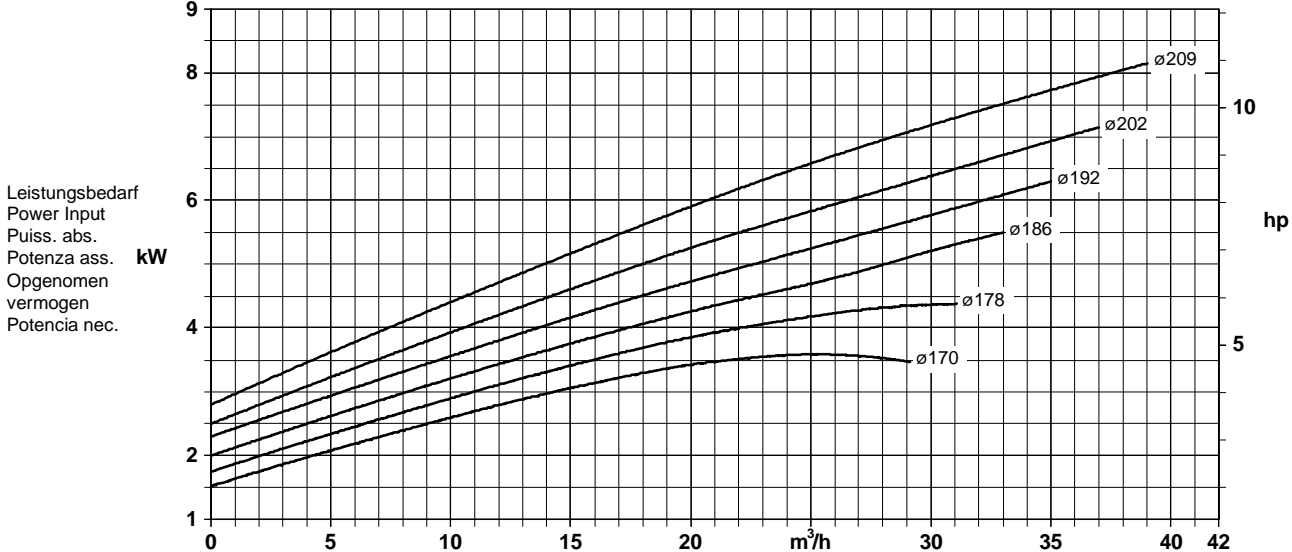
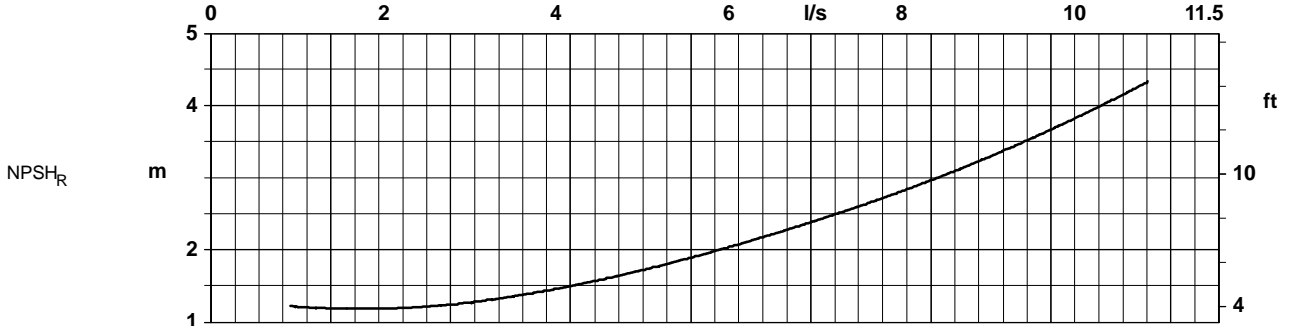
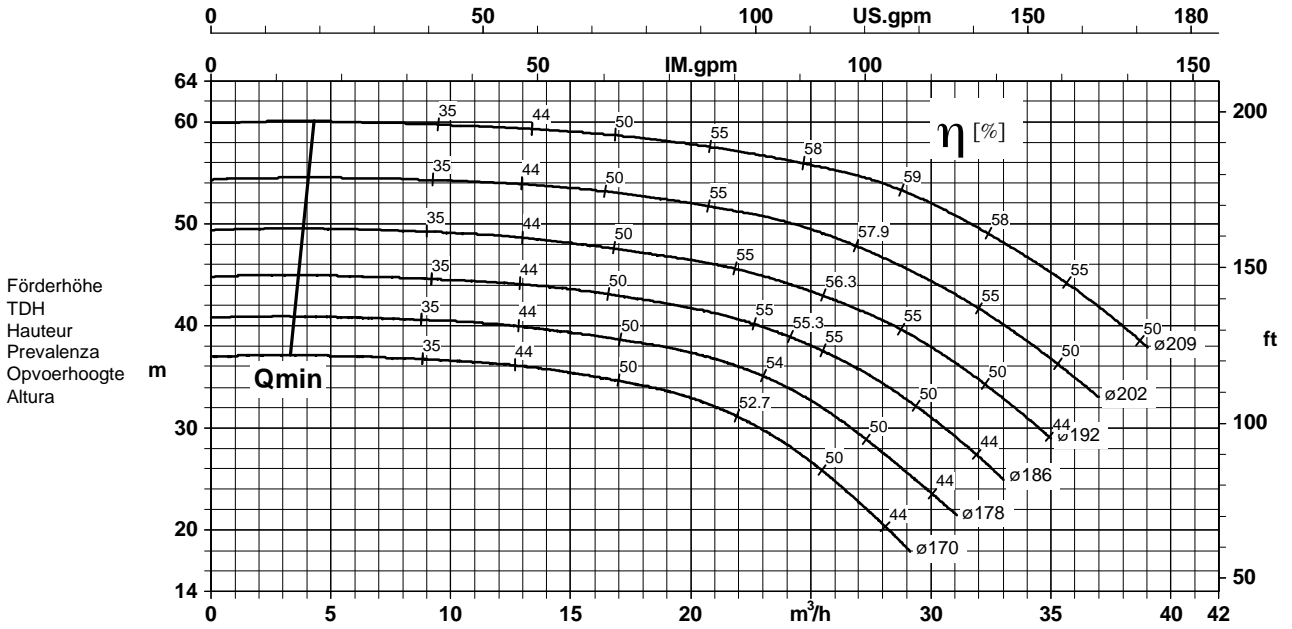

Förderstrom/Flow/Débit/Portata/Kapaciteit/Caudal

K1211.452/183/5

Laufradaustrittsbreite/Impeller outlet width/Largeur à la sortie de la roue 6,0 mm
 Luce della girante/Waaier uittredebreedte/Anchura de salida rodete 6,0 mm

Baureihe-Größe Type-Size Modèle	Tipo Serie Tipo	Nennzahl Nom. speed Vitesse nom.	Velocità di rotazione nom. Nominaal toerental Revoluciones nom.	Laufrad-ø Impeller Dia. Diamètre de roue	ø Girante ø Waaier ø Rodete	 KSB Aktiengesellschaft Unternehmensbereich Pumpen Industrie- und Wassertechnik Postfach 1725, 67225 Frankenthal Joh.-Klein-Str. 9, 67227 Frankenthal
Etanorm 32-250 Etabloc		2900 1/min				
Projekt Project Projet	Progetto Projekt Proyecto	Angebots-Nr. Project No. No. de l'offre	Offerta-No. Offertenr. Offerta-No.	Pos.-Nr. Item No. No. de pos.	Pos.-Nr. Positiennr. Pos.-Nr.	

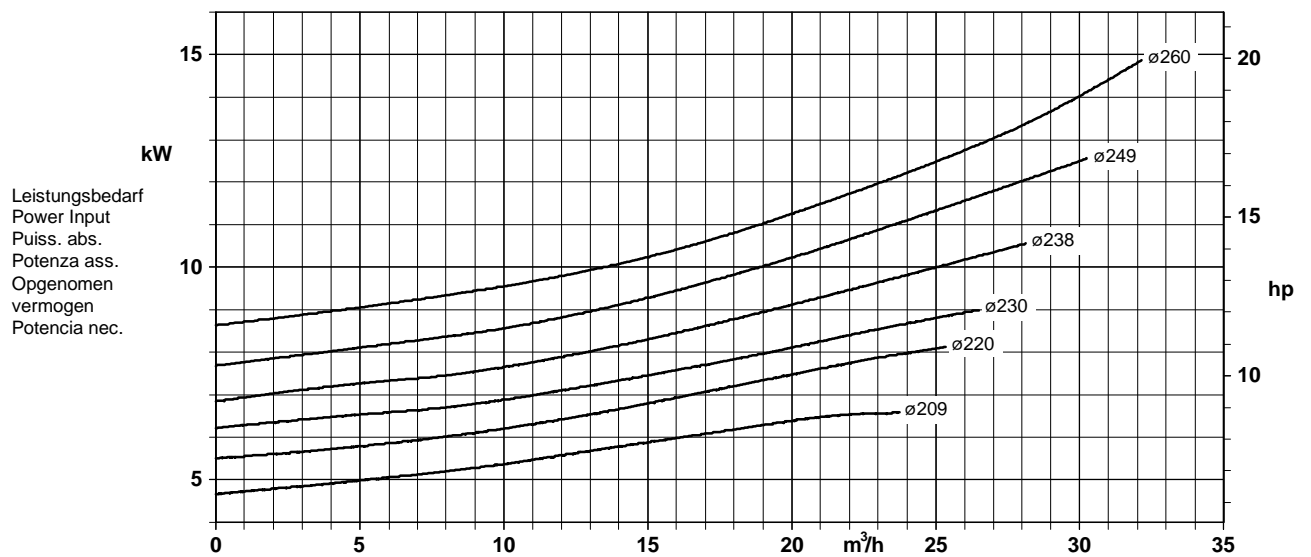
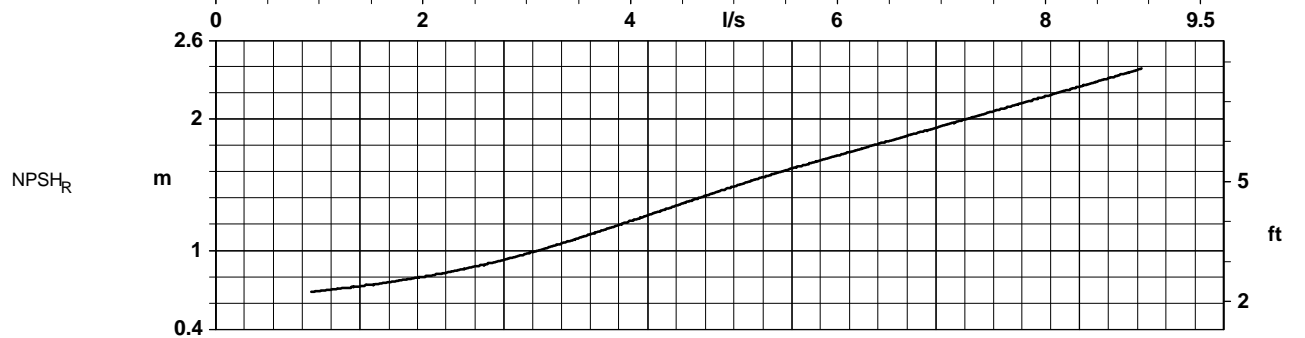
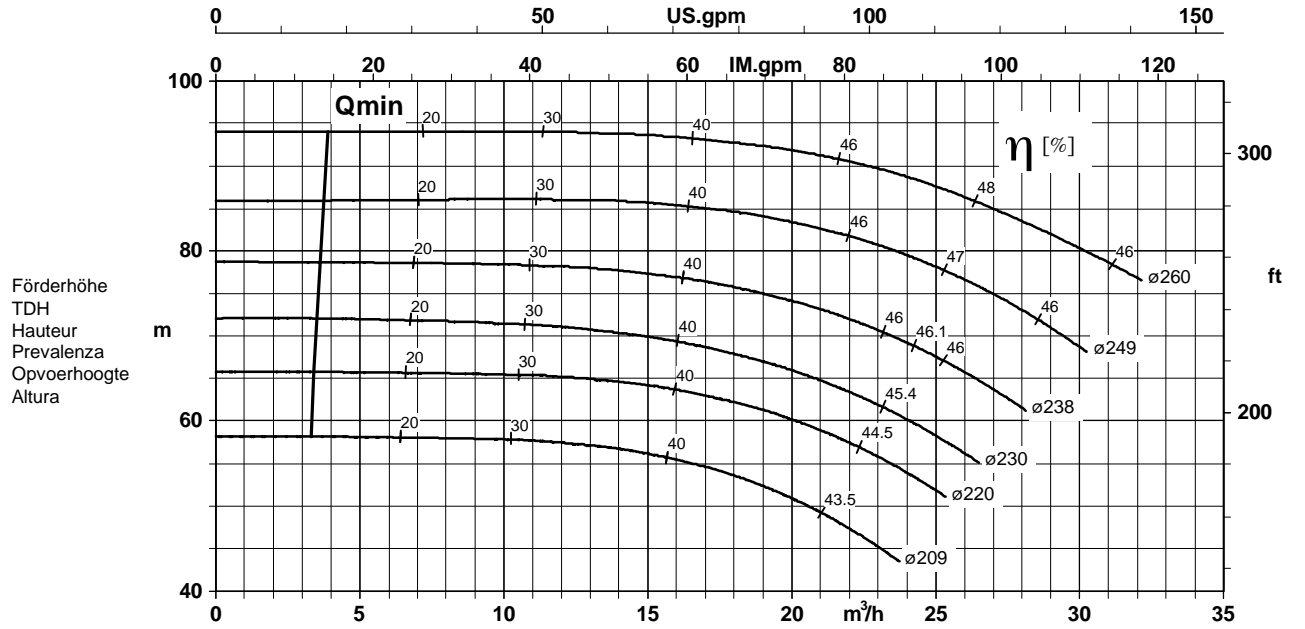

Förderstrom/Flow/Débit/Portata/Kapazität/Caudal

K1211.452/184/5

Laufradaustrittsbreite/Impeller outlet width/Largeur à la sortie de la roue 8,0 mm
 Luce della girante/Waaier uitredbreedte/Anchura de salida rodete 8,0 mm

Baureihe-Größe Type-Size Modèle	Tipo Serie Tipo	Nenn Drehzahl Nom. speed Vitesse nom.	Velocità di rotazione nom. Nominaal toerental Revoluciones nom.	Lauf rad- ϕ Impeller Dia. Diamètre de roue	ϕ Girante ϕ Waaier ϕ Rodete	 KSB Aktiengesellschaft Unternehmensbereich Pumpen Industrie- und Wassertechnik Postfach 1725, 67225 Frankenthal Joh.-Klein-Str. 9, 67227 Frankenthal
Etanorm 40-125 Etabloc		2900 1/min				
Projekt Project Projet	Progetto Projekt Proyecto	Angebots-Nr. Project No. No. de l'offre	Offerta-No. Offertenr. Offerta-No.	Pos.-Nr. Item No. No. de pos.	Pos.-Nr. Positiën. Pos.-Nr.	

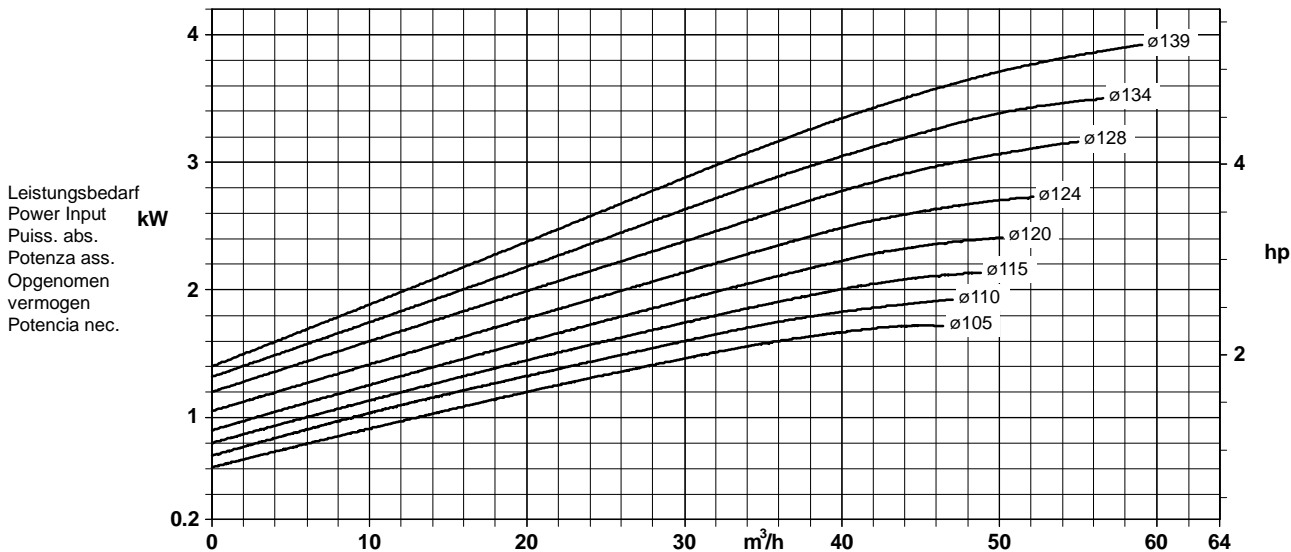
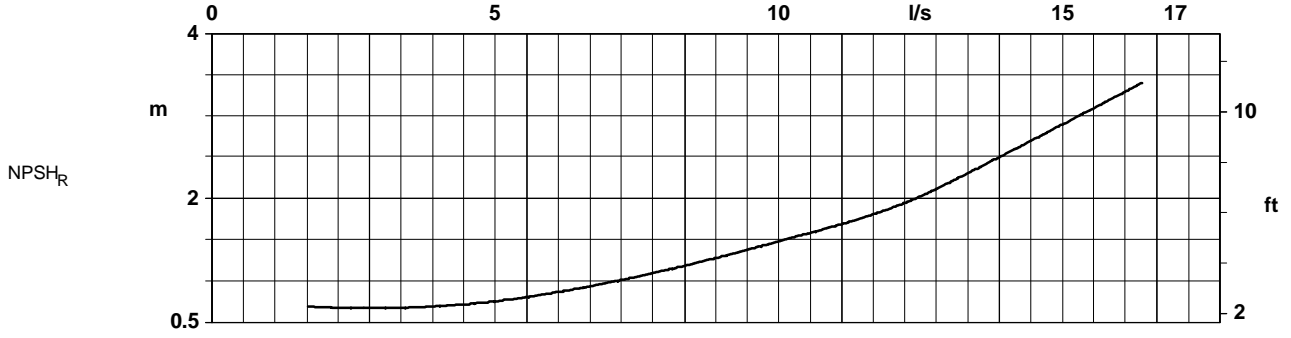
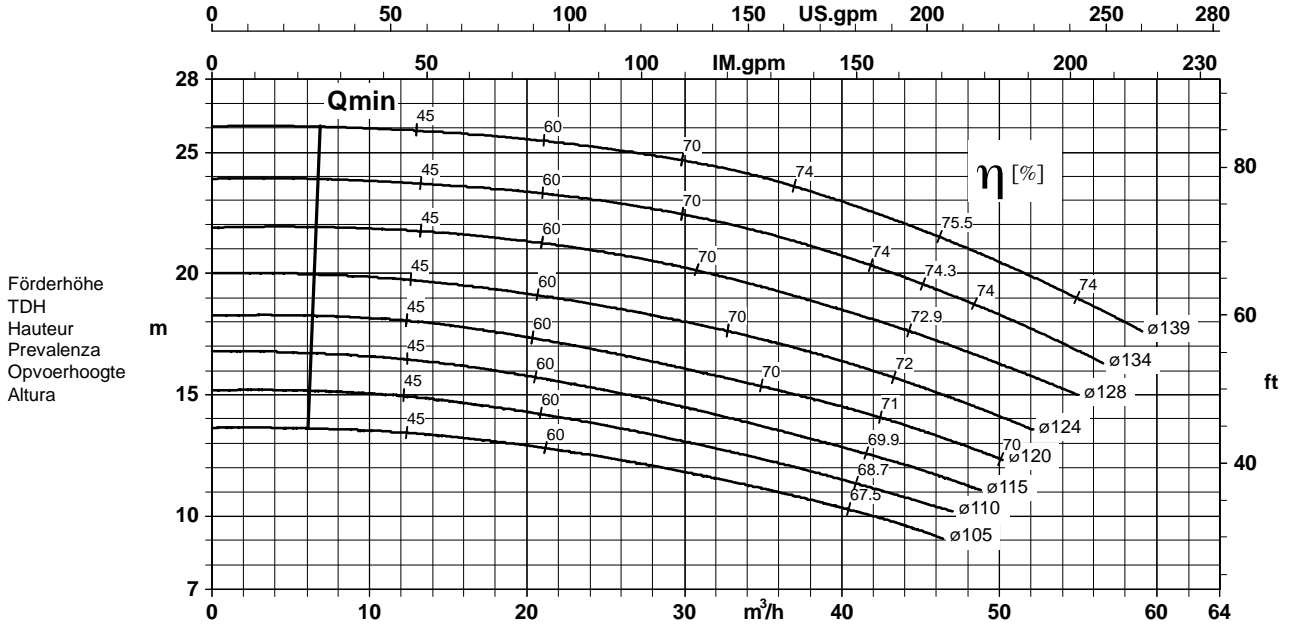

Förderstrom/Flow/Débit/Portata/Kapaciteit/Caudal

K1211.452/231/5

Laufradaustrittsbreite/Impeller outlet width/Largeur à la sortie de la roue 14,0 mm
 Luce della girante/Waaier uittredebreedte/Anchura de salida rodete 14,0 mm

Baureihe-Größe Type-Size Modèle	Tipo Serie Tipo	Nennzahl Nom. speed Vitesse nom.	Velocità di rotazione nom. Nominaal toerental Revoluciones nom.	Laufrad-ø Impeller Dia. Diamètre de roue	ø Girante ø Waaier ø Rodete	 KSB Aktiengesellschaft Unternehmensbereich Pumpen Industrie- und Wassertechnik Postfach 1725, 67225 Frankenthal Joh.-Klein-Str. 9, 67227 Frankenthal
Etanorm 40-160 Etabloc		2900 1/min				
Projekt Project Projet	Progetto Projekt Proyecto	Angebots-Nr. Project No. No. de l'offre	Offerta-No. Offertenr. Offerta-No.	Pos.-Nr. Item No. No. de pos.	Pos.-Nr. Positiën. Pos.-Nr.	

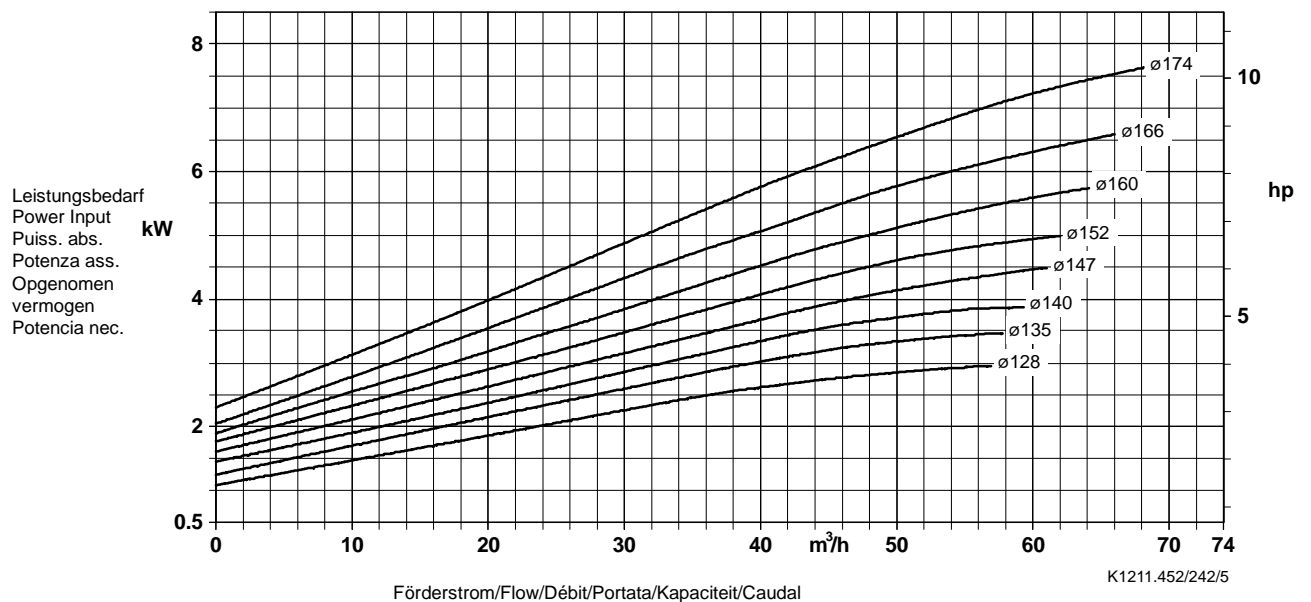
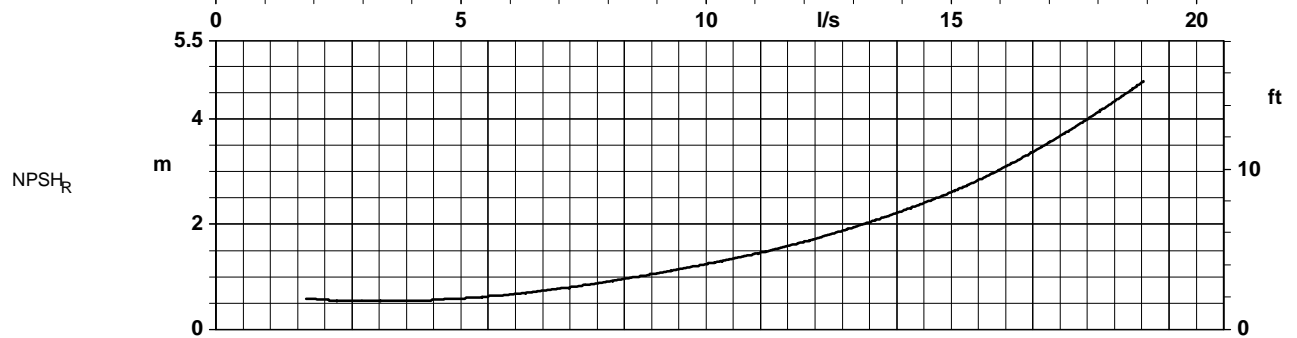
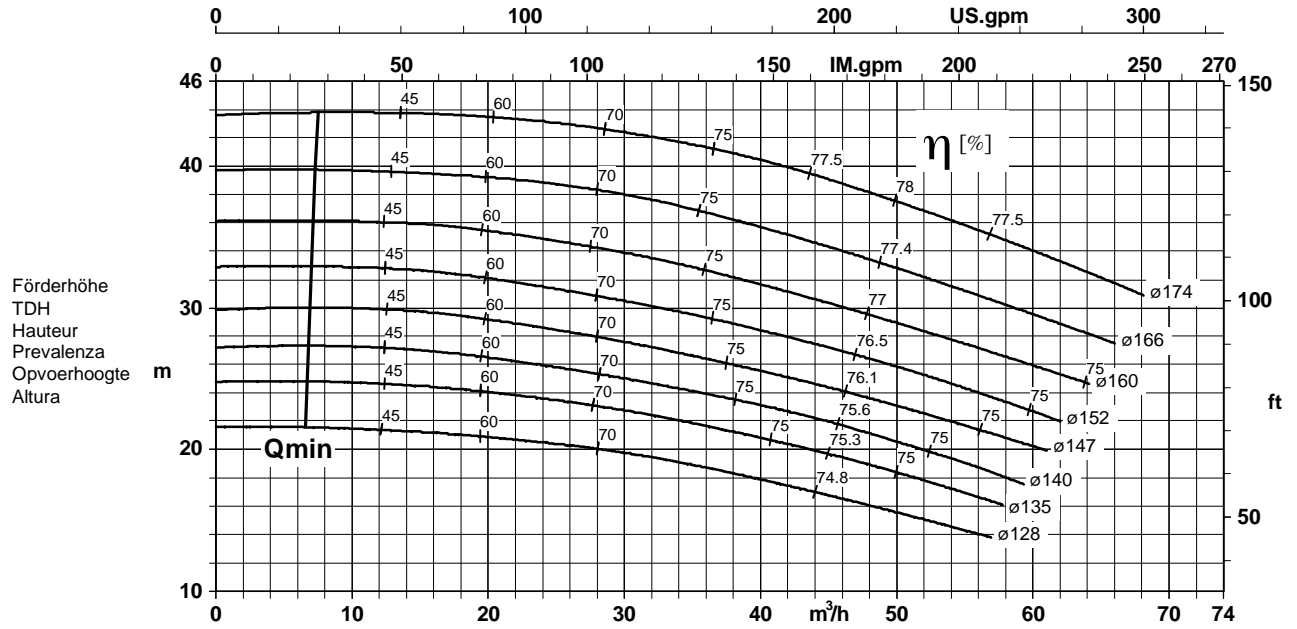

Laufradaustrittsbreite/Impeller outlet width/Largeur à la sortie de la roue 12,0 mm
 Luce della girante/Waaier uitredbreedte/Anchura de salida rodete 12,0 mm

Baureihe-Größe Type-Size Modèle	Tipo Serie Tipo	Nenn Drehzahl Nom. speed Vitesse nom.	Velocità di rotazione nom. Nominaal toerental Revoluciones nom.	Lauf rad- ϕ Impeller Dia. Diamètre de roue	ϕ Girante ϕ Waaier ϕ Rodete	 KSB Aktiengesellschaft Unternehmensbereich Pumpen Industrie- und Wassertechnik Postfach 1725, 67225 Frankenthal Joh.-Klein-Str. 9, 67227 Frankenthal
Etanorm 40-200 Etabloc		2900 1/min				
Projekt Project Projet	Progetto Projekt Proyecto	Angebots-Nr. Project No. No. de l'offre	Offerta-No. Offertenr. Offerta-No.	Pos.-Nr. Item No. No. de pos.	Pos.-Nr. Positiën. Pos.-Nr.	

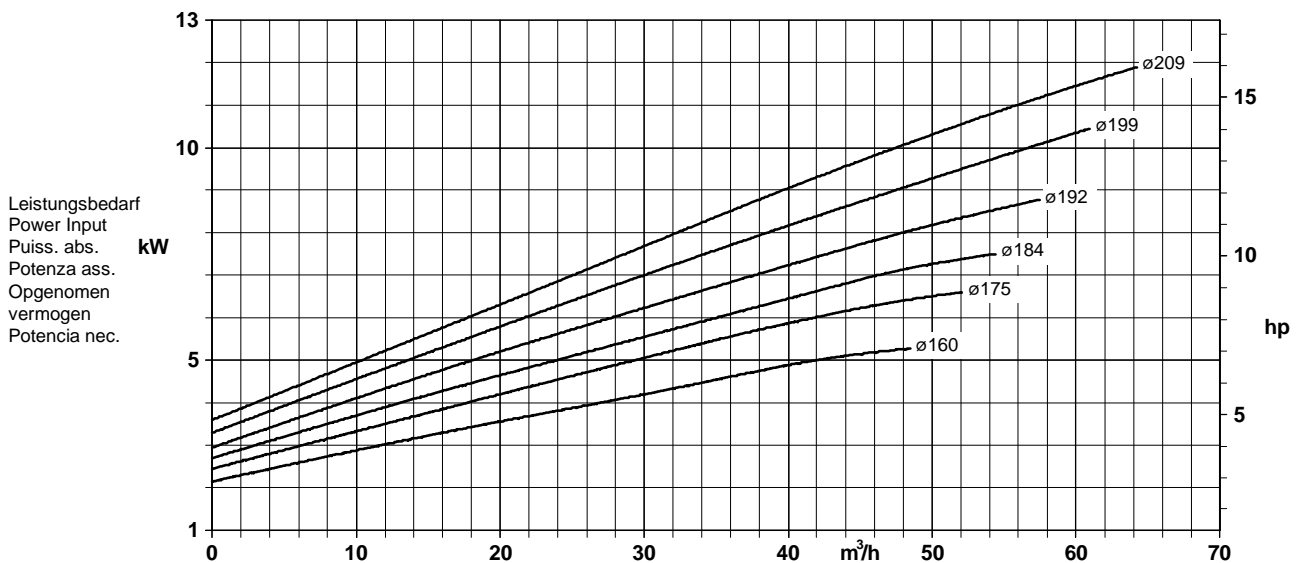
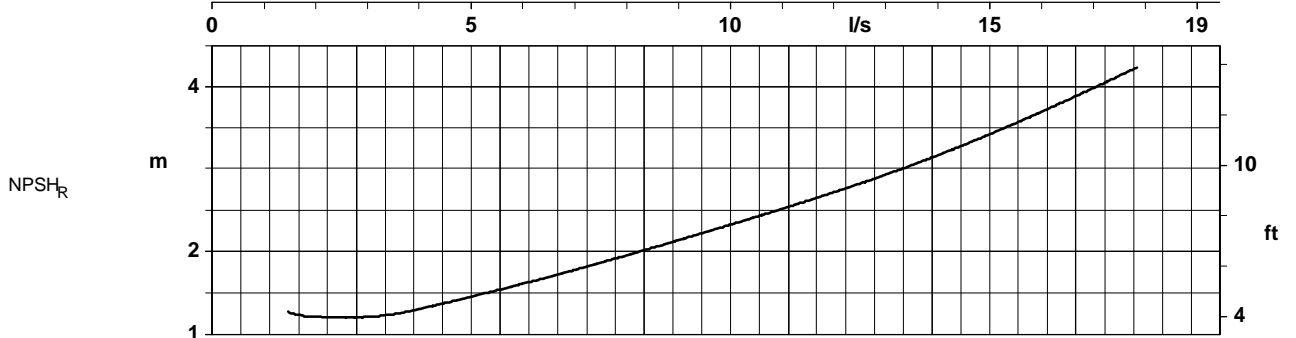
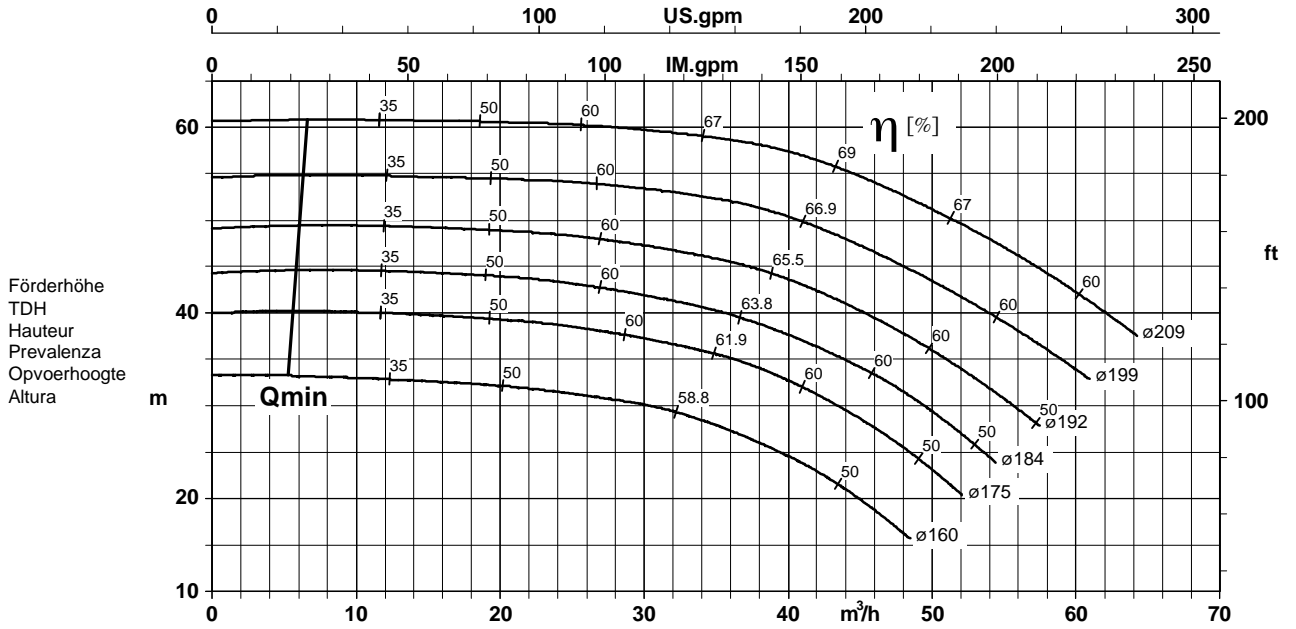

Förderstrom/Flow/Débit/Portata/Kapazität/Caudal K1211.452/223/5

Lauf rad austrittsbreite/Impeller outlet width/Largeur à la sortie de la roue 9,0 mm
 Luce della girante/Waaier uittredbreedte/Anchura de salida rodete 9,0 mm

Baureihe-Größe Type-Size Modèle	Tipo Serie Tipo	Nennzahl Nom. speed Vitesse nom.	Velocità di rotazione nom. Nominaal toerental Revoluciones nom.	Laufrad-ø Impeller Dia. Diamètre de roue	ø Girante ø Waaier ø Rodete	 KSB Aktiengesellschaft Unternehmensbereich Pumpen Industrie- und Wassertechnik Postfach 1725, 67225 Frankenthal Joh.-Klein-Str. 9, 67227 Frankenthal
Etanorm 40-250 Etabloc		2900 1/min				
Projekt Project Projet	Progetto Projekt Proyecto	Angebots-Nr. Project No. No. de l'offre	Offerta-No. Offertenr. Offerta-No.	Pos.-Nr. Item No. No. de pos.	Pos.-Nr. Positiennr. Pos.-Nr.	

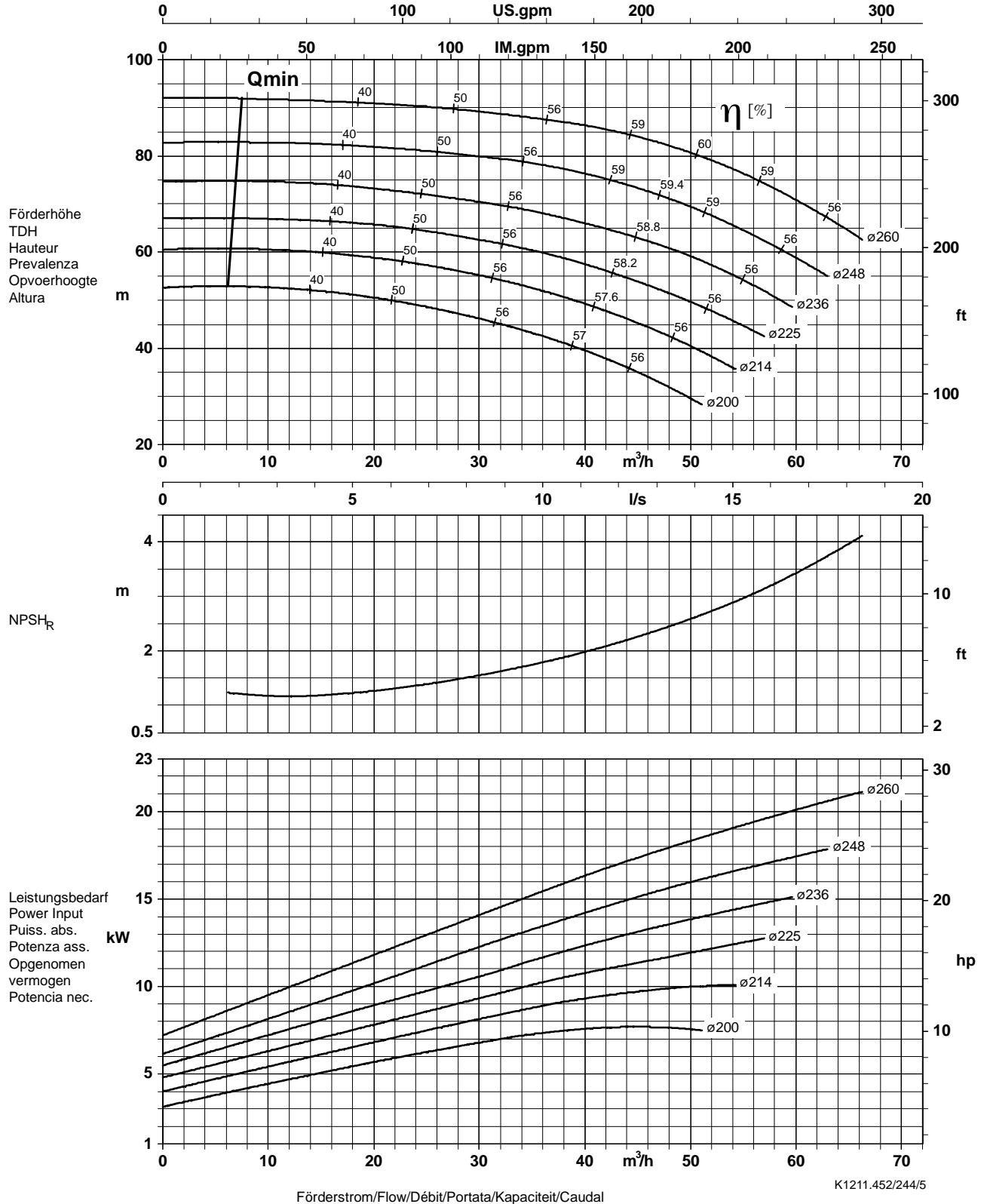

Laufradaustrittsbreite/Impeller outlet width/Largeur à la sortie de la roue 8,0 mm
 Luce della girante/Waaier uitredbreedte/Anchura de salida rodete 8,0 mm

K1211.452/244/5

Baureihe-Größe Type-Size Modèle	Tipo Serie Tipo	Nennzahl Nom. speed Vitesse nom.	Velocità di rotazione nom. Nominaal toerental Revoluciones nom.	Laufrad-ø Impeller Dia. Diamètre de roue	ø Girante ø Waaier ø Rodete	 KSB Aktiengesellschaft Unternehmensbereich Pumpen Industrie- und Wassertechnik Postfach 1725, 67225 Frankenthal Joh.-Klein-Str. 9, 67227 Frankenthal
Etanorm 50-125 Etabloc		2900 1/min				
Projekt Project Projet	Progetto Projekt Proyecto	Angebots-Nr. Project No. No. de l'offre	Offerta-No. Offertenr. Offerta-No.	Pos.-Nr. Item No. No. de pos.	Pos.-Nr. Positiën. Pos.-Nr.	

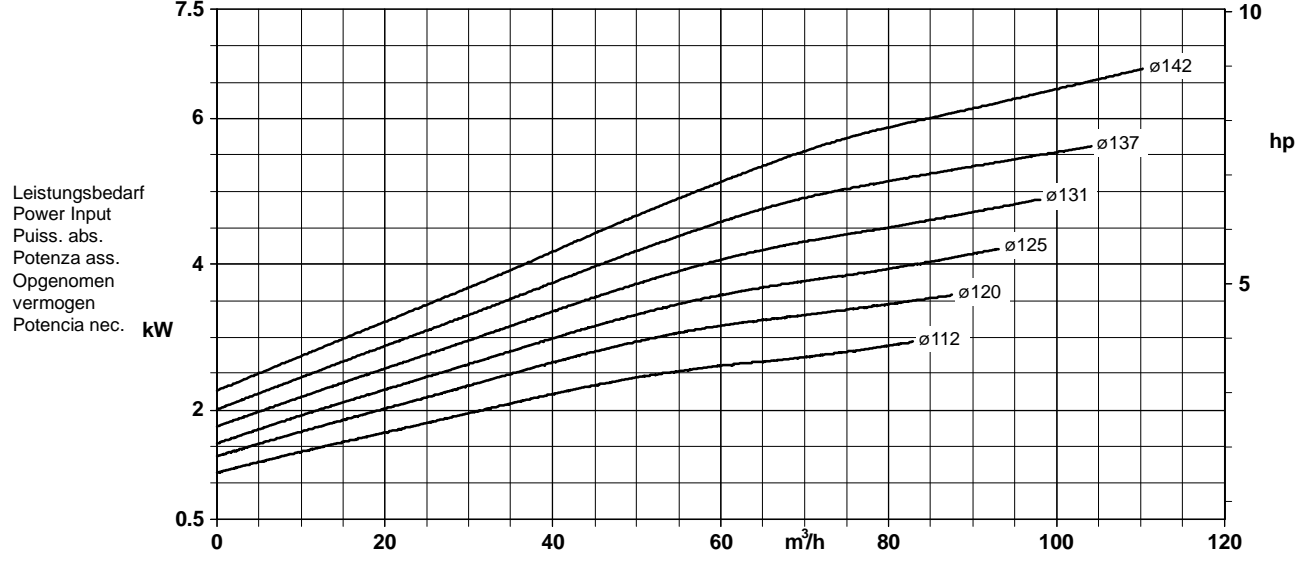
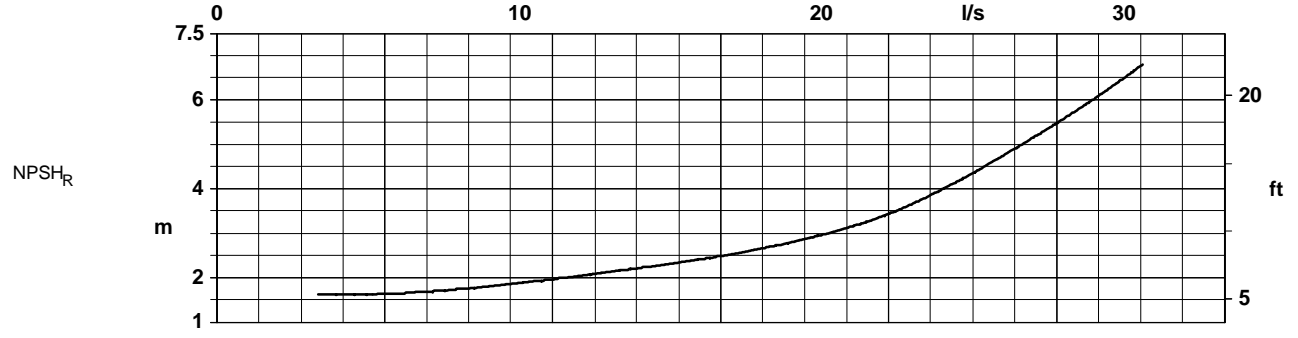
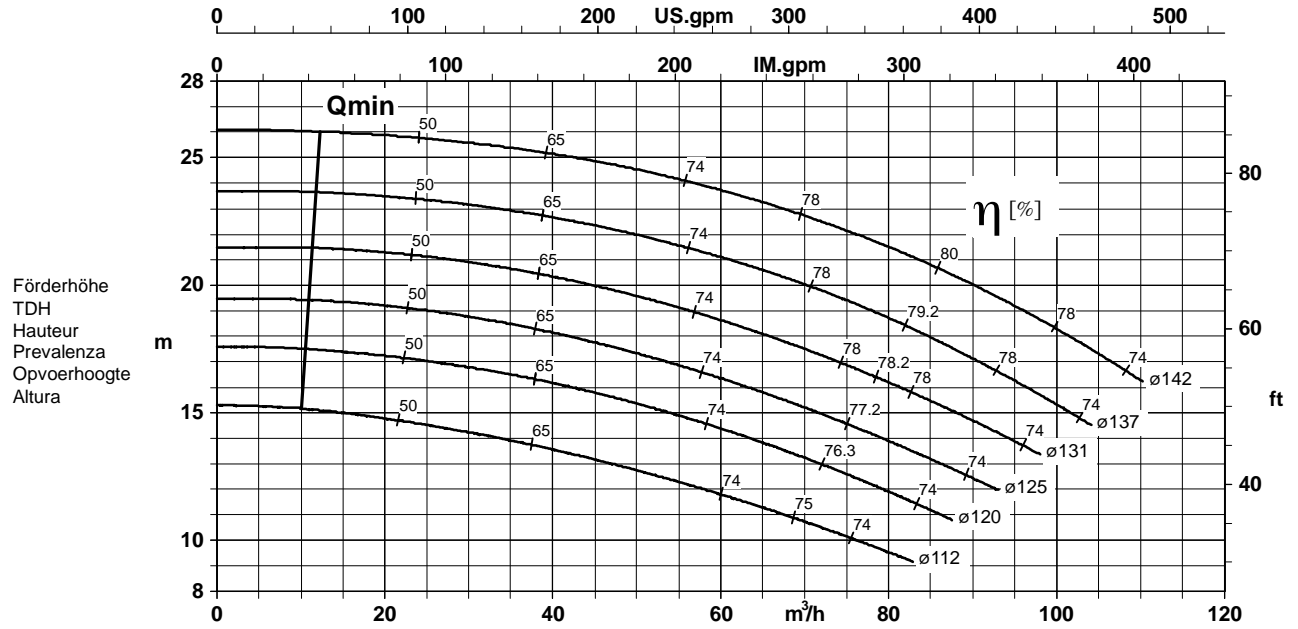

Förderstrom/Flow/Débit/Portata/Kapazität/Caudal

K1211.452/281/5

Laufradaustrittsbreite/Impeller outlet width/Largeur à la sortie de la roue 20,5 mm
 Luce della girante/Waaier uittredbreedte/Anchura de salida rodete 20,5 mm

Baureihe-Größe Type-Size Modèle	Tipo Serie Tipo	Nennzahl Nom. speed Vitesse nom.	Velocità di rotazione nom. Nominaal toerental Revoluciones nom.	Laufrad-ø Impeller Dia. Diamètre de roue	ø Girante ø Waaier ø Rodete	 KSB Aktiengesellschaft Unternehmensbereich Pumpen Industrie- und Wassertechnik Postfach 1725, 67225 Frankenthal Joh.-Klein-Str. 9, 67227 Frankenthal
Etanorm 50-160 Etabloc		2900 1/min				
Projekt Project Projet	Progetto Projekt Proyecto	Angebots-Nr. Project No. No. de l'offre	Offerta-No. Offertenr. Offerta-No.	Pos.-Nr. Item No. No. de pos.	Pos.-Nr. Positiönr. Pos.-Nr.	

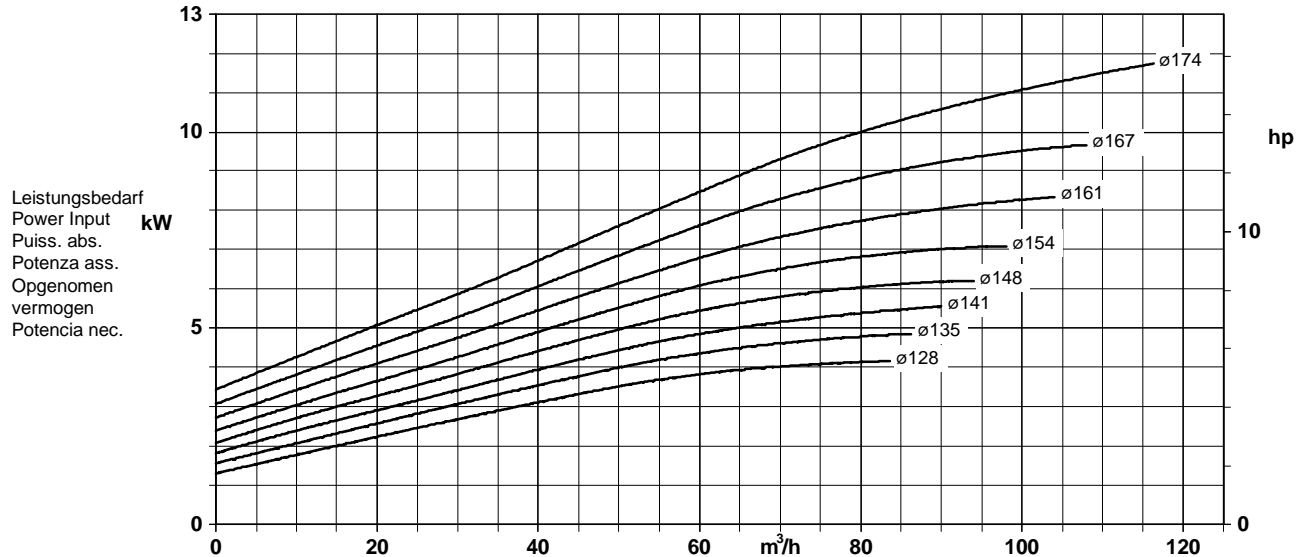
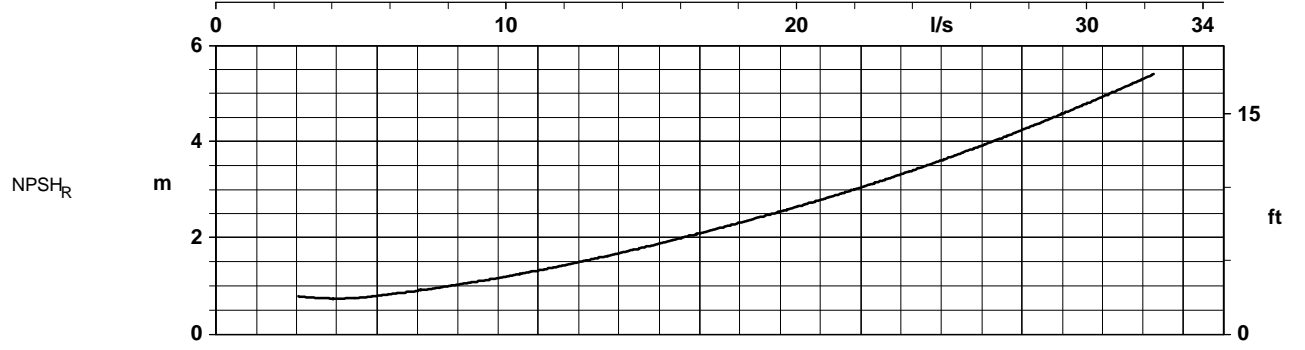
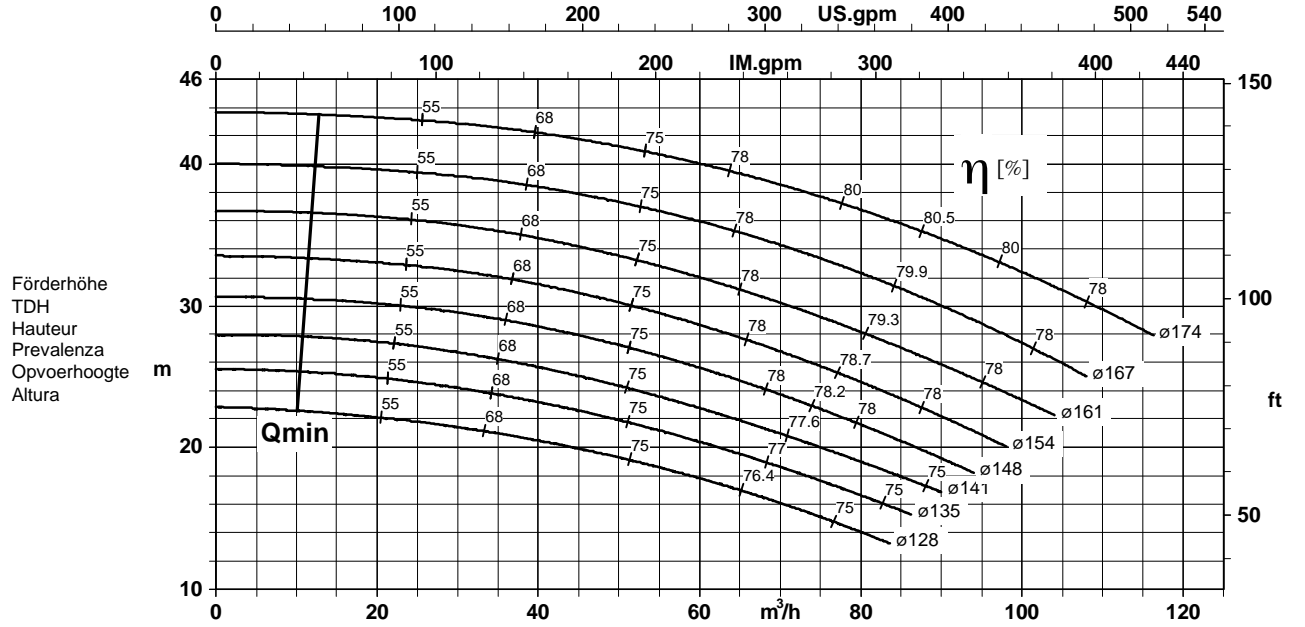

Förderstrom/Flow/Débit/Portata/Kapazität/Caudal

K1211.452/282/5

Laufradaustrittsbreite/Impeller outlet width/Largeur à la sortie de la roue 16,0 mm
 Luce della girante/Waaier uitredbreedte/Anchura de salida rodete 16,0 mm

Baureihe-Größe Type-Size Modèle	Tipo Serie Tipo	Neendrehzahl Nom. speed Vitesse nom.	Velocità di rotazione nom. Nominaal toerental Revoluciones nom.	Laufrad-ø Impeller Dia. Diamètre de roue	ø Girante ø Waaier ø Rodete	 KSB Aktiengesellschaft Unternehmensbereich Pumpen Industrie- und Wassertechnik Postfach 1725, 67225 Frankenthal Joh.-Klein-Str. 9, 67227 Frankenthal
Etanorm 50-200 Etabloc		2900 1/min				
Projekt Project Projet	Progetto Projekt Proyecto	Angebots-Nr. Project No. No. de l'offre	Offerta-No. Offertenr. Offerta-No.	Pos.-Nr. Item No. No. de pos.	Pos.-Nr. Positiënt. Pos.-Nr.	

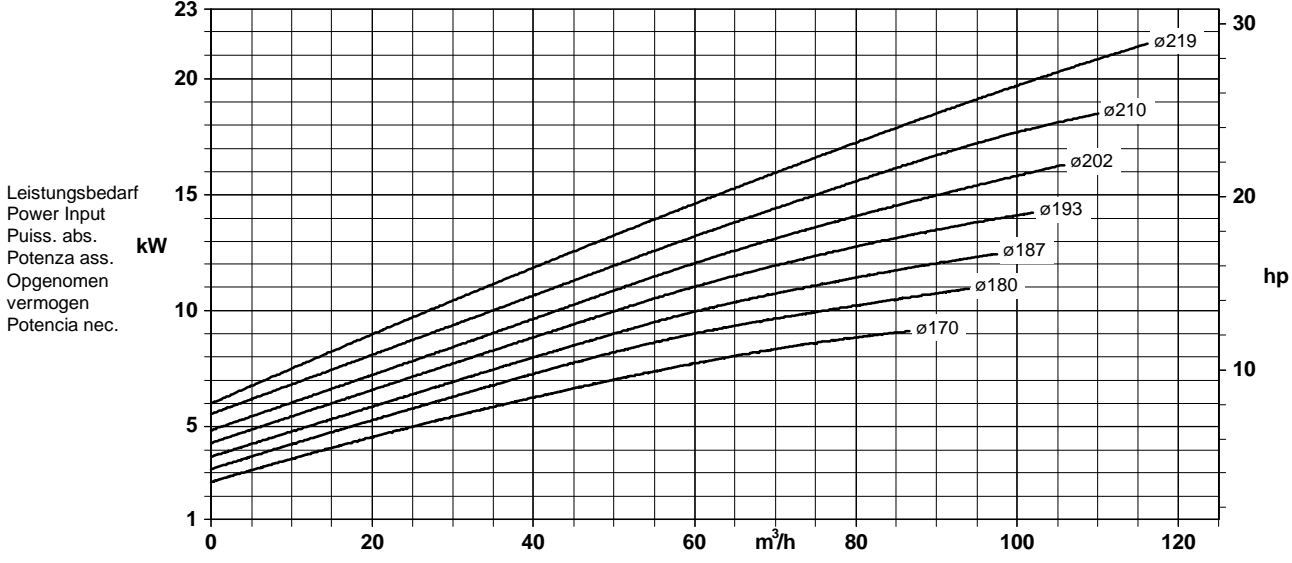
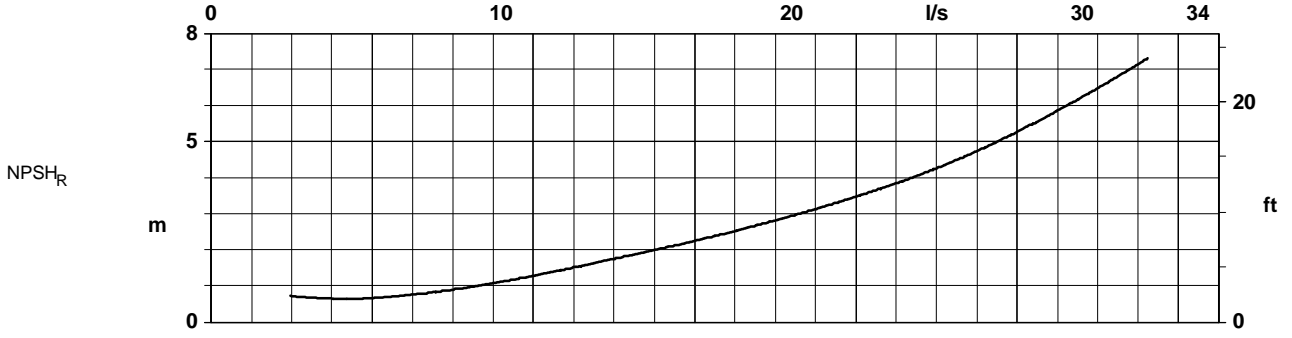
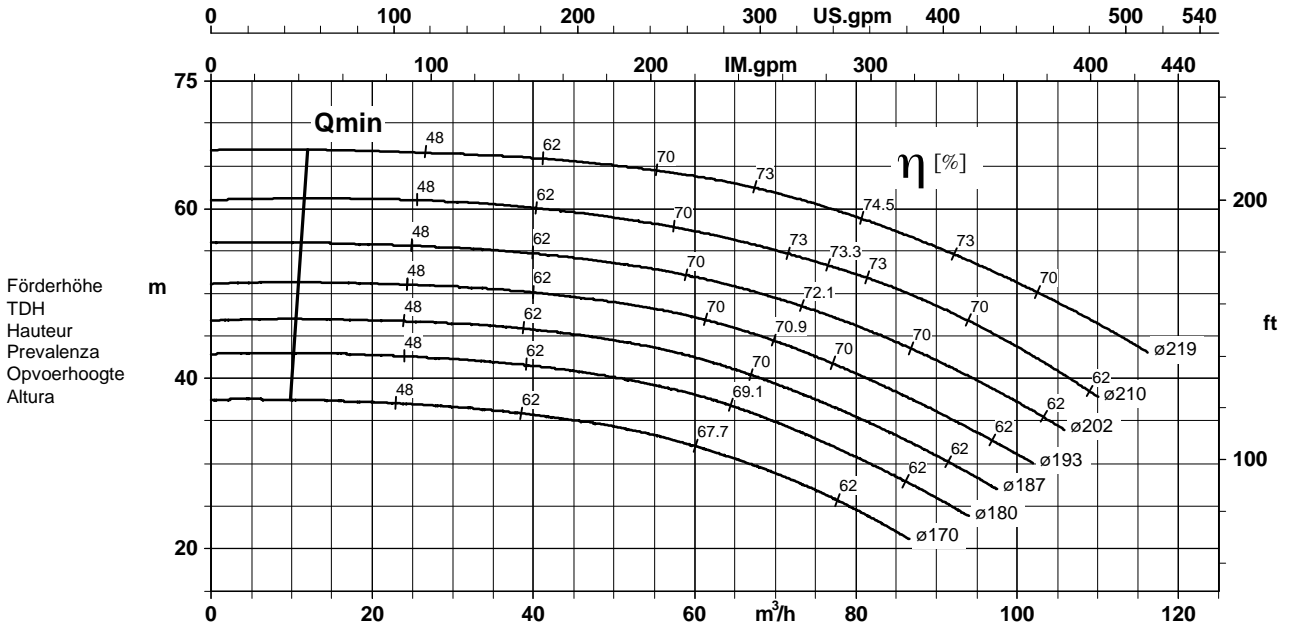

Förderstrom/Flow/Débit/Portata/Kapaciteit/Caudal K1211.452/283/6

Laufradaustrittsbreite/Impeller outlet width/Largeur à la sortie de la roue 11,5 mm
 Luce della girante/Waaier uittredebreedte/Anchura de salida rodete 11,5 mm

Baureihe-Größe Type-Size Modèle	Tipo Serie Tipo	Nennzahl Nom. speed Vitesse nom.	Velocità di rotazione nom. Nominaal toerental Revoluciones nom.	Laufgrad-Ø Impeller Dia. Diamètre de roue	Ø Girante Ø Waaier Ø Rodete	 KSB Aktiengesellschaft Unternehmensbereich Pumpen Industrie- und Wassertechnik Postfach 1725, 67225 Frankenthal Joh.-Klein-Str. 9, 67227 Frankenthal
Etanorm 50-250 Etabloc		2900 1/min				
Projekt Project Projet	Progetto Project Proyecto	Angebots-Nr. Project No. No. de l'offre	Offerta-No. Offertenr. Offerta-No.	Pos.-Nr. Item No. No. de pos.	Pos.-Nr. Positiennr. Pos.-Nr.	

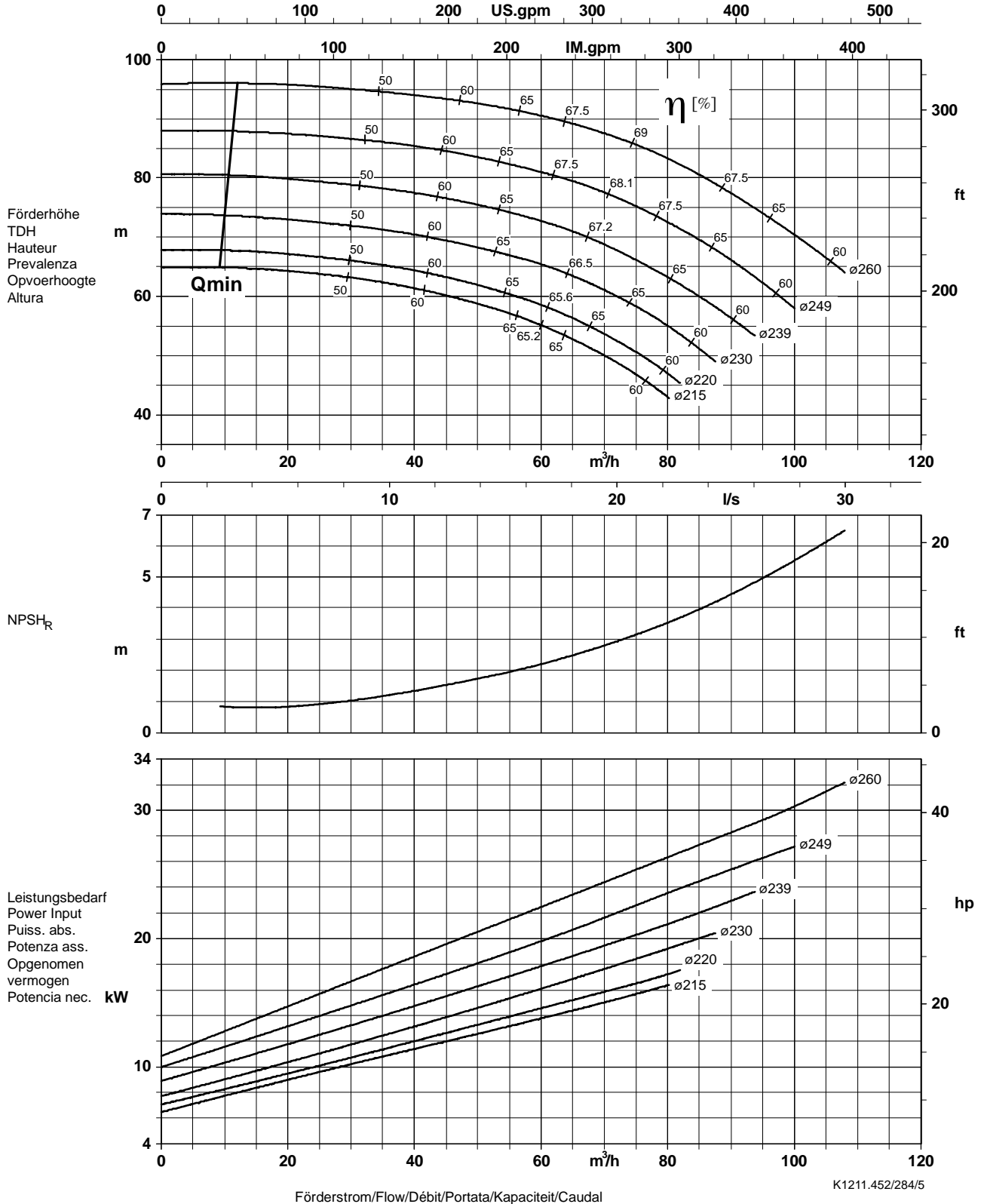

Laufradaustrittsbreite/Impeller outlet width/Largeur à la sortie de la roue 12,0 mm
 Luce della girante/Waaier uitredbreedte/Anchura de salida rodete 12,0 mm

Baureihe-Größe Type-Size Modèle	Tipo Serie Tipo	Neendrehzahl Nom. speed Vitesse nom.	Velocità di rotazione nom. Nominaal toerental Revoluciones nom.	Laufrad-ø Impeller Dia. Diamètre de roue	ø Girante ø Waaier ø Rodete	 KSB Aktiengesellschaft Unternehmensbereich Pumpen Industrie- und Wassertechnik Postfach 1725, 67225 Frankenthal Joh.-Klein-Str. 9, 67227 Frankenthal
Etanorm 65-125 Etabloc		2900 1/min				
Projekt Project Projet	Progetto Projekt Proyecto	Angebots-Nr. Project No. No. de l'offre	Offerta-No. Offertenr. Offerta-No.	Pos.-Nr. Item No. No. de pos.	Pos.-Nr. Positiën. Pos.-Nr.	

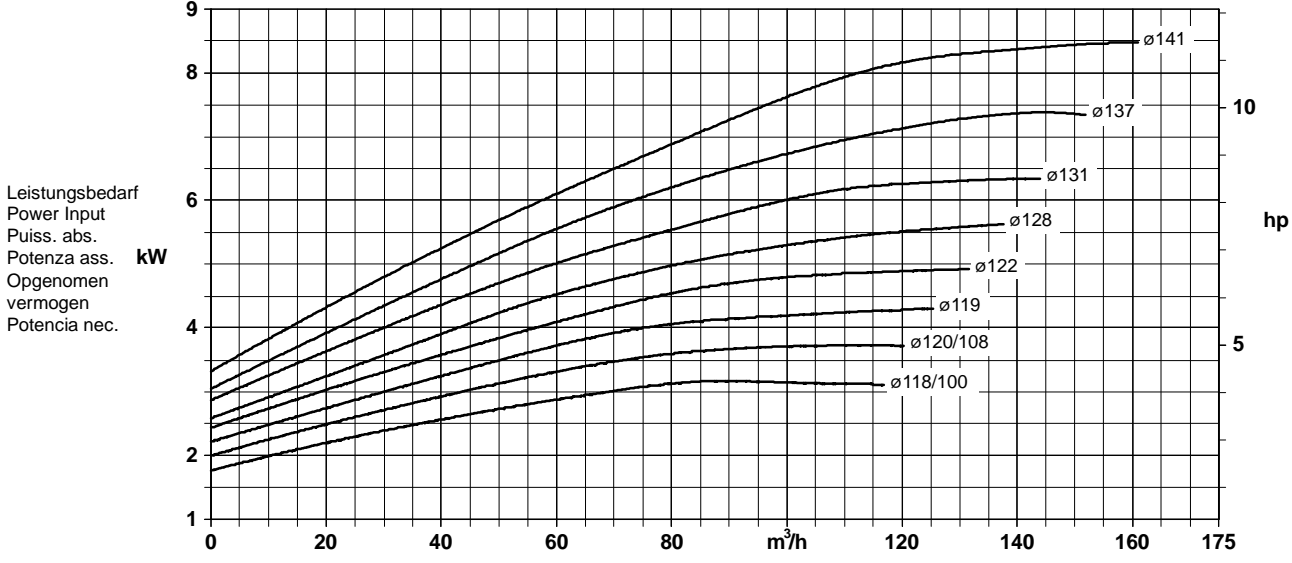
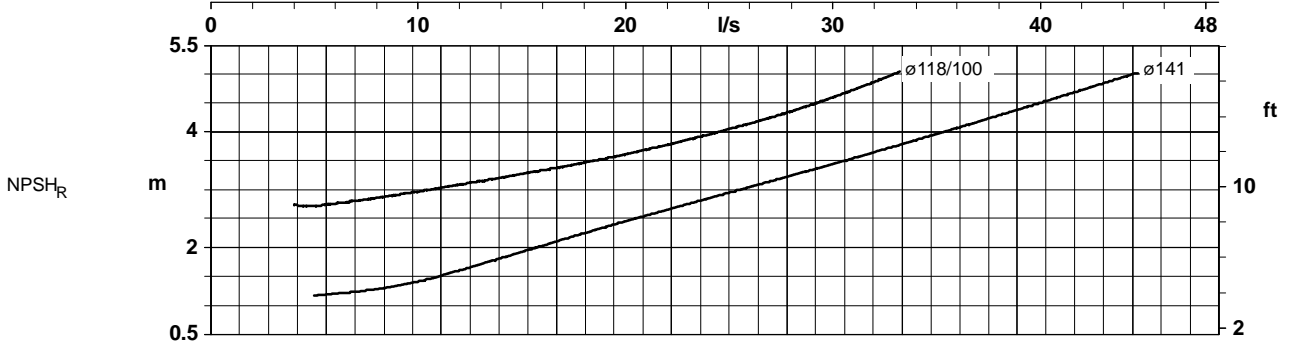
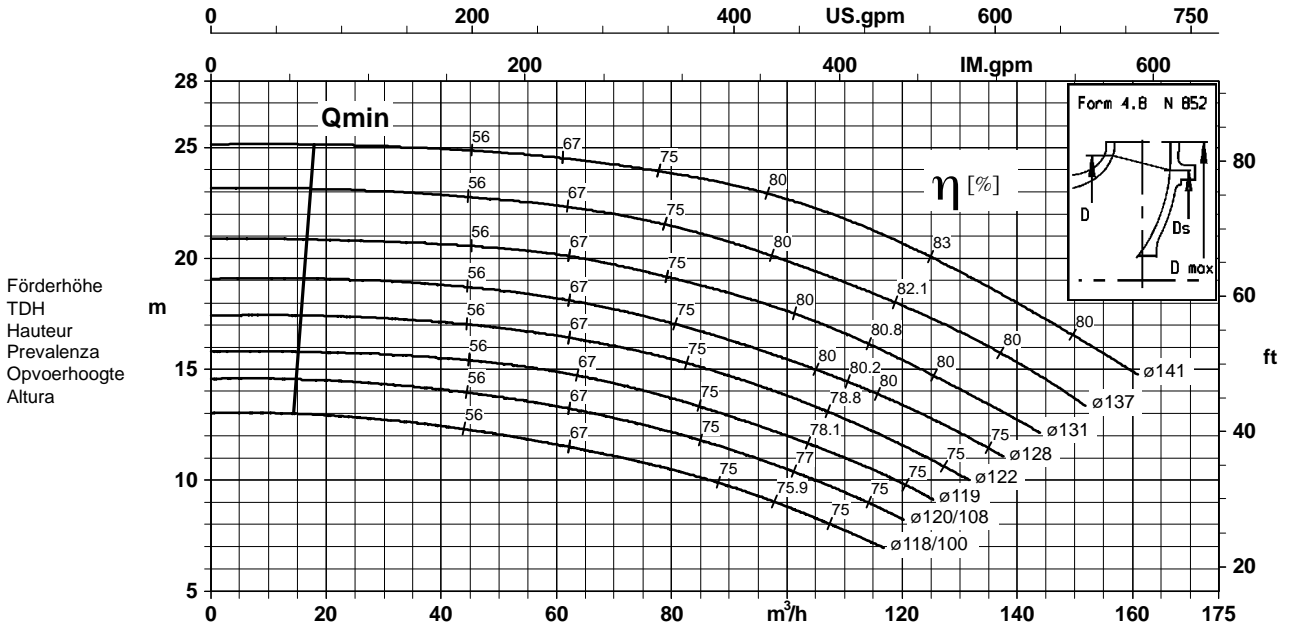

Förderstrom/Flow/Débit/Portata/Kapaciteit/Caudal
 K1211.452/311/5
 Laufradaustrittsbreite/Impeller outlet width/Largeur à la sortie de la roue 25,6 mm
 Luce della girante/Waaier uittebreedte/Anchura de salida rodete 25,6 mm

Baureihe-Größe Type-Size Modèle	Tipo Serie Tipo	Nennzahl Nom. speed Vitesse nom.	Velocità di rotazione nom. Nominaal toerental Revoluciones nom.	Laufrad-ø Impeller Dia. Diamètre de roue	ø Girante ø Waaier ø Rodete
Etanorm 65-160 Etabloc		2900 1/min			
Projekt Project Projet	Progetto Projekt Proyecto	Angebots-Nr. Project No. No. de l'offre	Offerta-No. Offertenr. Offerta-No.	Pos.-Nr. Item No. No. de pos.	Pos.-Nr. Positiën. Pos.-Nr.
 <p>KSB Aktiengesellschaft Unternehmensbereich Pumpen Industrie- und Wassertechnik Postfach 1725, 67225 Frankenthal Joh.-Klein-Str. 9, 67227 Frankenthal</p>					

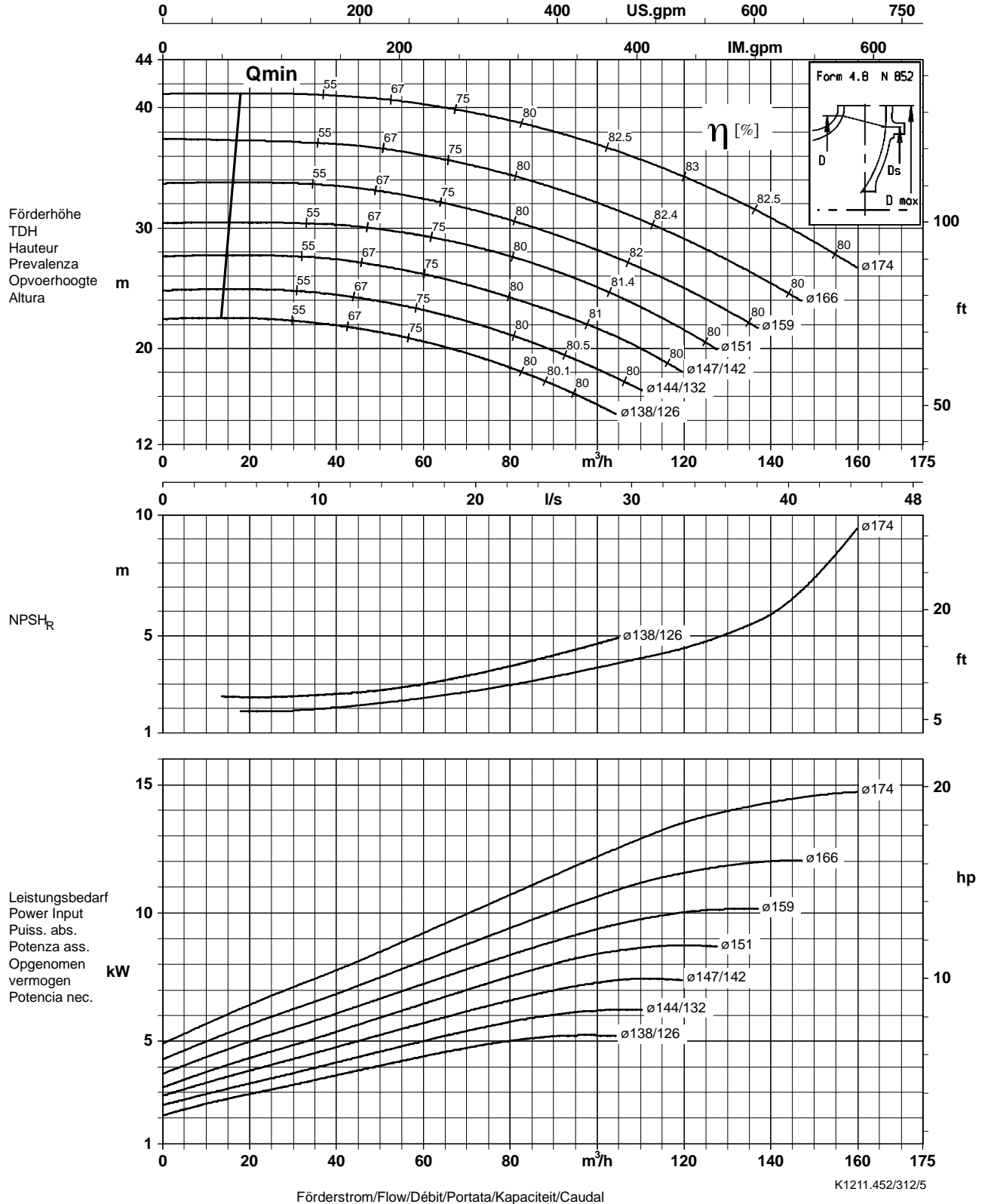

Lauftradaustrittsbreite/Impeller outlet width/Largeur à la sortie de la roue 21,0 mm
 Luce della girante/Waaier uitredbreedte/Anchura de salida rodete 21,0 mm

Baureihe-Größe Type-Size Modèle	Tipo Serie Tipo	Neendrehzahl Nom. speed Vitesse nom.	Velocità di rotazione nom. Nominaal toerental Revoluciones nom.	Laufrad-ø Impeller Dia. Diamètre de roue	ø Girante ø Waaier ø Rodete	 KSB Aktiengesellschaft Unternehmensbereich Pumpen Industrie- und Wassertechnik Postfach 1725, 67225 Frankenthal Joh.-Klein-Str. 9, 67227 Frankenthal
Etanorm 65-200 Etabloc		2900 1/min				
Projekt Project Projet	Progetto Projekt Proyecto	Angebots-Nr. Project No. No. de l'offre	Offerta-No. Offertenr. Offerta-No.	Pos.-Nr. Item No. No. de pos.	Pos.-Nr. Positient. Pos.-Nr.	

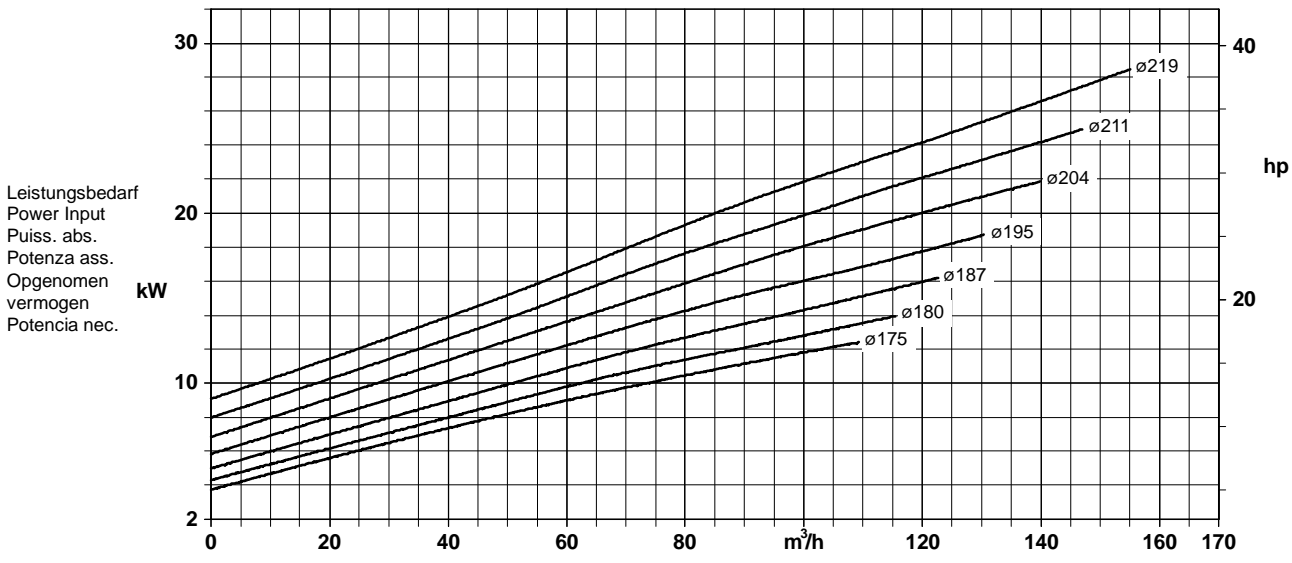
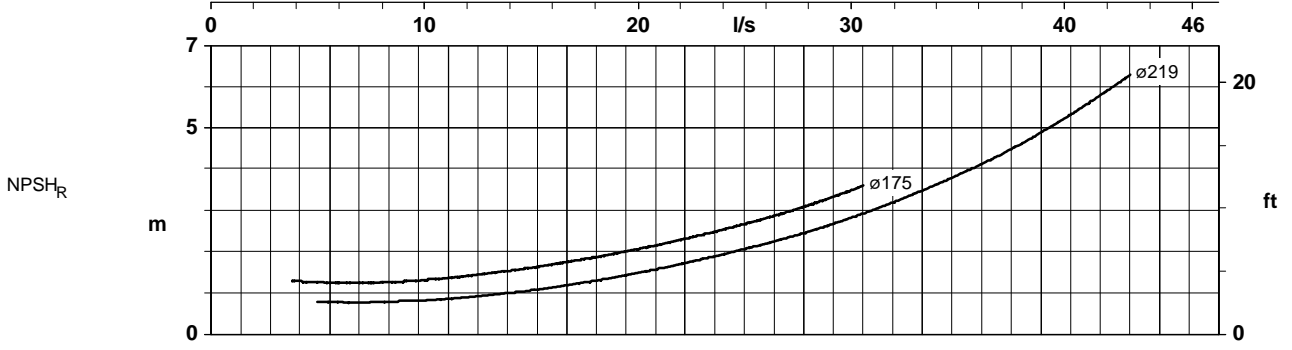
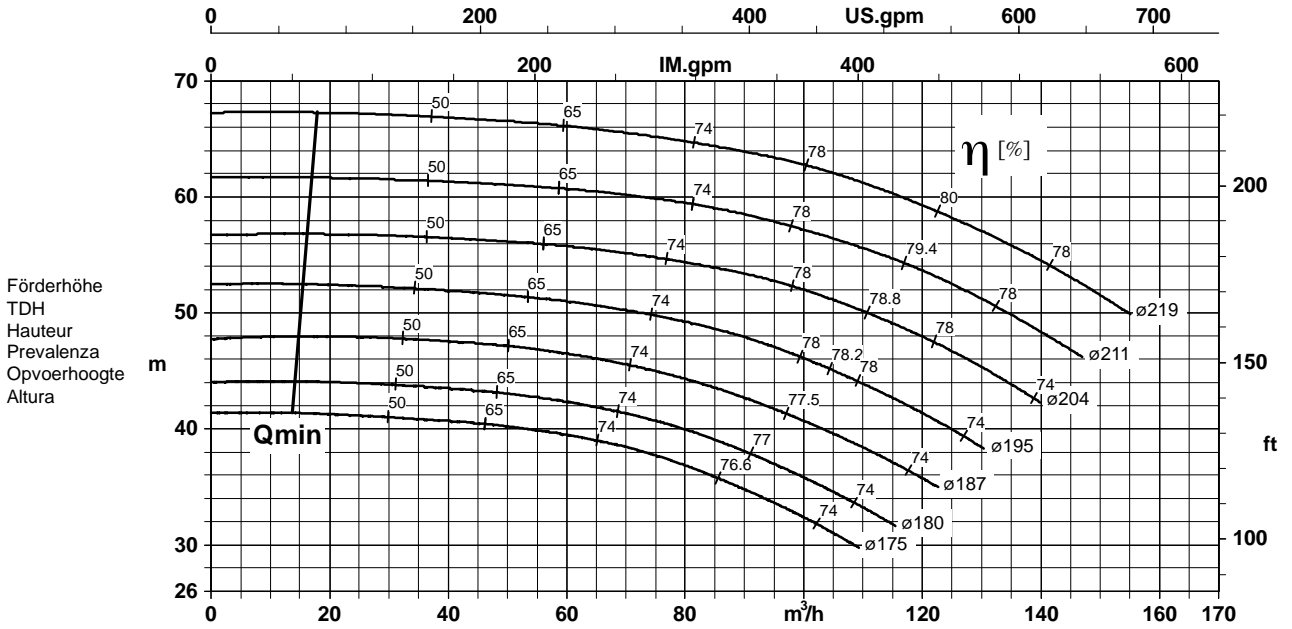

Förderstrom/Flow/Débit/Portata/Kapaciteit/Caudal
 K1211.452/313/5
 Laufradaustrittsbreite/Impeller outlet width/Largeur à la sortie de la roue 17,0 mm
 Luce della girante/Waaier uittredebreedte/Anchura de salida rodete 17,0 mm

Baureihe-Größe Type-Size Modèle	Tipo Serie Tipo	Nennzahl Nom. speed Vitesse nom.	Velocità di rotazione nom. Nominaal toerental Revoluciones nom.	Lauf-rad-ø Impeller Dia. Diamètre de roue	ø Girante ø Waaier ø Rodete	 KSB Aktiengesellschaft Unternehmensbereich Pumpen Industrie- und Wassertechnik Postfach 1725, 67225 Frankenthal Joh.-Klein-Str. 9, 67227 Frankenthal
Etanorm 65-250 Etabloc		2900 1/min				
Projekt Project Projet	Progetto Projekt Proyecto	Angebots-Nr. Project No. No. de l'offre	Offerta-No. Offertenr. Offerta-No.	Pos.-Nr. Item No. No. de pos.	Pos.-Nr. Positiennr. Pos.-Nr.	

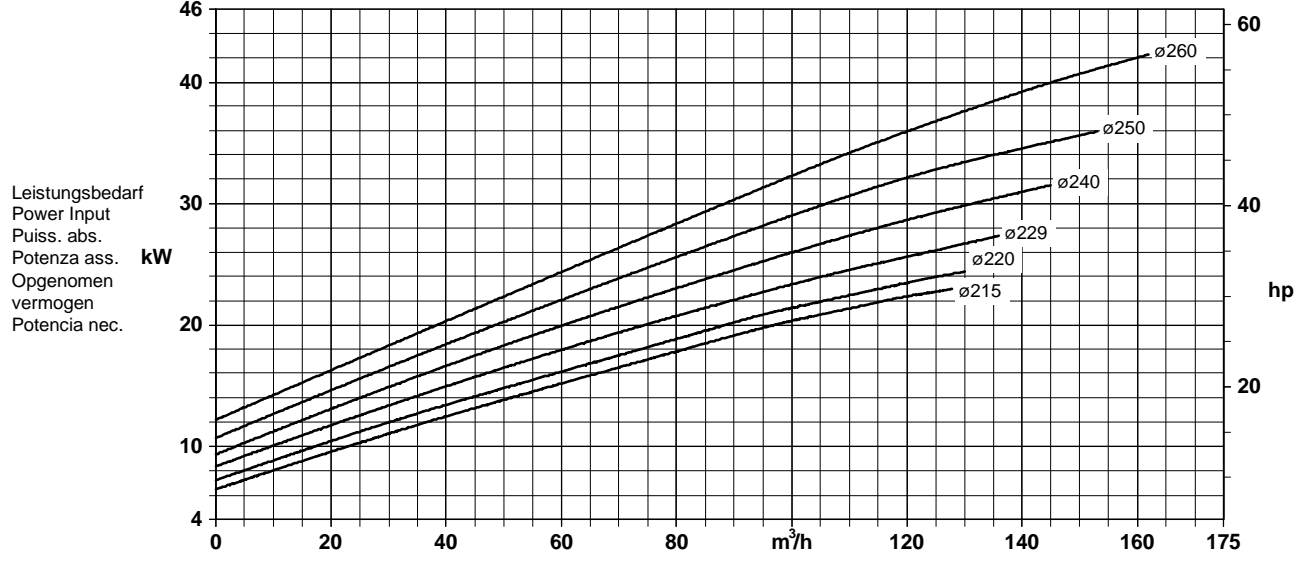
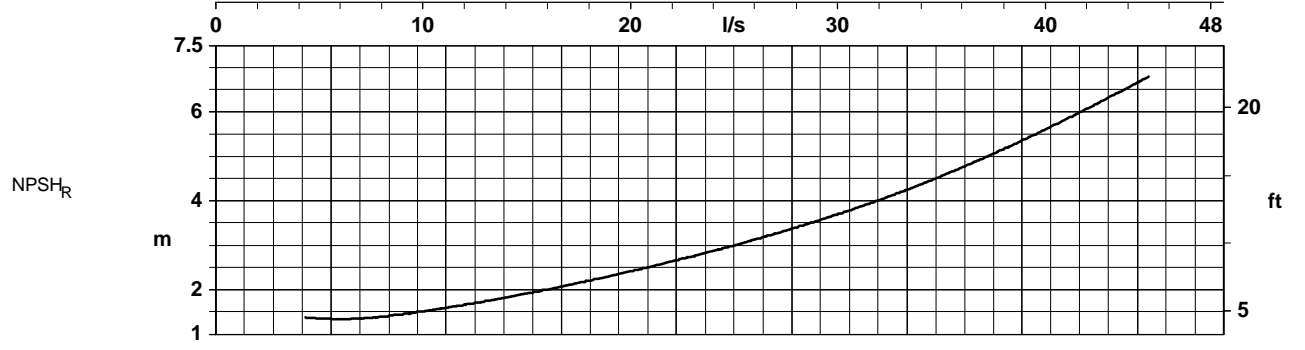
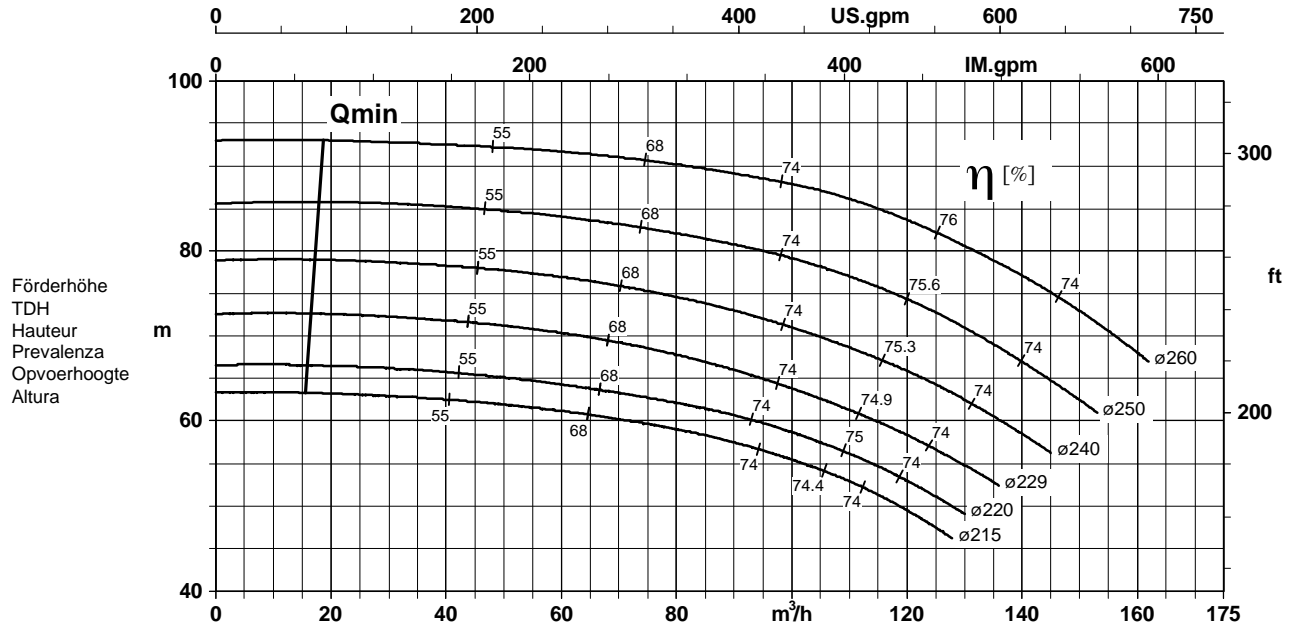

Förderstrom/Flow/Débit/Portata/Kapazität/Caudal

Laufradaustrittsbreite/Impeller outlet width/Largeur à la sortie de la roue 13,9 mm
 Luce della girante/Waaier uitredbreedte/Anchura de salida rodete 13,9 mm

K1211.452/324/5

Baureihe-Größe Type-Size Modèle	Tipo Serie Tipo	Neendrehzahl Nom. speed Vitesse nom.	Velocità di rotazione nom. Nominaal toerental Revoluciones nom.	Laufrad-ø Impeller Dia. Diamètre de roue	ø Girante ø Waaier ø Rodete	 KSB Aktiengesellschaft Unternehmensbereich Pumpen Industrie- und Wassertechnik Postfach 1725, 67225 Frankenthal Joh.-Klein-Str. 9, 67227 Frankenthal
Etanorm 80-160 Etabloc		2900 1/min				
Projekt Project Projet	Progetto Projekt Proyecto	Angebots-Nr. Project No. No. de l'offre	Offerta-No. Offertenr. Offerta-No.	Pos.-Nr. Item No. No. de pos.	Pos.-Nr. Positiëntr. Pos.-Nr.	

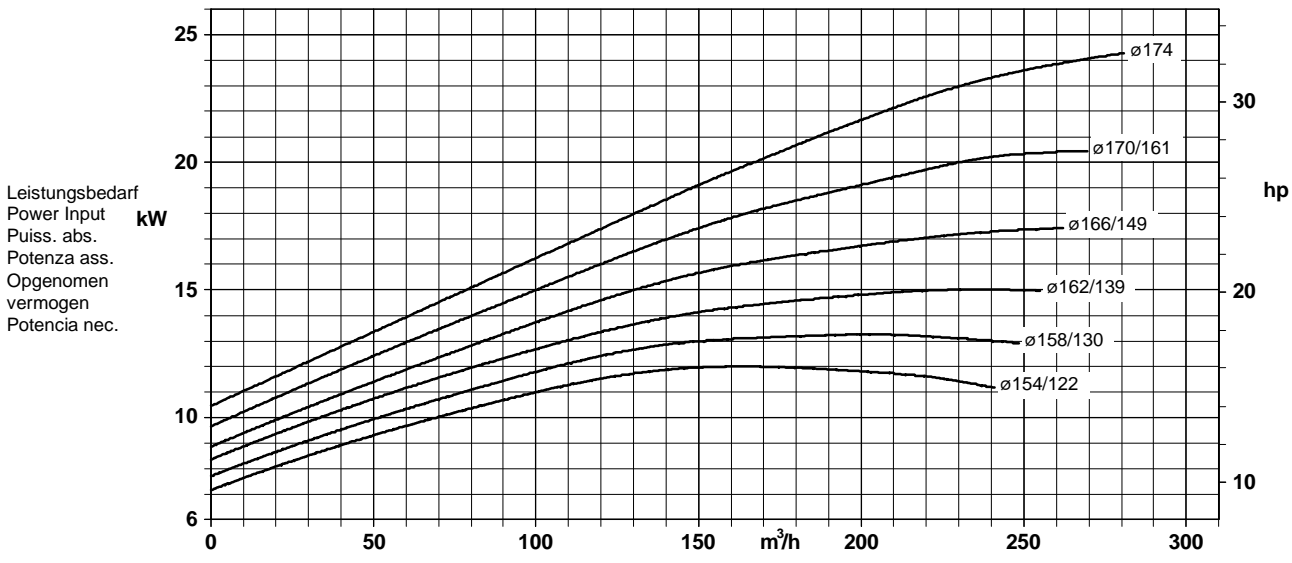
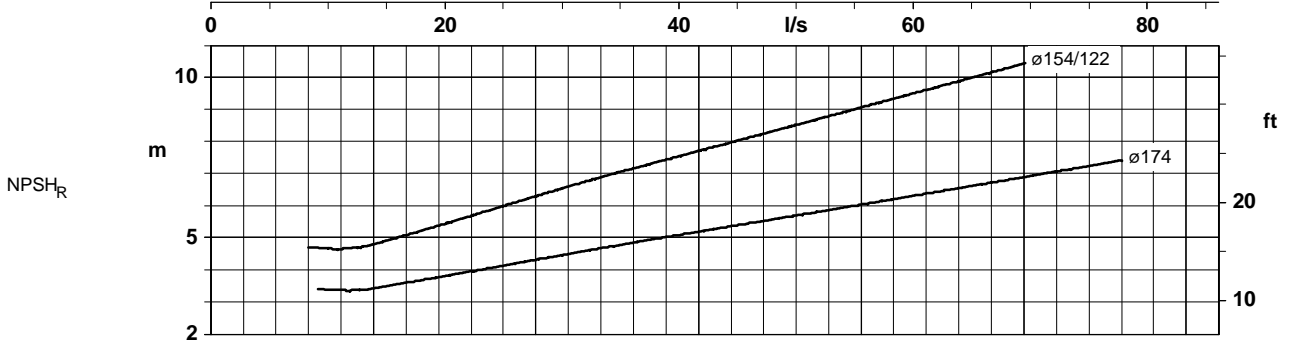
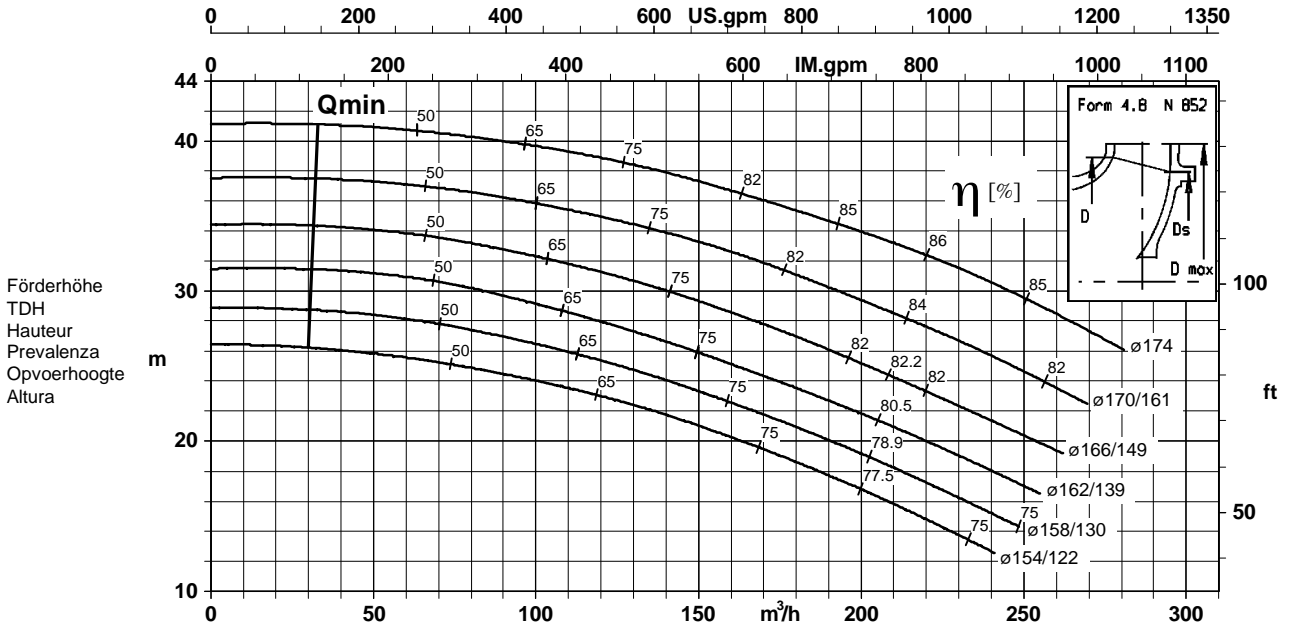

Förderstrom/Flow/Débit/Portata/Kapaciteit/Caudal

K1211.452/362/5

Laufradaustrittsbreite/Impeller outlet width/Largeur à la sortie de la roue 31,6 mm
 Luce della girante/Waaier uittredebreedte/Anchura de salida rodete 31,6 mm

Baureihe-Größe Type-Size Modèle	Tipo Serie Tipo	Nenn Drehzahl Nom. speed Vitesse nom.	Velocità di rotazione nom. Nominaal toerental Revoluciones nom.	Lauf rad- \emptyset Impeller Dia. Diamètre de roue	\emptyset Girante \emptyset Waaier \emptyset Rodete	 <p>KSB Aktiengesellschaft Unternehmensbereich Pumpen Industrie- und Wassertechnik Postfach 1725, 67225 Frankenthal Joh.-Klein-Str. 9, 67227 Frankenthal</p>
Etanorm 80-200 Etabloc		2900 1/min				
Projekt Project Projet	Progetto Projekt Proyecto	Angebots-Nr. Project No. No. de l'offre	Offerta-No. Offertenr. Offerta-No.	Pos.-Nr. Item No. No. de pos.	Pos.-Nr. Positiennr. Pos.-Nr.	

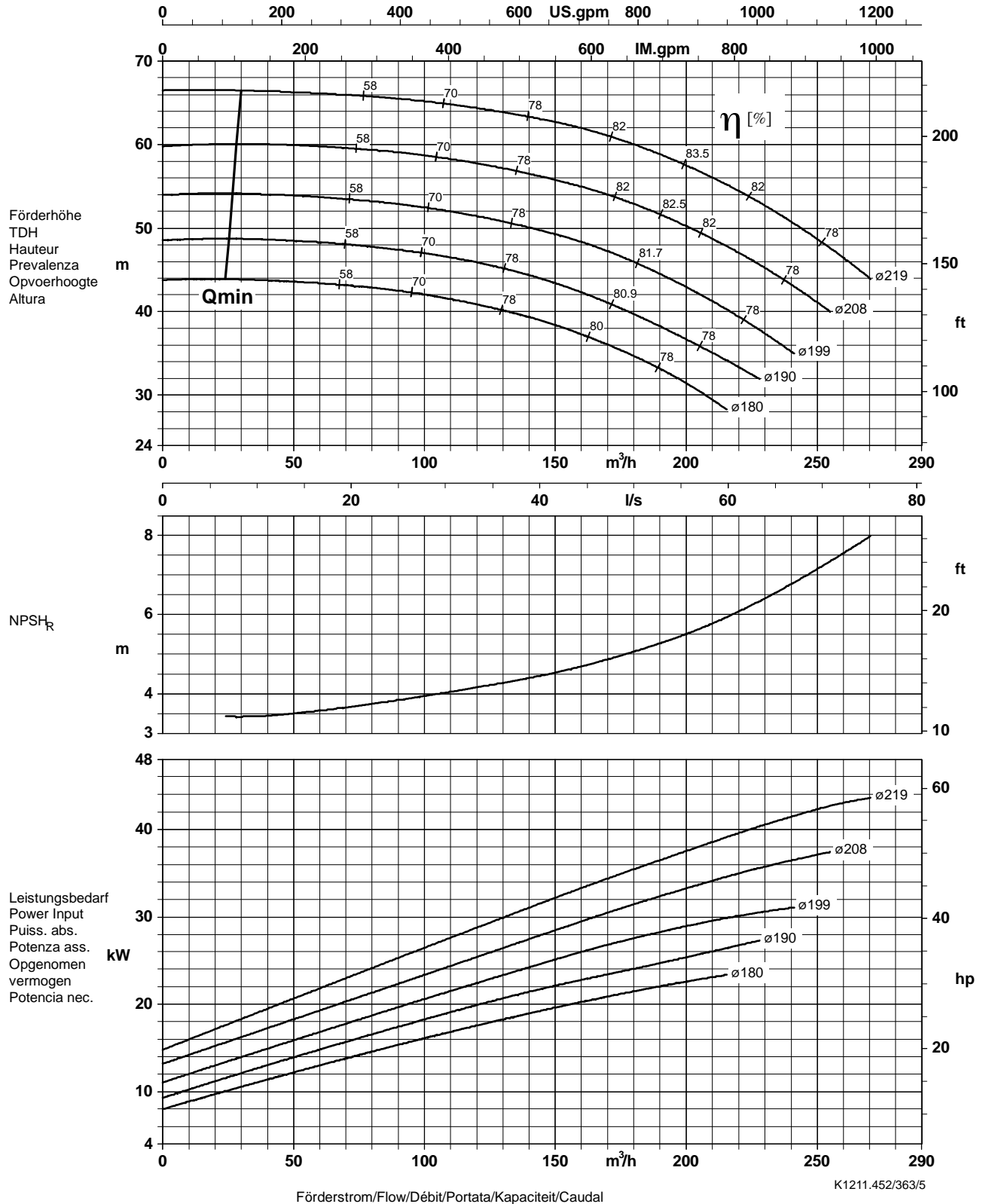

Lauftradaustrittsbreite/Impeller outlet width/Largeur à la sortie de la roue 23,5 mm
Luce della girante/Waaier uittredebreedte/Anchura de salida rodete 23,5 mm

Baureihe-Größe Type-Size Modèle	Tipo Serie Tipo	Neendrehzahl Nom. speed Vitesse nom.	Velocità di rotazione nom. Nominaal toerental Revoluciones nom.	Laufrad-ø Impeller Dia. Diamètre de roue	ø Girante ø Waaier ø Rodete	 KSB Aktiengesellschaft Unternehmensbereich Pumpen Industrie- und Wassertechnik Postfach 1725, 67225 Frankenthal Joh.-Klein-Str. 9, 67227 Frankenthal
Etanorm 80-250 Etabloc		2900 1/min				
Projekt Project Projet	Progetto Projekt Proyecto	Angebots-Nr. Project No. No. de l'offre	Offerta-No. Offertenr. Offerta-No.	Pos.-Nr. Item No. No. de pos.	Pos.-Nr. Positiën. Pos.-Nr.	

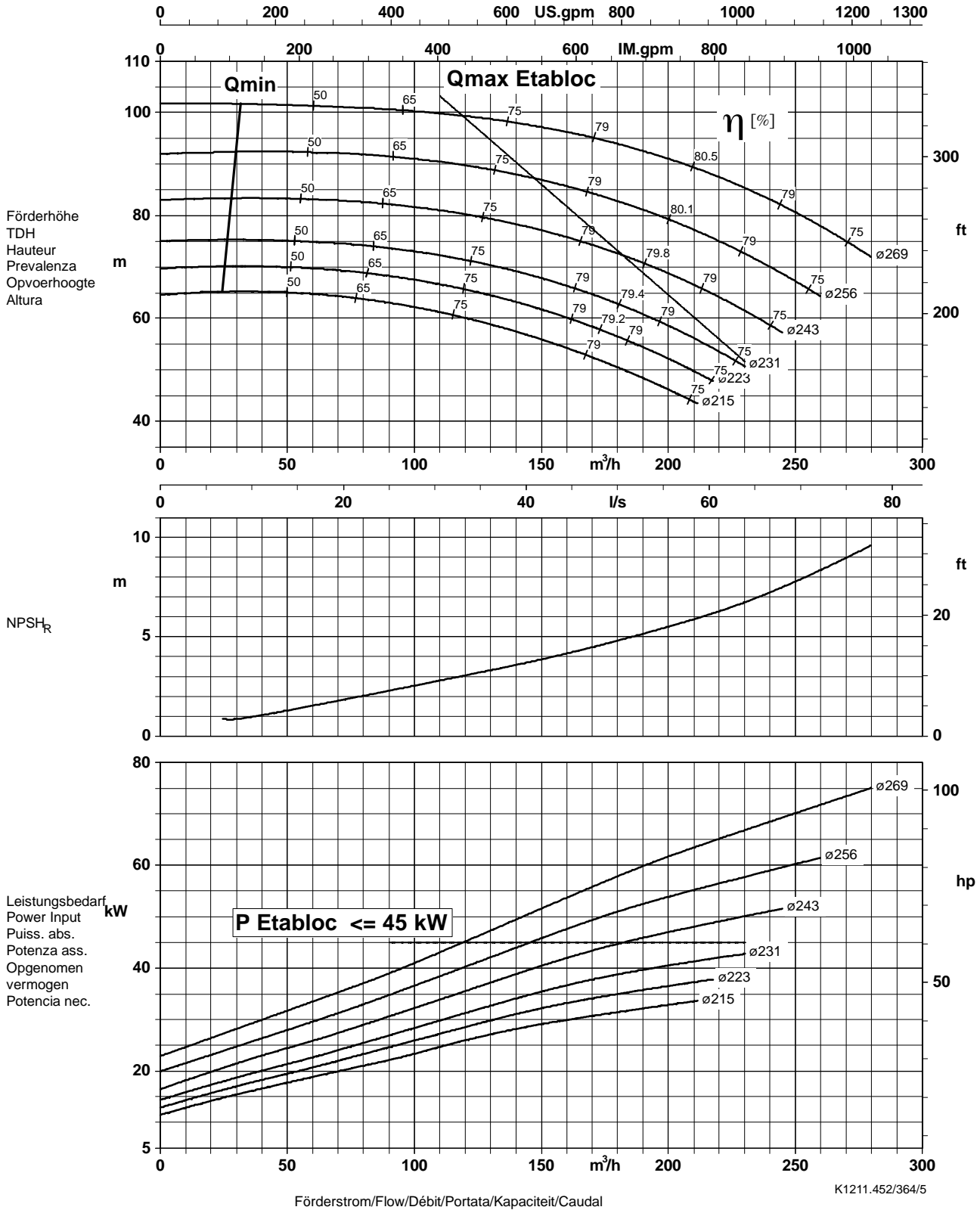

Laufradaustrittsbreite/Impeller outlet width/Largeur à la sortie de la roue 19,0 mm
 Luce della girante/Waaier uittredbreedte/Anchura de salida rodete 19,0 mm

Baureihe-Größe Type-Size Modèle	Tipo Serie Tipo	Nennzahl Nom. speed Vitesse nom.	Velocità di rotazione nom. Nominaal toerental Revoluciones nom.	Laufrad-ø Impeller Dia. Diamètre de roue	ø Girante ø Waaier ø Rodete	 <p>KSB Aktiengesellschaft Unternehmensbereich Pumpen Industrie- und Wassertechnik Postfach 1725, 67225 Frankenthal Joh.-Klein-Str. 9, 67227 Frankenthal</p>
Etanorm 100-160 Etabloc		2900 1/min				
Projekt Project Projet	Progetto Projekt Proyecto	Angebots-Nr. Project No. No. de l'offre	Offerta-No. Offertenr. Offerta-No.	Pos.-Nr. Item No. No. de pos.	Pos.-Nr. Positiennr. Pos.-Nr.	

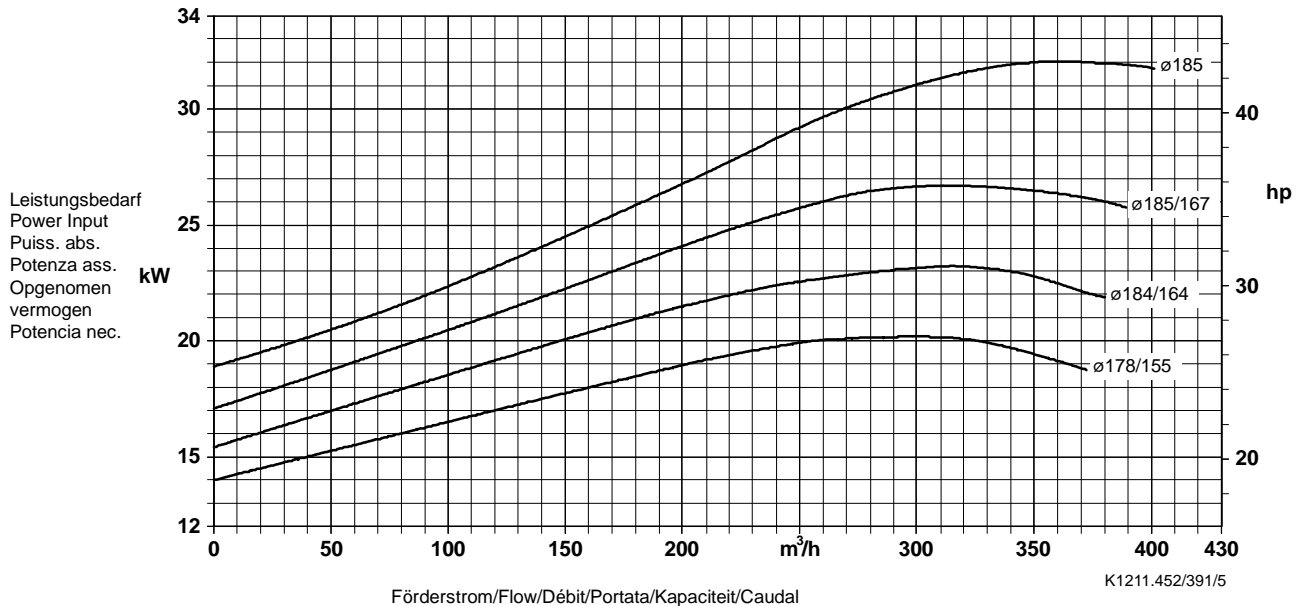
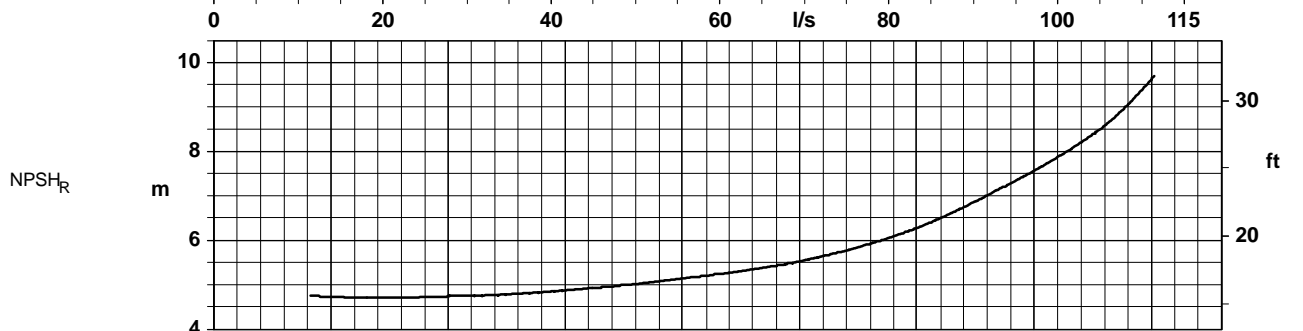
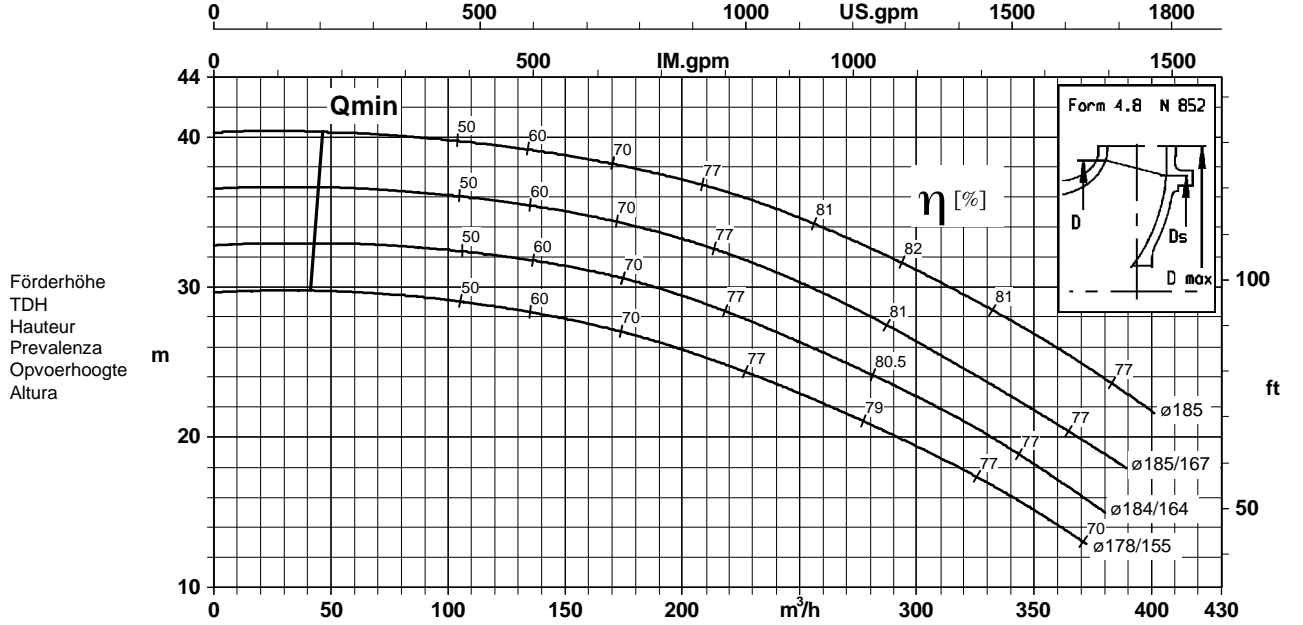

Laufradaustrittsbreite/Impeller outlet width/Largeur à la sortie de la roue 36,0 mm
Luce della girante/Waaier uitredbreedte/Anchura de salida rodete 36,0 mm

Baureihe-Größe Type-Size Modèle	Tipo Serie Tipo	Neendrehzahl Nom. speed Vitesse nom.	Velocità di rotazione nom. Nominaal toerental Revoluciones nom.	Laufrad- ϕ Impeller Dia. Diamètre de roue	ϕ Girante ϕ Waaier ϕ Rodete	 KSB Aktiengesellschaft Unternehmensbereich Pumpen Industrie- und Wassertechnik Postfach 1725, 67225 Frankenthal Joh.-Klein-Str. 9, 67227 Frankenthal
Etanorm 100-200 Etabloc		2900 1/min				
Projekt Project Projet	Progetto Projekt Proyecto	Angebots-Nr. Project No. No. de l'offre	Offerta-No. Offertenr. Offerta-No.	Pos.-Nr. Item No. No. de pos.	Pos.-Nr. Positiën. Pos.-Nr.	

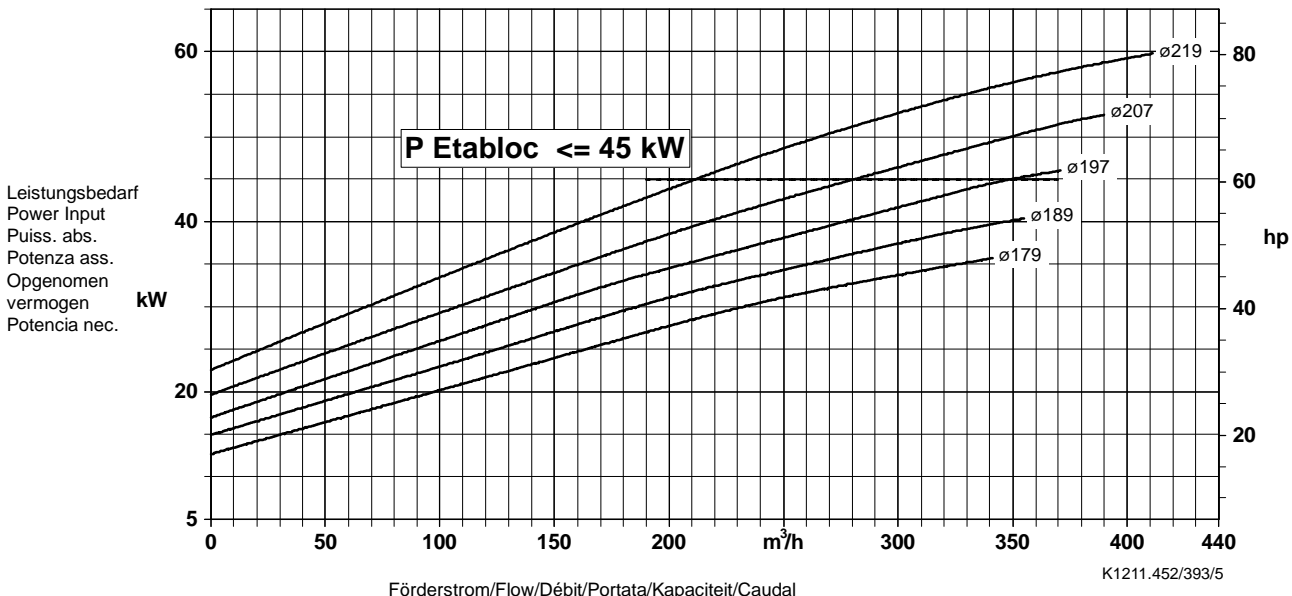
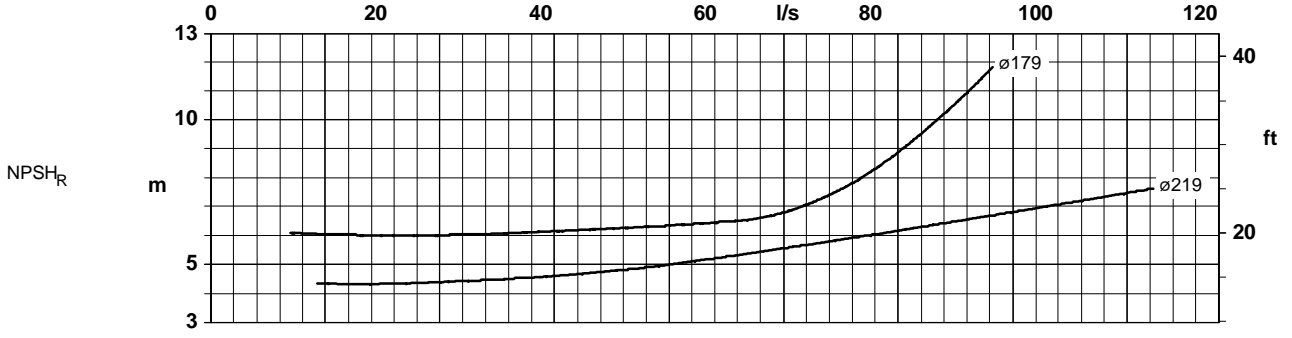
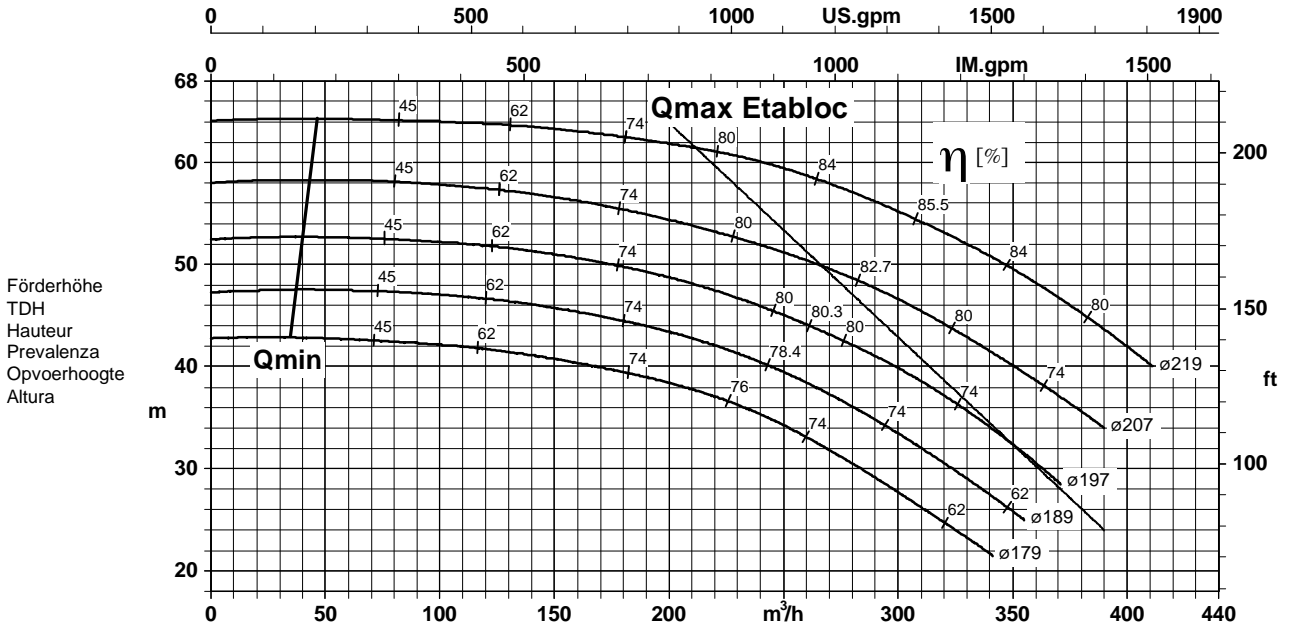

Laufradaustrittsbreite/Impeller outlet width/Largeur à la sortie de la roue 32,5 mm
 Luce della girante/Waaier uittredebreedte/Anchura de salida rodete 32,5 mm

K1211.452/393/5

Baureihe-Größe Type-Size Modèle	Tipo Serie Tipo	Nennzahl Nom. speed Vitesse nom.	Velocità di rotazione nom. Nominaal toerental Revoluciones nom.	Laufgrad-ø Impeller Dia. Diamètre de roue	ø Girante ø Waaier ø Rodete	 KSB Aktiengesellschaft Unternehmensbereich Pumpen Industrie- und Wassertechnik Postfach 1725, 67225 Frankenthal Joh.-Klein-Str. 9, 67227 Frankenthal
Etanorm 100-250		2900 1/min				
Projekt Project Projet	Progetto Projekt Proyecto	Angebots-Nr. Project No. No. de l'offre	Offerta-No. Offertenr. Offerta-No.	Pos.-Nr. Item No. No. de pos.	Pos.-Nr. Positiën. Pos.-Nr.	

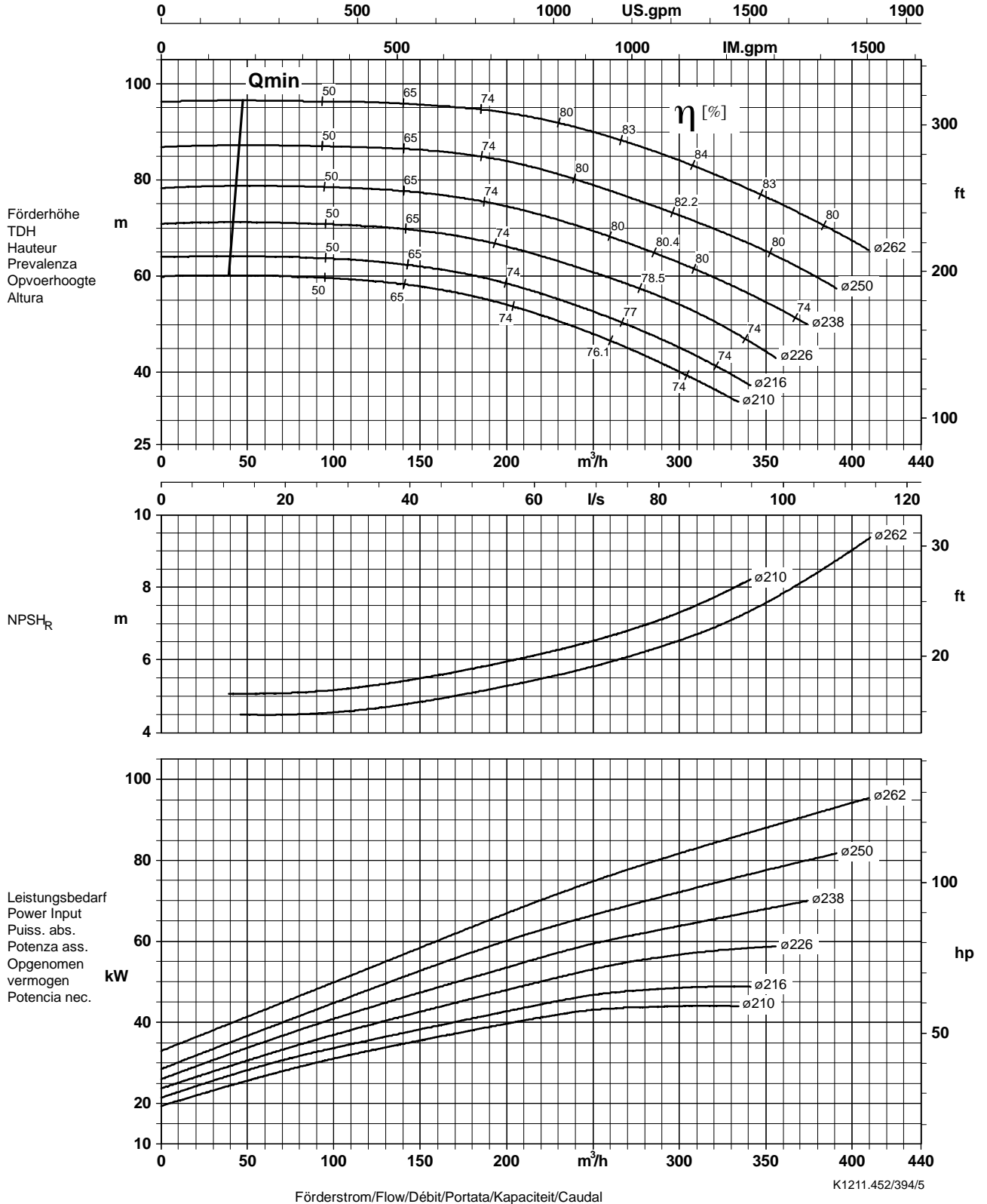

Lauftradaustrittsbreite/Impeller outlet width/Largeur à la sortie de la roue 27,0 mm
 Luce della girante/Waaier uitredbreedte/Anchura de salida rodete 27,0 mm

Baureihe-Größe Type-Size Modèle	Tipo Serie Tipo	Neendrehzahl Nom. speed Vitesse nom.	Velocità di rotazione nom. Nominaal toerental Revoluciones nom.	Laufrad- ϕ Impeller Dia. Diamètre de roue	ϕ Girante ϕ Waaier ϕ Rodete	 KSB Aktiengesellschaft Unternehmensbereich Pumpen Industrie- und Wassertechnik Postfach 1725, 67225 Frankenthal Joh.-Klein-Str. 9, 67227 Frankenthal
Etanorm 125-200		2900 1/min				
Projekt Project Projet	Progetto Projekt Proyecto	Angebots-Nr. Project No. No. de l'offre	Offerta-No. Offertenr. Offerta-No.	Pos.-Nr. Item No. No. de pos.	Pos.-Nr. Positiënt. Pos.-Nr.	

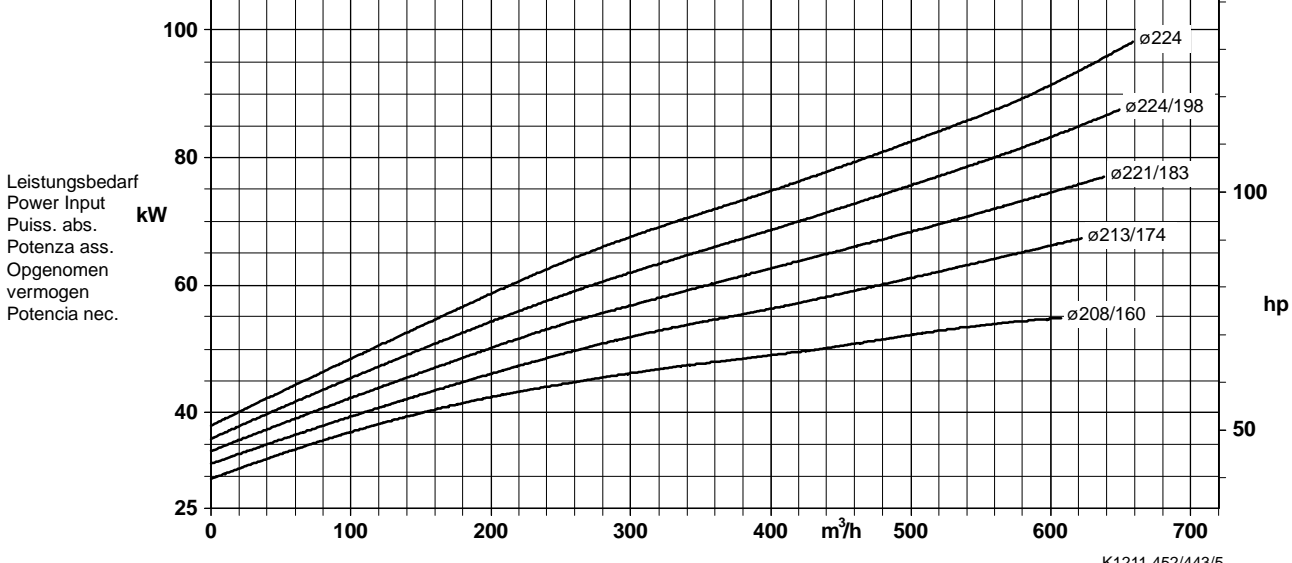
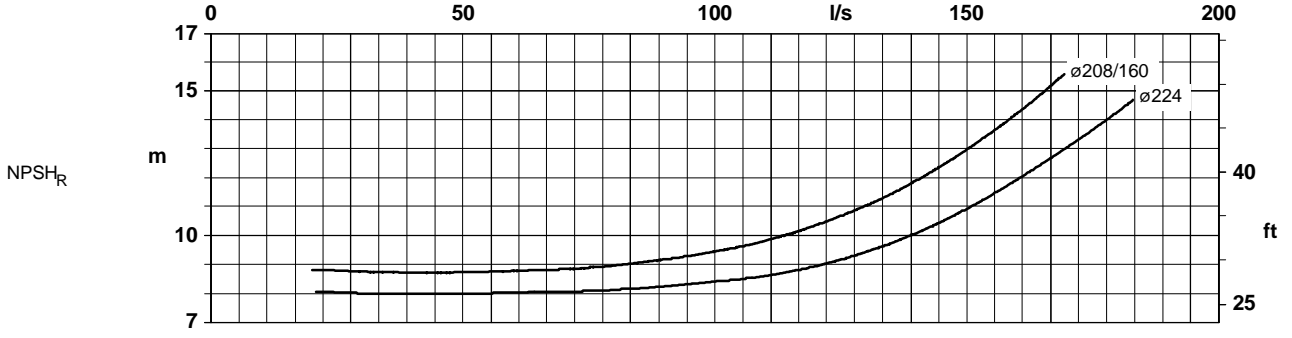
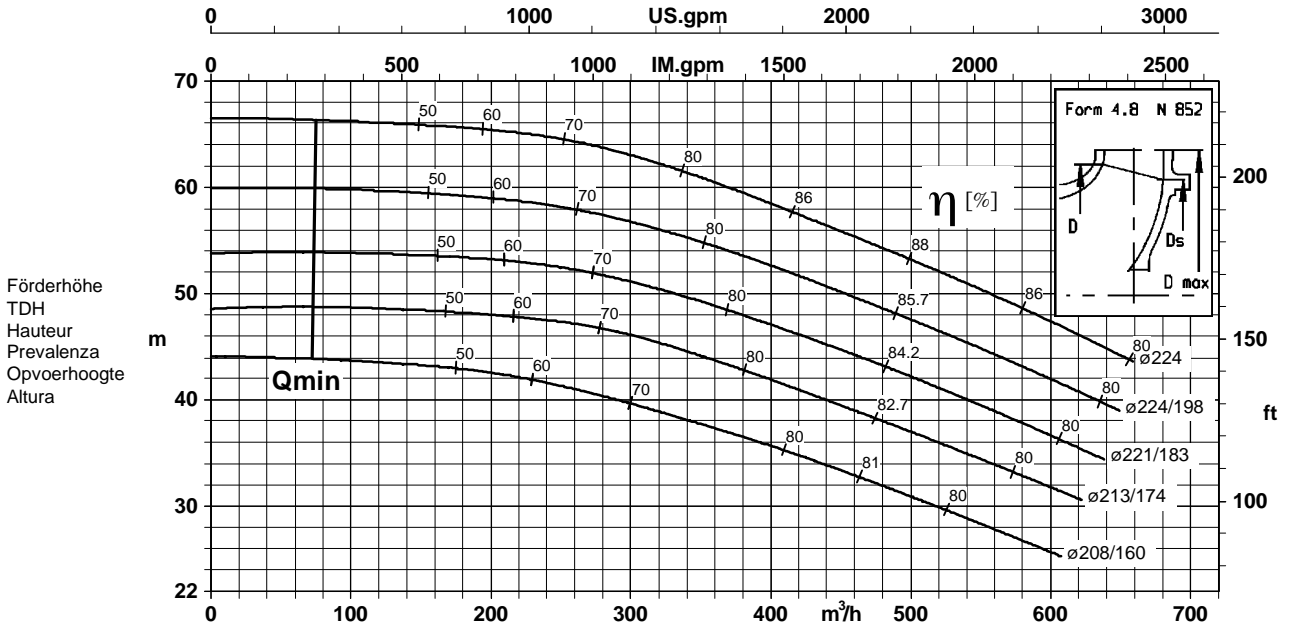



Förderstrom/Flow/Débit/Portata/Kapaciteit/Caudal

K1211.452/443/5

Laufradaustrittsbreite/Impeller outlet width/Largeur à la sortie de la roue 40,7 mm
 Luce della girante/Waaier uittredebreedte/Anchura de salida rodete 40,7 mm

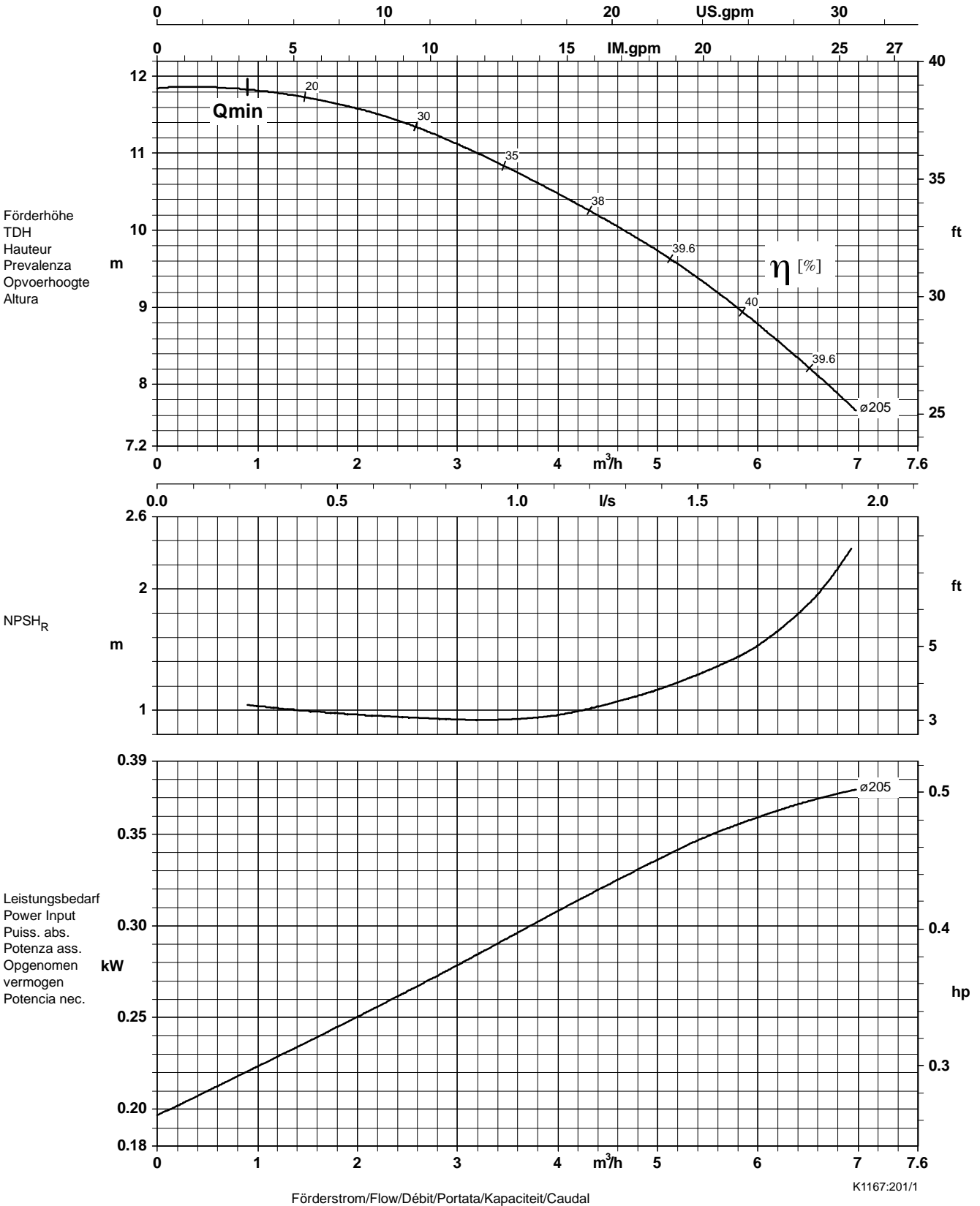
Baureihe-Größe Type-Size Modèle	Tipo Serie Tipo	Nenn Drehzahl Nom. speed Vitesse nom.	Velocità di rotazione nom. Nominaal toerental Revoluciones nom.	Lauf rad- \varnothing Impeller Dia. Diamètre de roue	\varnothing Girante \varnothing Waaier \varnothing Rodete	 KSB Aktiengesellschaft Unternehmensbereich Pumpen Industrie- und Wassertechnik Postfach 1725, 67225 Frankenthal Joh.-Klein-Str. 9, 67227 Frankenthal
Etabloc 25-20		1450 1/min		205 mm		
Projekt Project Projet	Progetto Projekt Proyecto	Angebots-Nr. Project No. No. de l'offre	Offerta-No. Offertenr. Offerta-No.	Pos.-Nr. Item No. No. de pos.	Pos.-Nr. Positiën. Pos.-Nr.	



Baureihe-Größe Type-Size Modèle	Tipo Serie Tipo	Neendrehzahl Nom. speed Vitesse nom.	Velocità di rotazione nom. Nominaal toerental Revoluciones nom.	Laufrad-ø Impeller Dia. Diamètre de roue	ø Girante ø Waaier ø Rodete	 KSB Aktiengesellschaft Unternehmensbereich Pumpen Industrie- und Wassertechnik Postfach 1725, 67225 Frankenthal Joh.-Klein-Str. 9, 67227 Frankenthal
Etanorm 32-125.1 Etabloc		1450 1/min				
Projekt Project Projet	Progetto Projekt Proyecto	Angebots-Nr. Project No. No. de l'offre	Offerta-No. Offertenr. Offerta-No.	Pos.-Nr. Item No. No. de pos.	Pos.-Nr. Positiën. Pos.-Nr.	

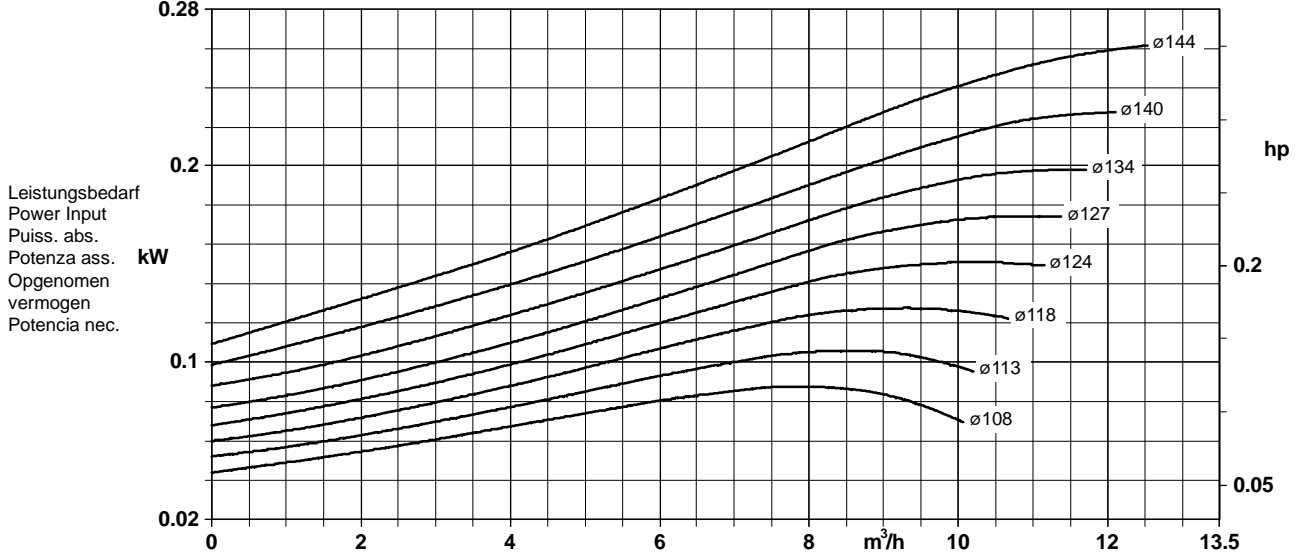
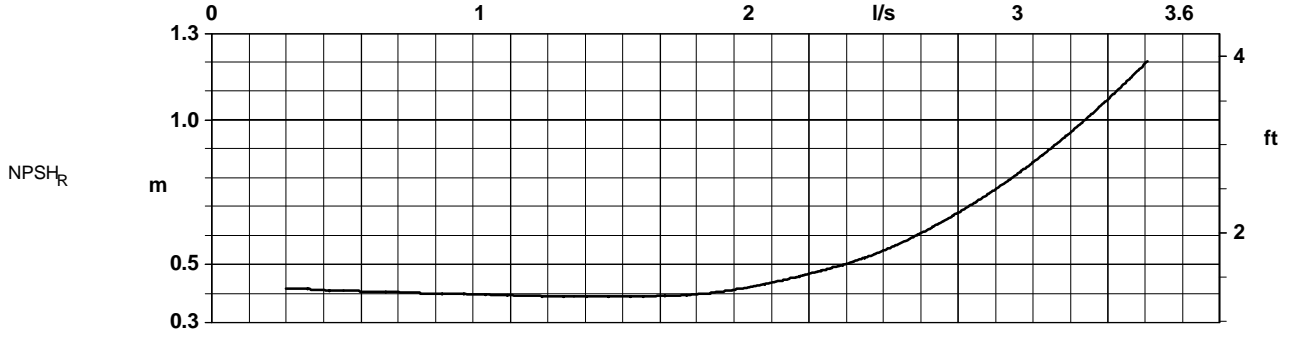
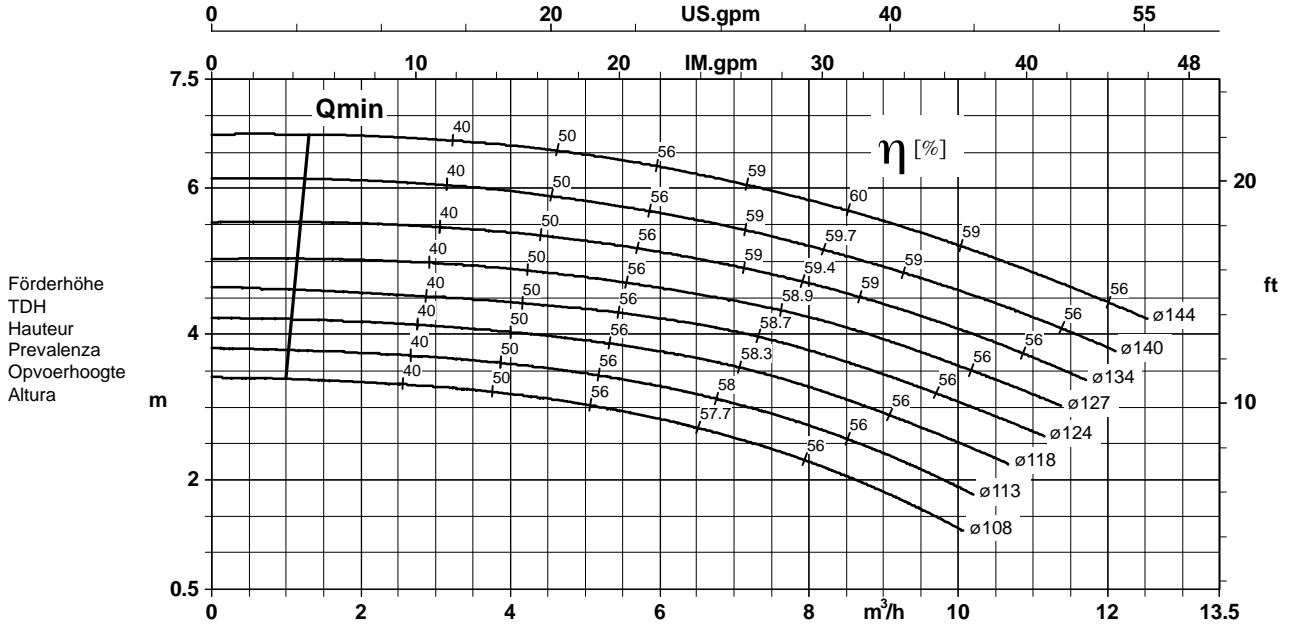

Förderstrom/Flow/Débit/Portata/Kapaciteit/Caudal K1211.454/151/6

Laufradaustrittsbreite/Impeller outlet width/Largeur à la sortie de la roue 5,0 mm
 Luce della girante/Waaier uittredebreedte/Anchura de salida rodete 5,0 mm

Baureihe-Größe Type-Size Modèle	Tipo Serie Tipo	Nennzahl Nom. speed Vitesse nom.	Velocità di rotazione nom. Nominaal toerental Revoluciones nom.	Laufrad-ø Impeller Dia. Diamètre de roue	ø Girante ø Waaier ø Rodete	 KSB Aktiengesellschaft Unternehmensbereich Pumpen Industrie- und Wassertechnik Postfach 1725, 67225 Frankenthal Joh.-Klein-Str. 9, 67227 Frankenthal
Etanorm 32-160.1 Etabloc		1450 1/min				
Projekt Project Projet	Progetto Projekt Proyecto	Angebots-Nr. Project No. No. de l'offre	Offerta-No. Offertenr. Offerta-No.	Pos.-Nr. Item No. No. de pos.	Pos.-Nr. Positiennr. Pos.-Nr.	

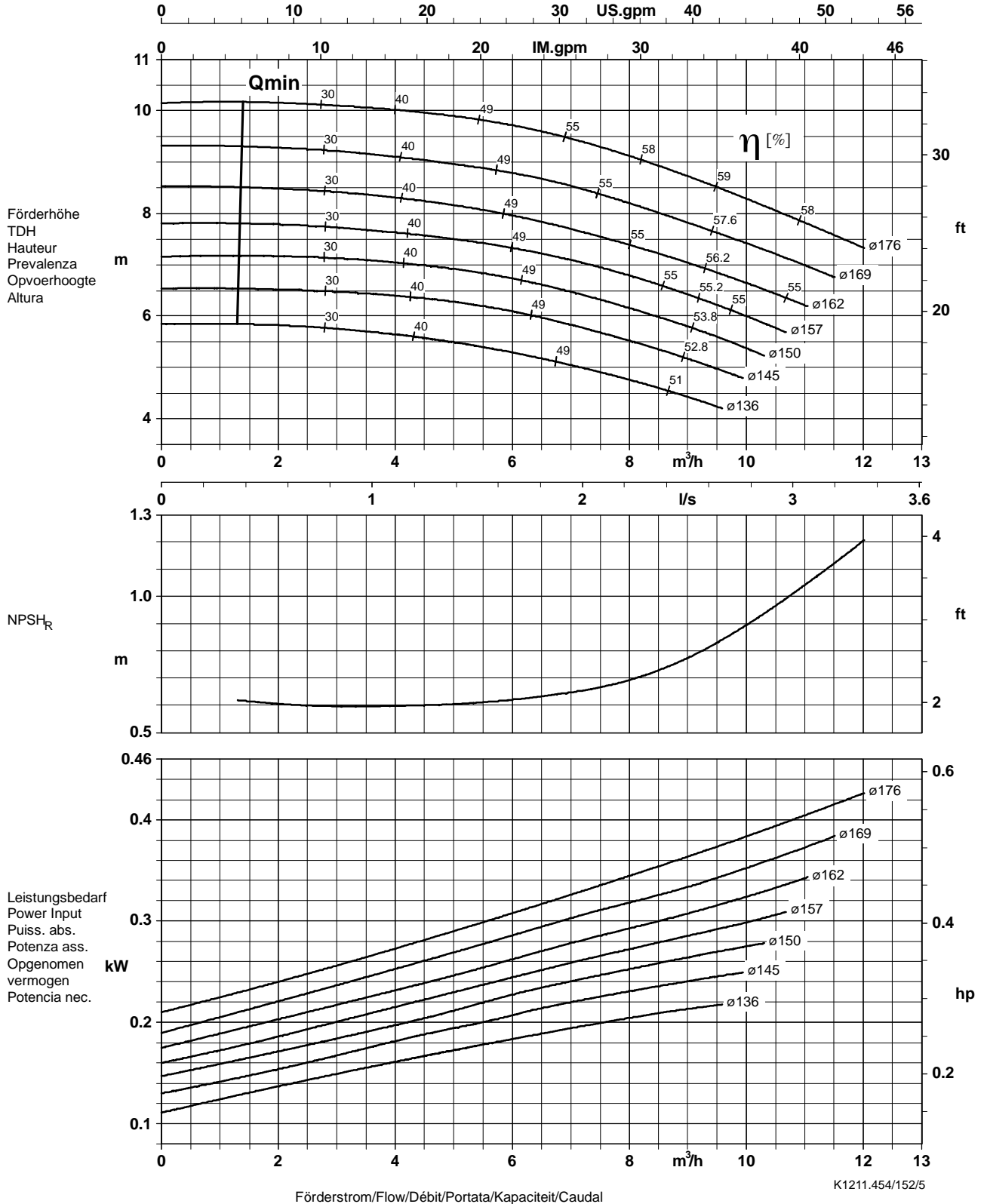

Lauftradaustrittsbreite/Impeller outlet width/Largeur à la sortie de la roue 5,6 mm
 Luce della girante/Waaier uitredbreedte/Anchura de salida rodete 5,6 mm

Baureihe-Größe Type-Size Modèle	Tipo Serie Tipo	Neendrehzahl Nom. speed Vitesse nom.	Velocità di rotazione nom. Nominaal toerental Revoluciones nom.	Laufrad-ø Impeller Dia. Diamètre de roue	ø Girante ø Waaier ø Rodete	 KSB Aktiengesellschaft Unternehmensbereich Pumpen Industrie- und Wassertechnik Postfach 1725, 67225 Frankenthal Joh.-Klein-Str. 9, 67227 Frankenthal
Etanorm 32-200.1 Etabloc		1450 1/min				
Projekt Project Projet	Progetto Projekt Proyecto	Angebots-Nr. Project No. No. de l'offre	Offerta-No. Offertenr. Offerta-No.	Pos.-Nr. Item No. No. de pos.	Pos.-Nr. Positiën. Pos.-Nr.	

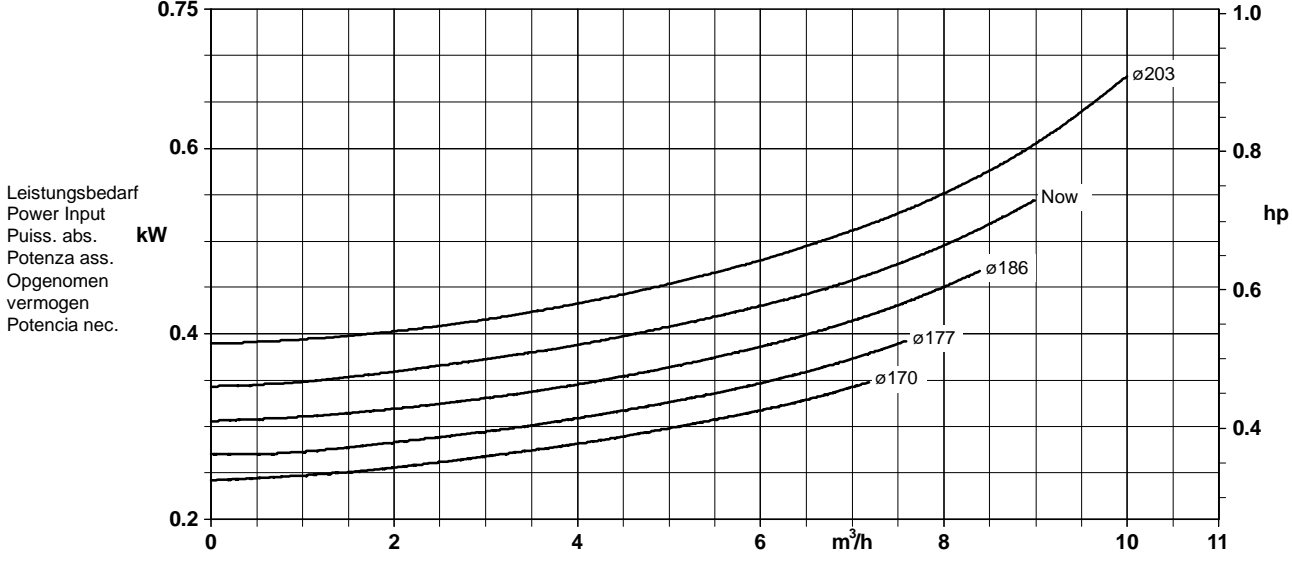
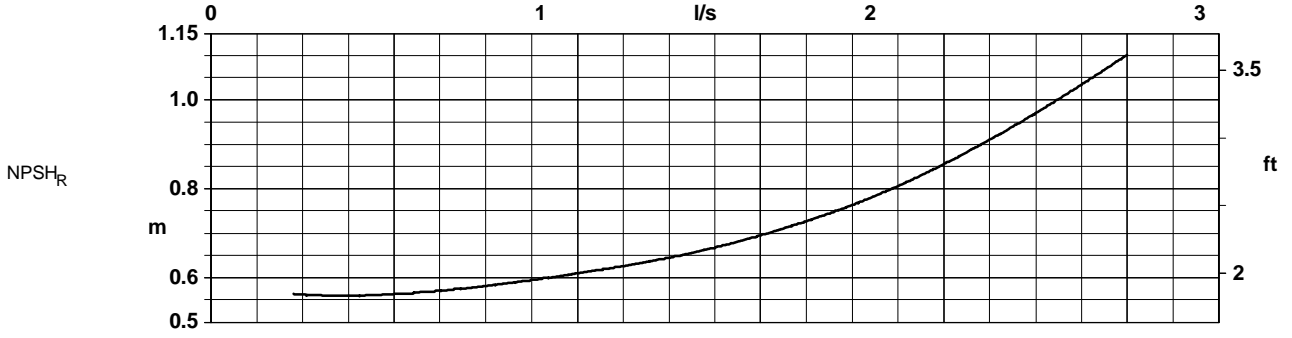
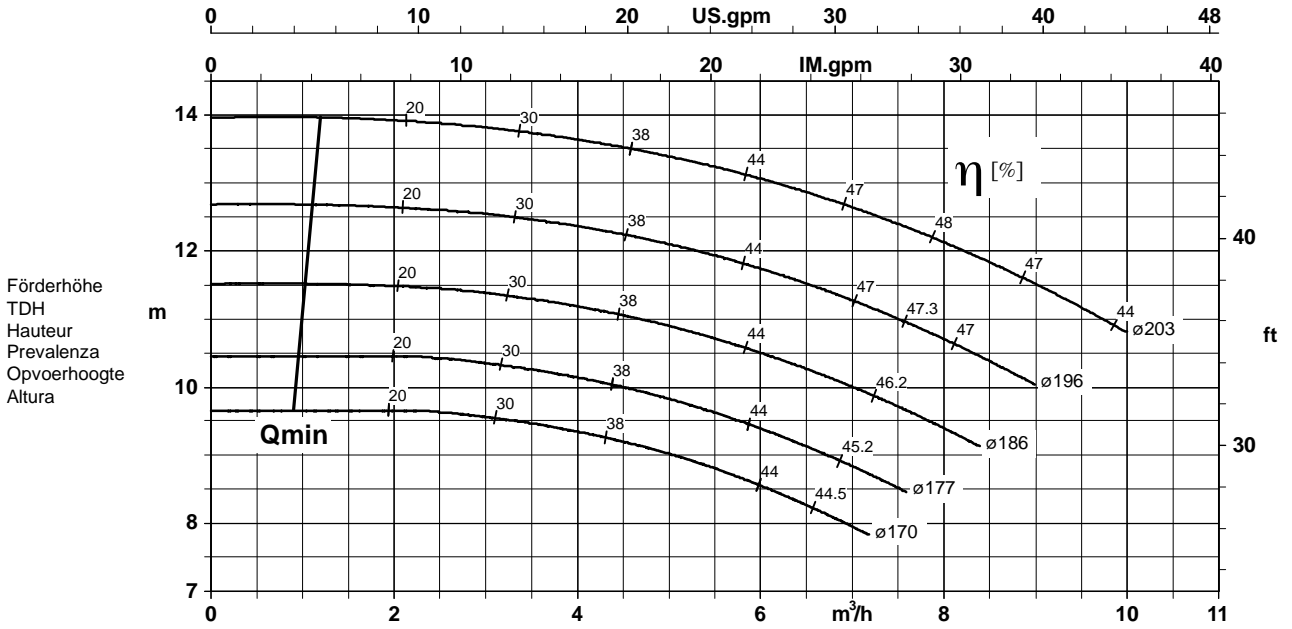

Förderstrom/Flow/Débit/Portata/Kapazität/Caudal

K1211.454/142/5

Laufradaustrittsbreite/Impeller outlet width/Largeur à la sortie de la roue 6,0 mm
 Luce della girante/Waaier uittredebreedte/Anchura de salida rodete 6,0 mm

Baureihe-Größe Type-Size Modèle	Tipo Serie Tipo	Nenn Drehzahl Nom. speed Vitesse nom.	Velocità di rotazione nom. Nominaal toerental Revoluciones nom.	Lauf rad-ø Impeller Dia. Diamètre de roue	ø Girante ø Waaier ø Rodete	 KSB Aktiengesellschaft Unternehmensbereich Pumpen Industrie- und Wassertechnik Postfach 1725, 67225 Frankenthal Joh.-Klein-Str. 9, 67227 Frankenthal
Etanorm 32-250.1 Etabloc		1450 1/min				
Projekt Project Projet	Progetto Projekt Proyecto	Angebots-Nr. Project No. No. de l'offre	Offerta-No. Offertenr. Offerta-No.	Pos.-Nr. Item No. No. de pos.	Pos.-Nr. Positiën. Pos.-Nr.	

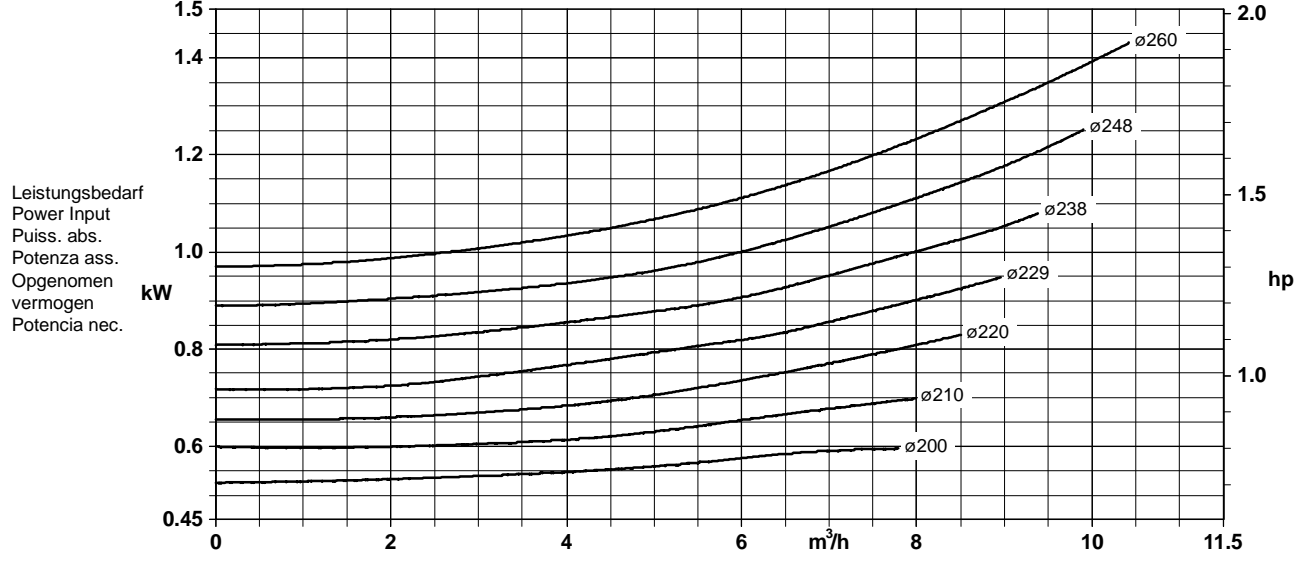
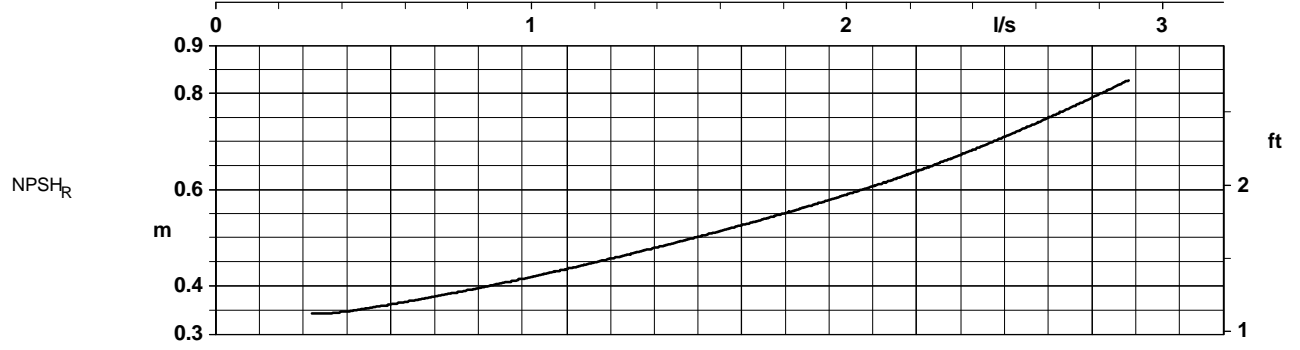
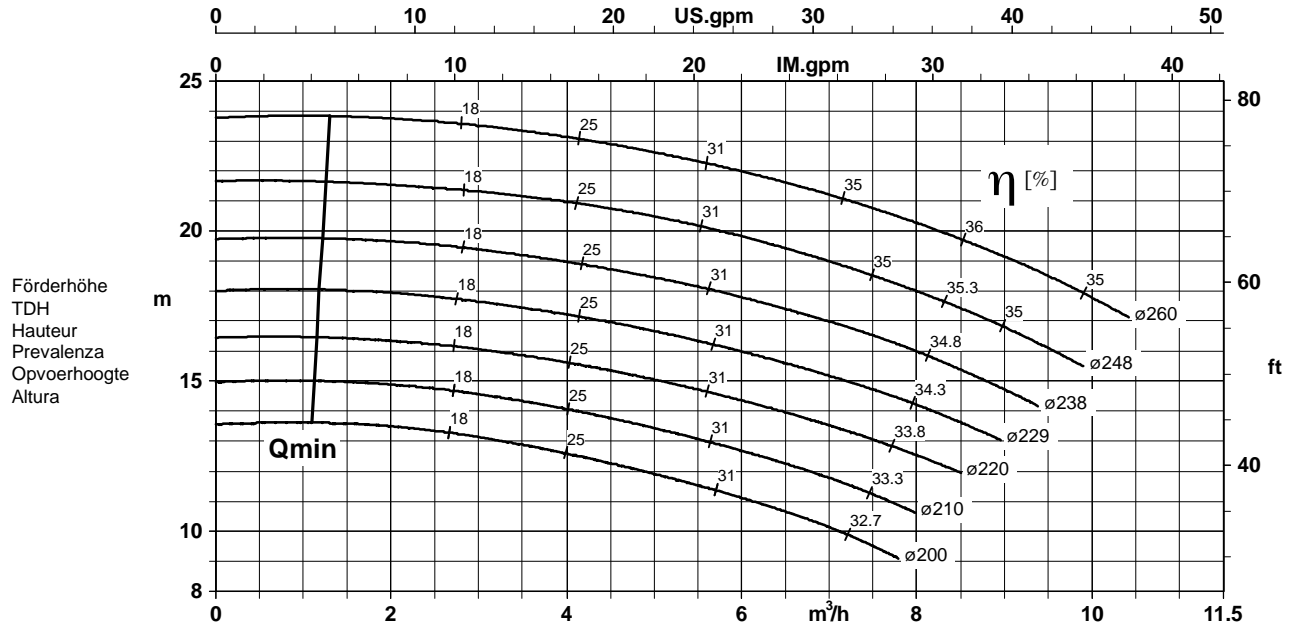

Förderstrom/Flow/Débit/Portata/Kapazität/Caudal K1211.454/143/5

Lauf rad austrittsbreite/Impeller outlet width/Largeur à la sortie de la roue 8,0 mm
 Luce della girante/Waaier uitredbreedte/Anchura de salida rodete 8,0 mm

Baureihe-Größe Type-Size Modèle	Tipo Serie Tipo	Nenn Drehzahl Nom. speed Vitesse nom.	Velocità di rotazione nom. Nominaal toerental Revoluciones nom.	Lauf rad- \varnothing Impeller Dia. Diamètre de roue	\varnothing Girante \varnothing Waaier \varnothing Rodete	 KSB Aktiengesellschaft Unternehmensbereich Pumpen Industrie- und Wassertechnik Postfach 1725, 67225 Frankenthal Joh.-Klein-Str. 9, 67227 Frankenthal
Etanorm 32-125 Etabloc		1450 1/min				
Projekt Project Projet	Progetto Projekt Proyecto	Angebots-Nr. Project No. No. de l'offre	Offerta-No. Offertenr. Offerta-No.	Pos.-Nr. Item No. No. de pos.	Pos.-Nr. Positiernr. Pos.-Nr.	

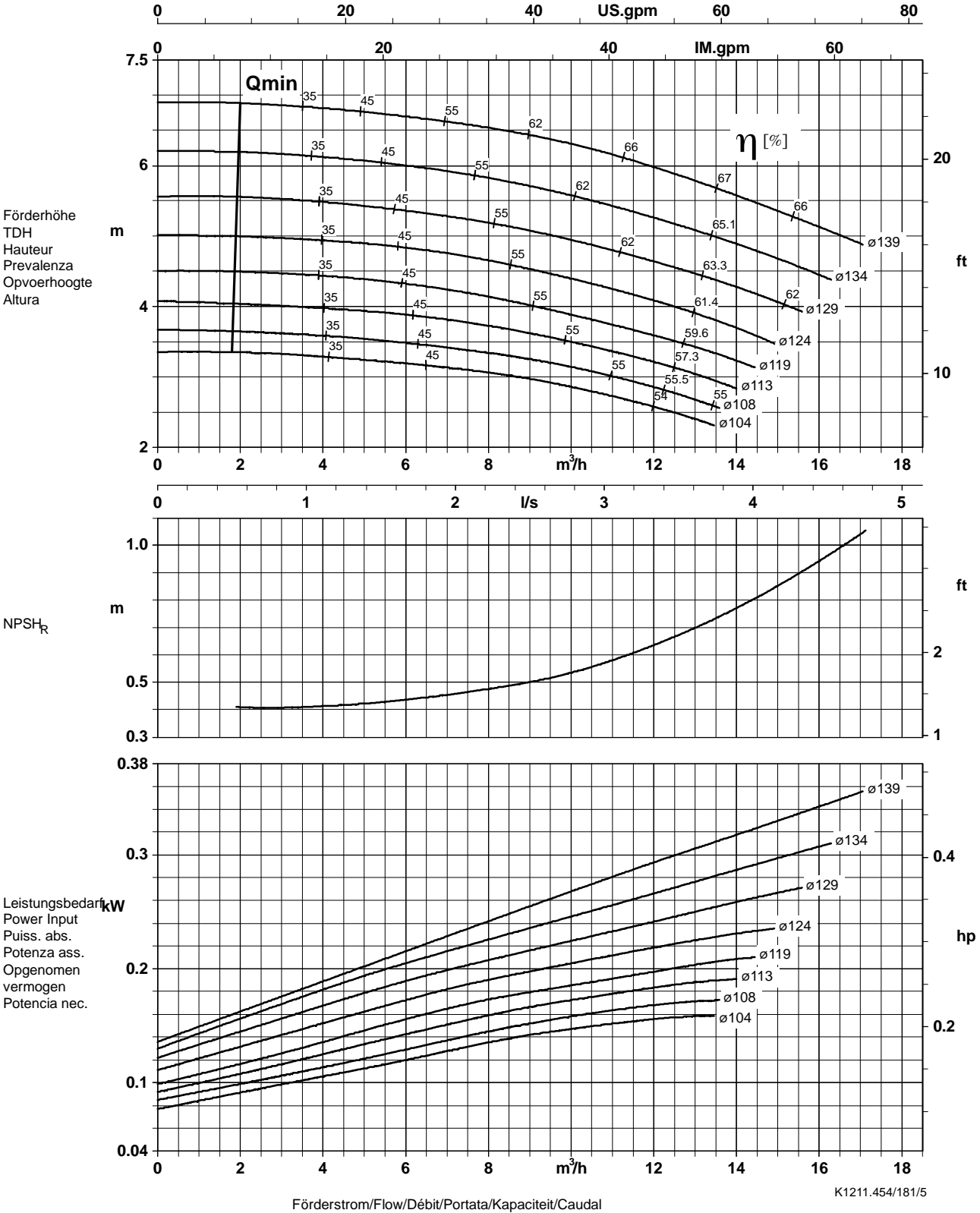

Lauf rad austrittsbreite / Impeller outlet width / Largeur à la sortie de la roue 9,6 mm
 Luce della girante / Waaier uittredbreedte / Anchura de salida rodete 9,6 mm

Baureihe-Größe Type-Size Modèle	Tipo Serie Tipo	Nennzahl Nom. speed Vitesse nom.	Velocità di rotazione nom. Nominaal toerental Revoluciones nom.	Lauf-rad-ø Impeller Dia. Diamètre de roue	ø Girante ø Waaier ø Rodete	 KSB Aktiengesellschaft Unternehmensbereich Pumpen Industrie- und Wassertechnik Postfach 1725, 67225 Frankenthal Joh.-Klein-Str. 9, 67227 Frankenthal
Etanorm 32-160 Etabloc		1450 1/min				
Projekt Project Projet	Progetto Projekt Proyecto	Angebots-Nr. Project No. No. de l'offre	Offerta-No. Offertenr. Offerta-No.	Pos.-Nr. Item No. No. de pos.	Pos.-Nr. Positiönr. Pos.-Nr.	

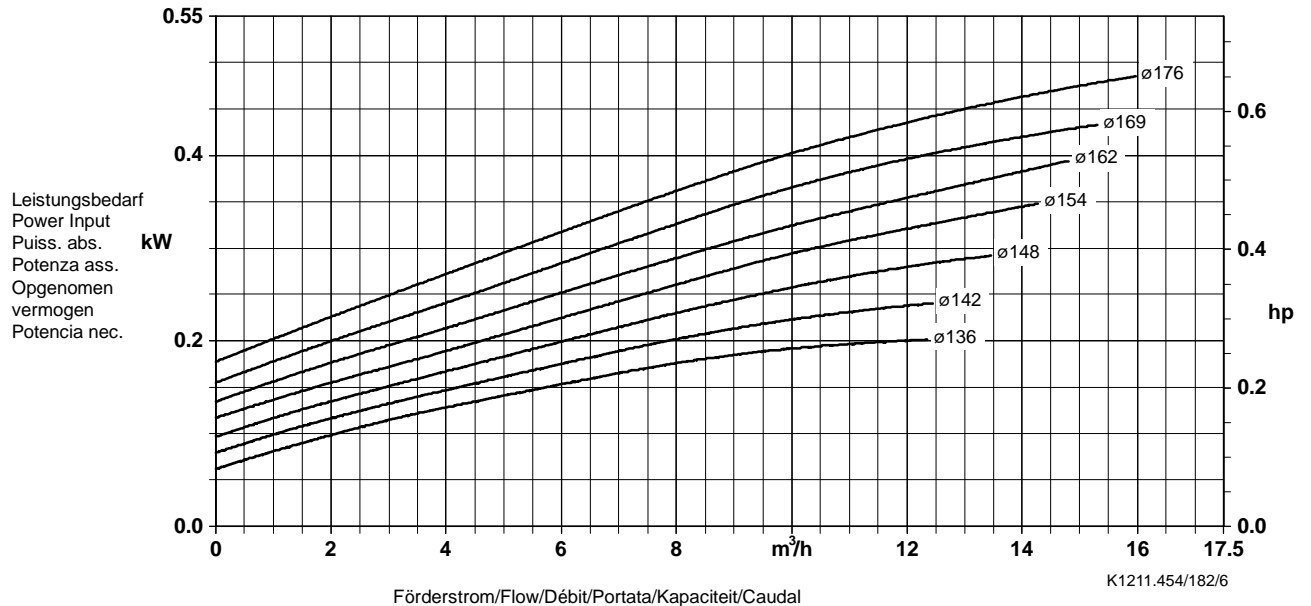
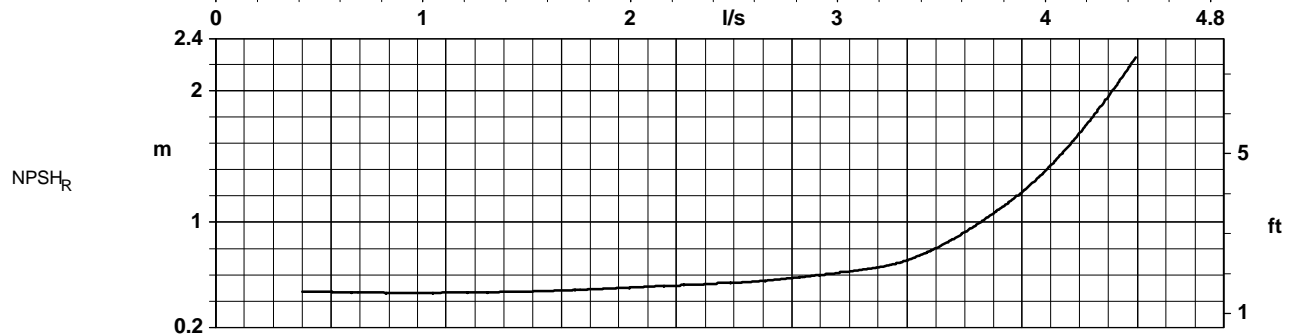
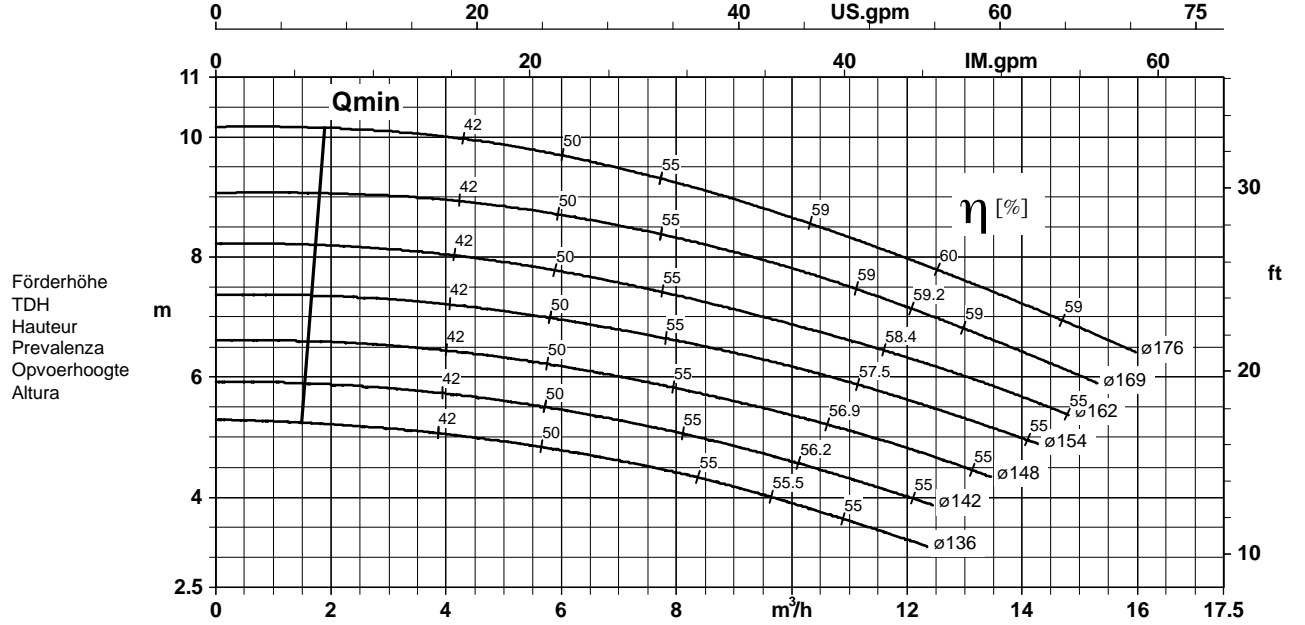

Laufradaustrittsbreite/Impeller outlet width/Largeur à la sortie de la roue 5,6 mm
 Luce della girante/Waaier uitredbreedte/Anchura de salida rodete 5,6 mm

Baureihe-Größe Type-Size Modèle	Tipo Serie Tipo	Neendrehzahl Nom. speed Vitesse nom.	Velocità di rotazione nom. Nominaal toerental Revoluciones nom.	Laufrad-ø Impeller Dia. Diamètre de roue	ø Girante ø Waaier ø Rodete	 KSB Aktiengesellschaft Unternehmensbereich Pumpen Industrie- und Wassertechnik Postfach 1725, 67225 Frankenthal Joh.-Klein-Str. 9, 67227 Frankenthal
Etanorm 32-200 Etabloc		1450 1/min				
Projekt Project Projet	Progetto Projekt Proyecto	Angebots-Nr. Project No. No. de l'offre	Offerta-No. Offertenr. Offerta-No.	Pos.-Nr. Item No. No. de pos.	Pos.-Nr. Positiën. Pos.-Nr.	

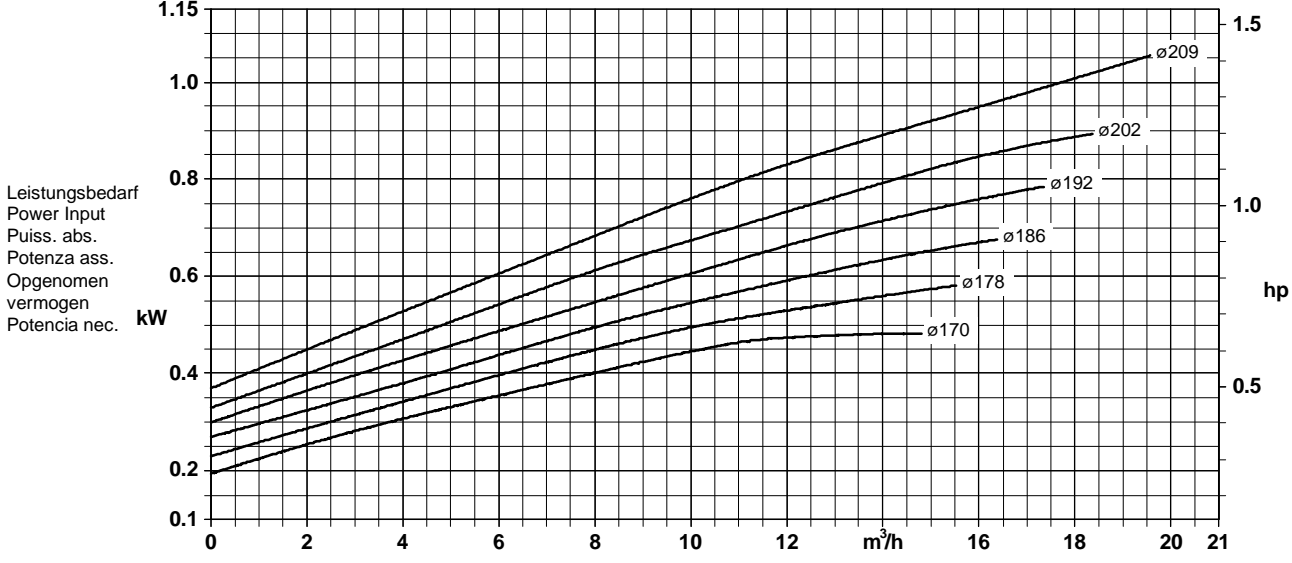
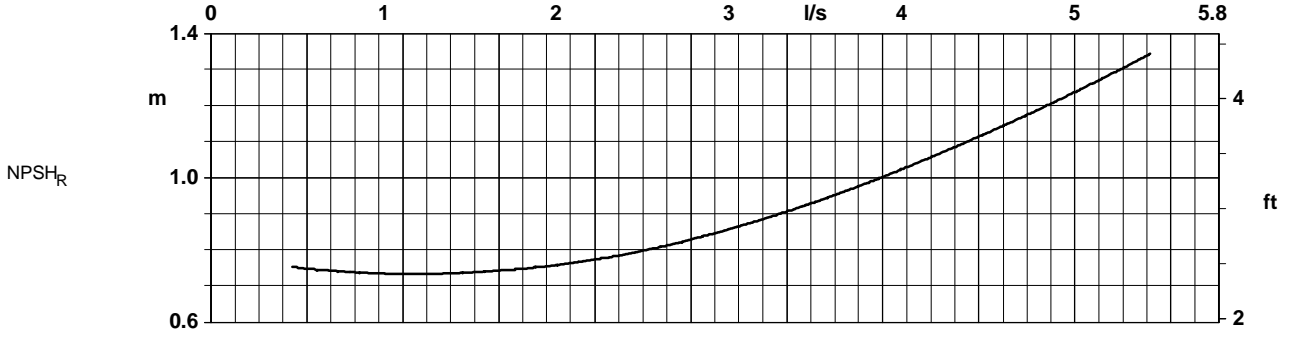
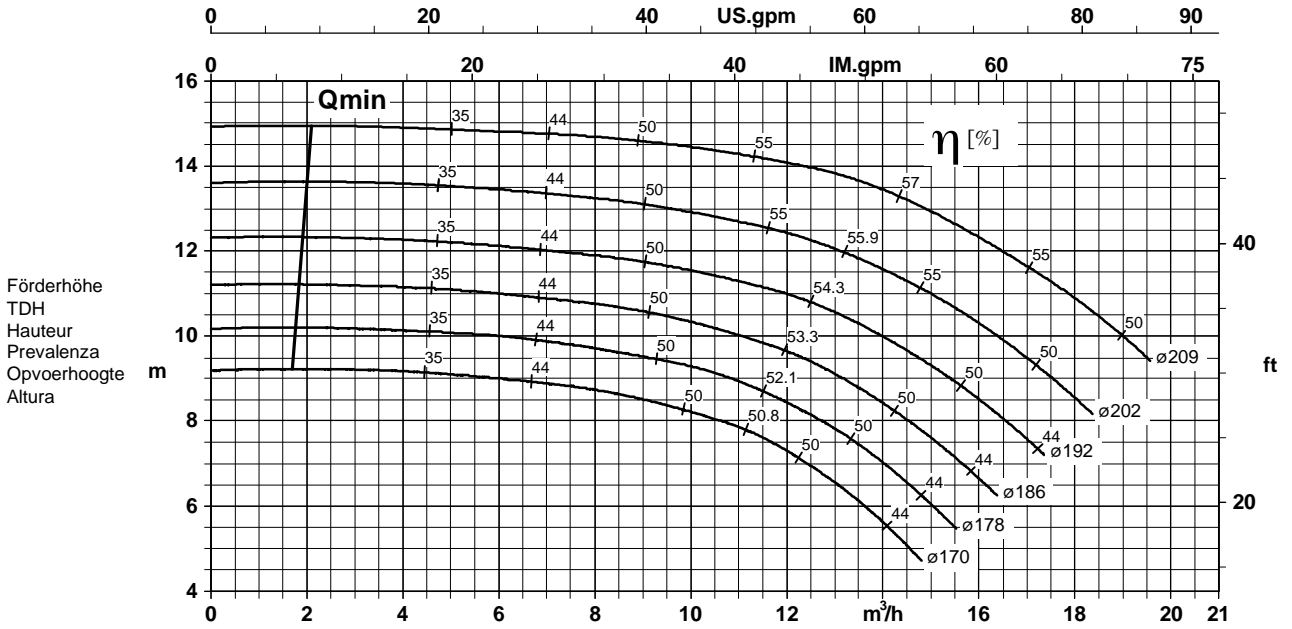

Förderstrom/Flow/Débit/Portata/Kapaciteit/Caudal K1211.454/183/5

Laufradaustrittsbreite/Impeller outlet width/Largeur à la sortie de la roue 6,0 mm
 Luce della girante/Waaier uittredebreedte/Anchura de salida rodete 6,0 mm

Baureihe-Größe Type-Size Modèle	Tipo Serie Tipo	Nenndrehzahl Nom. speed Vitesse nom.	Velocità di rotazione nom. Nominaal toerental Revoluciones nom.	Laufrad-ø Impeller Dia. Diamètre de roue	ø Girante ø Waaier ø Rodete	 KSB Aktiengesellschaft Unternehmensbereich Pumpen Industrie- und Wassertechnik Postfach 1725, 67225 Frankenthal Joh.-Klein-Str. 9, 67227 Frankenthal
Etanorm 32-250 Etabloc		1450 1/min				
Projekt Project Projet	Progetto Projekt Proyecto	Angebots-Nr. Project No. No. de l'offre	Offerta-No. Offertenr. Offerta-No.	Pos.-Nr. Item No. No. de pos.	Pos.-Nr. Positiernr. Pos.-Nr.	

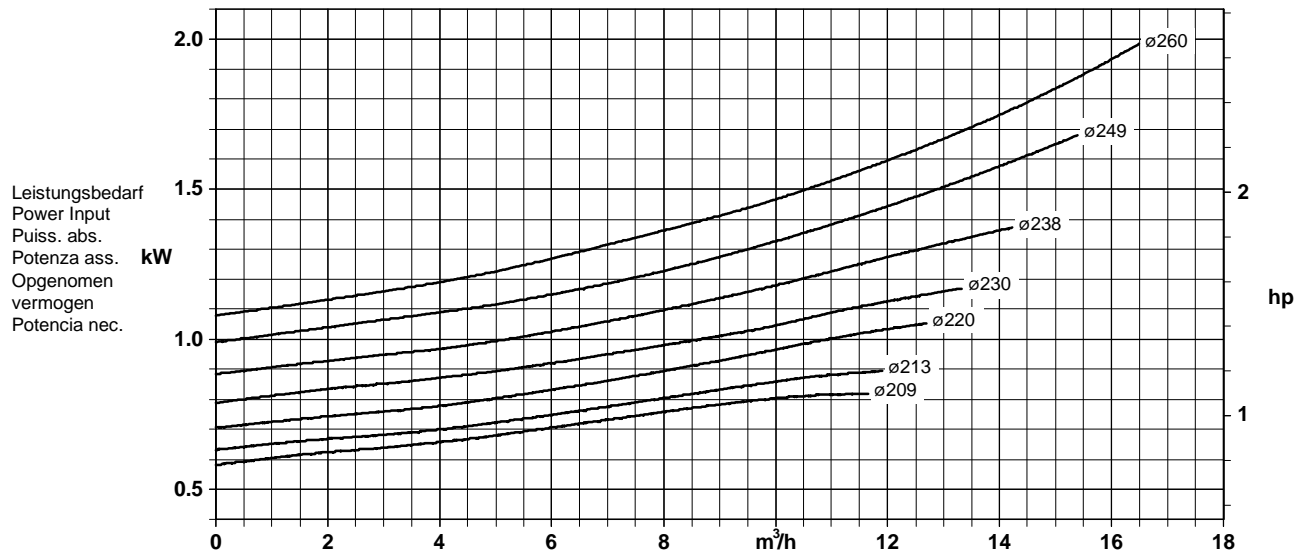
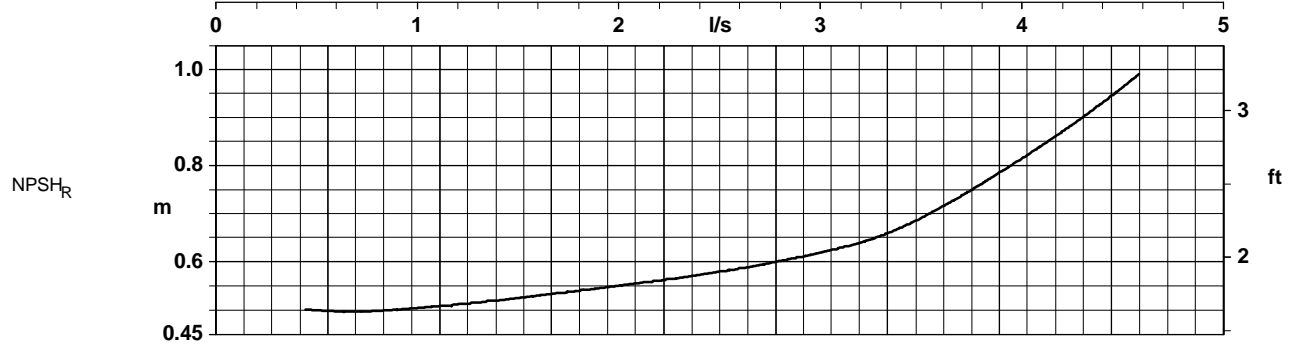
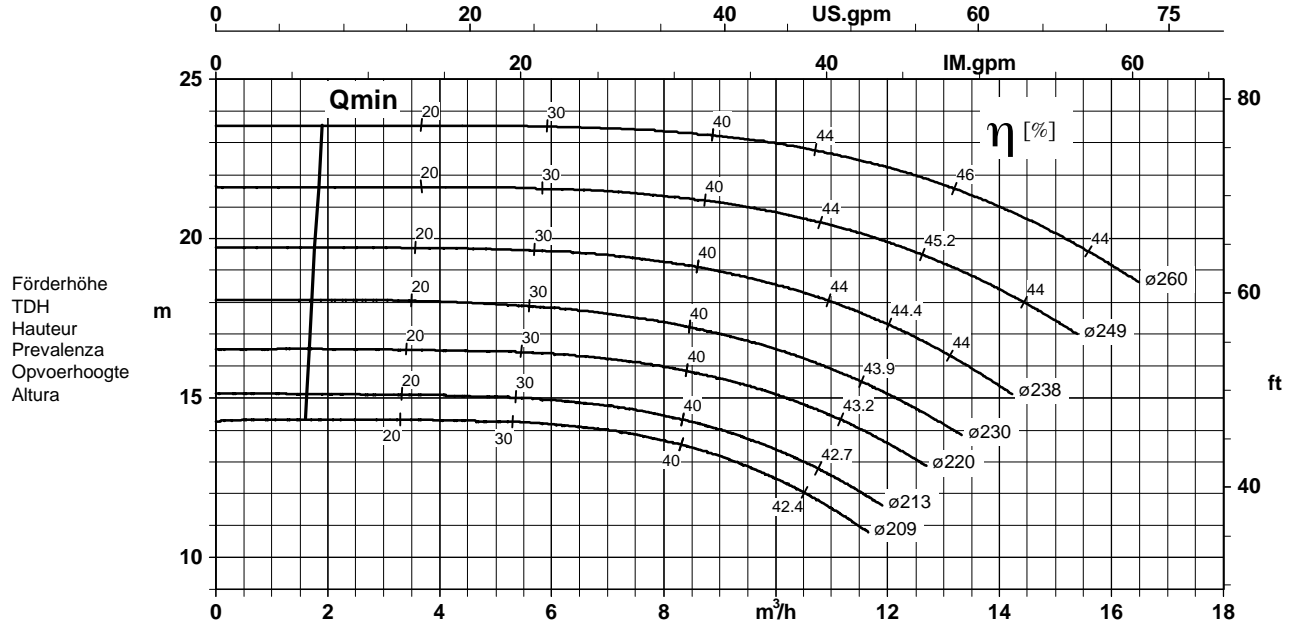

Förderstrom/Flow/Débit/Portata/Kapazität/Caudal

K1211.454/184/5

Laufradaustrittsbreite/Impeller outlet width/Largeur à la sortie de la roue 8,0 mm
 Luce della girante/Waaier uitredbreedte/Anchura de salida rodete 8,0 mm

Baureihe-Größe Type-Size Modèle	Tipo Serie Tipo	Neendrehzahl Nom. speed Vitesse nom.	Velocità di rotazione nom. Nominaal toerental Revoluciones nom.	Lauftrad-ø Impeller Dia. Diamètre de roue	ø Girante ø Waaier ø Rodete	 KSB Aktiengesellschaft Unternehmensbereich Pumpen Industrie- und Wassertechnik Postfach 1725, 67225 Frankenthal Joh.-Klein-Str. 9, 67227 Frankenthal
Etanorm 40-125 Etabloc		1450 1/min				
Projekt Project Projet	Progetto Projekt Proyecto	Angebots-Nr. Project No. No. de l'offre	Offerta-No. Offertenr. Offerta-No.	Pos.-Nr. Item No. No. de pos.	Pos.-Nr. Positiën. Pos.-Nr.	

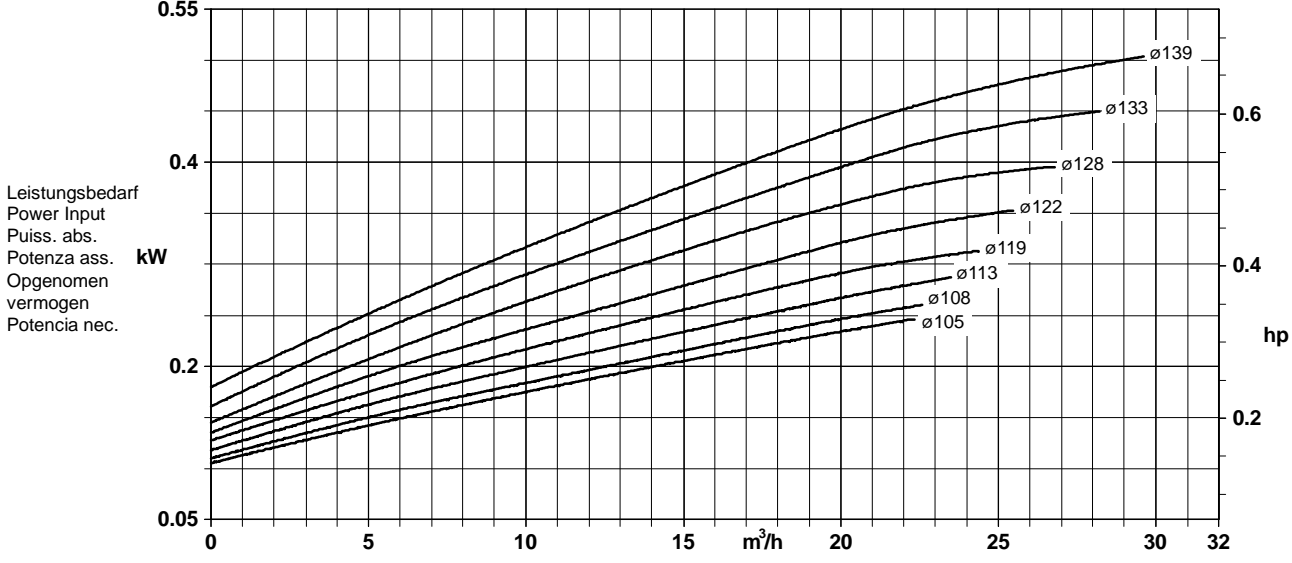
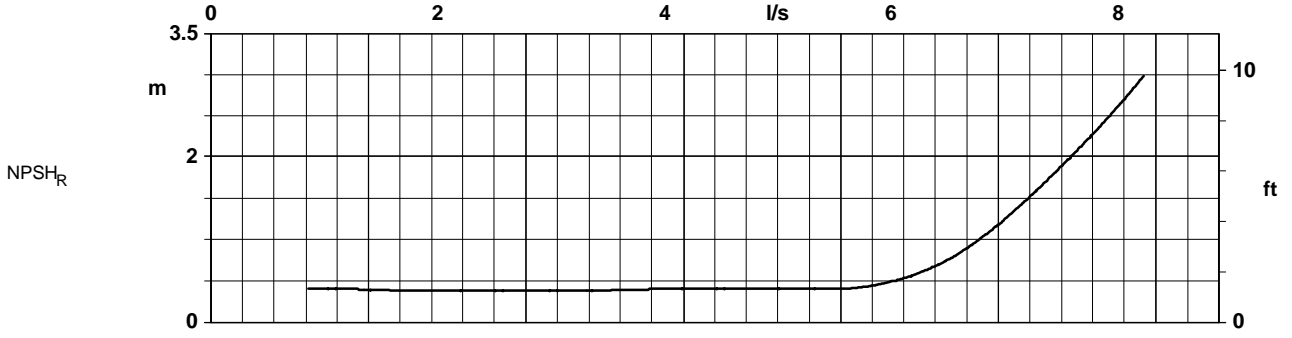
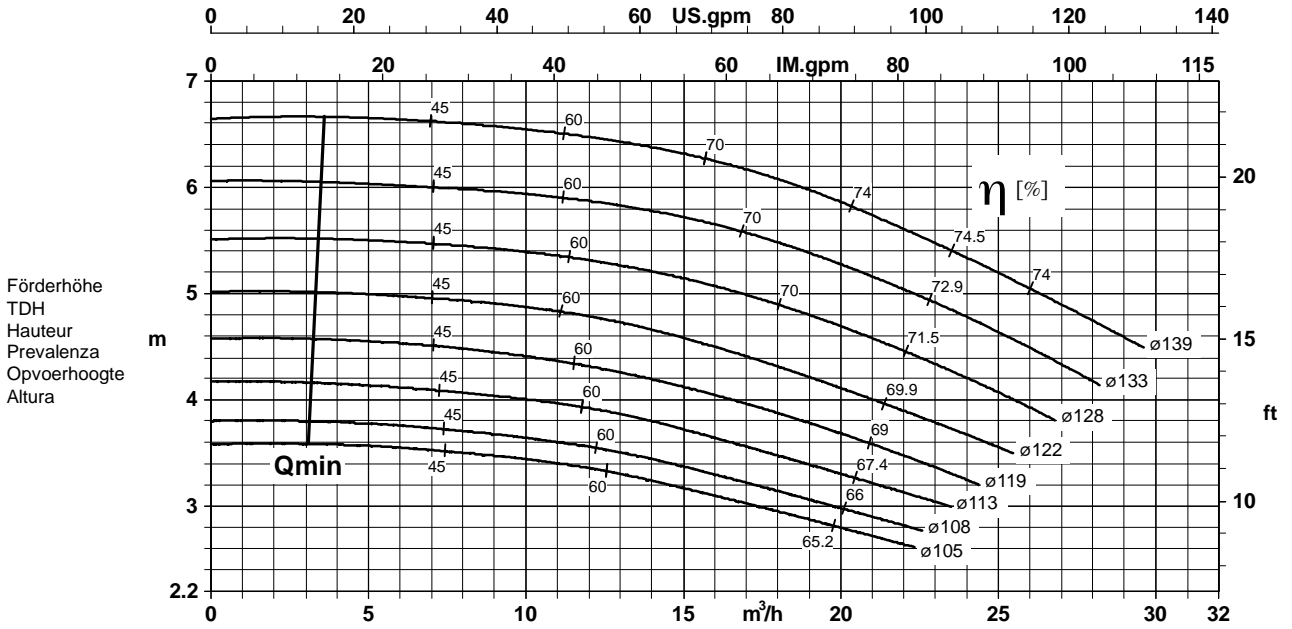

Förderstrom/Flow/Débit/Portata/Kapazität/Caudal K1211.454/231/5

Laufradaustrittsbreite/Impeller outlet width/Largeur à la sortie de la roue 14,0 mm
 Luce della girante/Waaier uittredebreedte/Anchura de salida rodete 14,0 mm

Baureihe-Größe Type-Size Modèle	Tipo Serie Tipo	Nennzahl Nom. speed Vitesse nom.	Velocità di rotazione nom. Nominaal toerental Revoluciones nom.	Lauf-rad-ø Impeller Dia. Diamètre de roue	ø Girante ø Waaier ø Rodete	 KSB Aktiengesellschaft Unternehmensbereich Pumpen Industrie- und Wassertechnik Postfach 1725, 67225 Frankenthal Joh.-Klein-Str. 9, 67227 Frankenthal
Etanorm 40-160 Etabloc		1450 1/min				
Projekt Project Projet	Progetto Projekt Proyecto	Angebots-Nr. Project No. No. de l'offre	Offerta-No. Offertenr. Offerta-No.	Pos.-Nr. Item No. No. de pos.	Pos.-Nr. Positiennr. Pos.-Nr.	

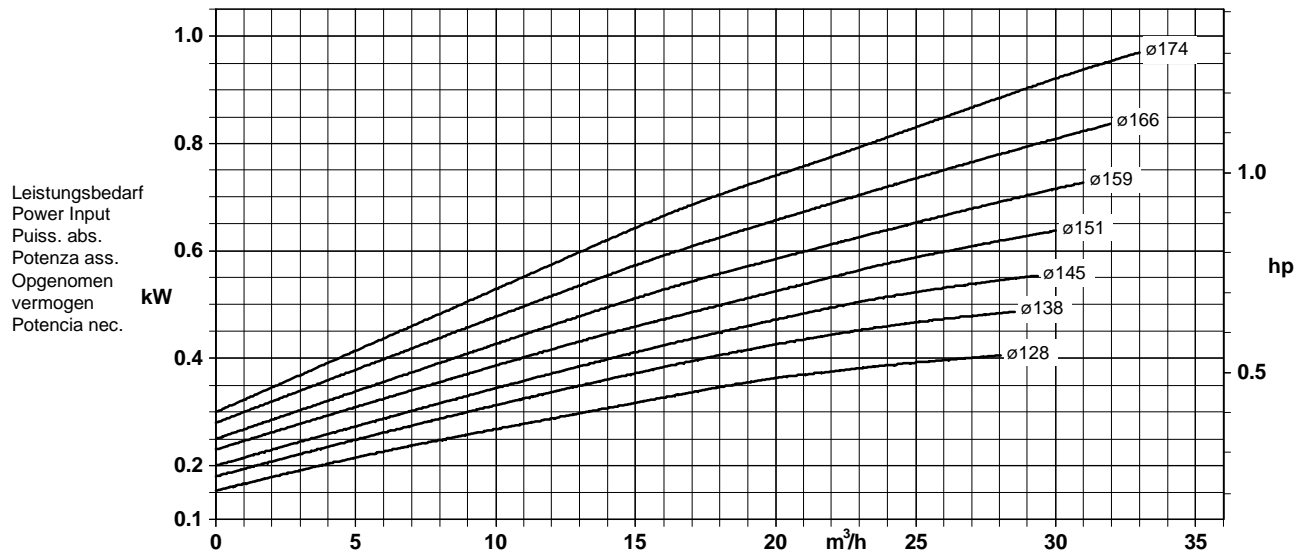
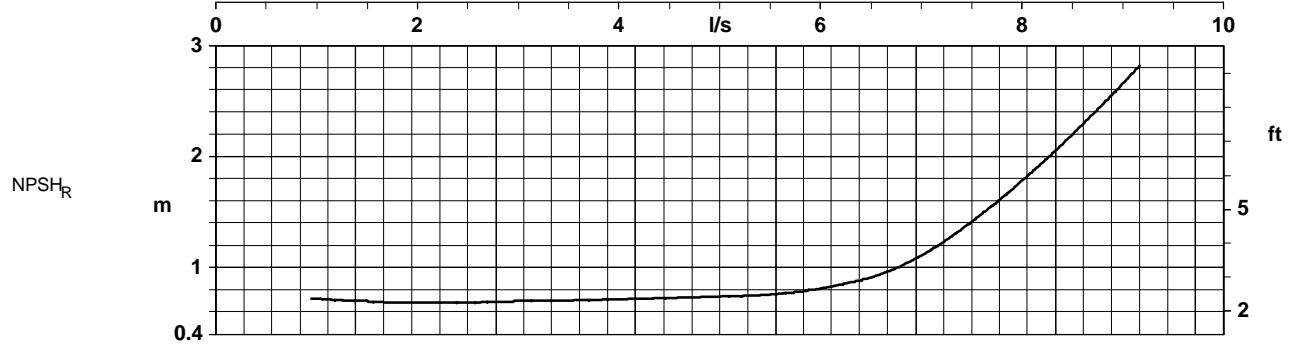
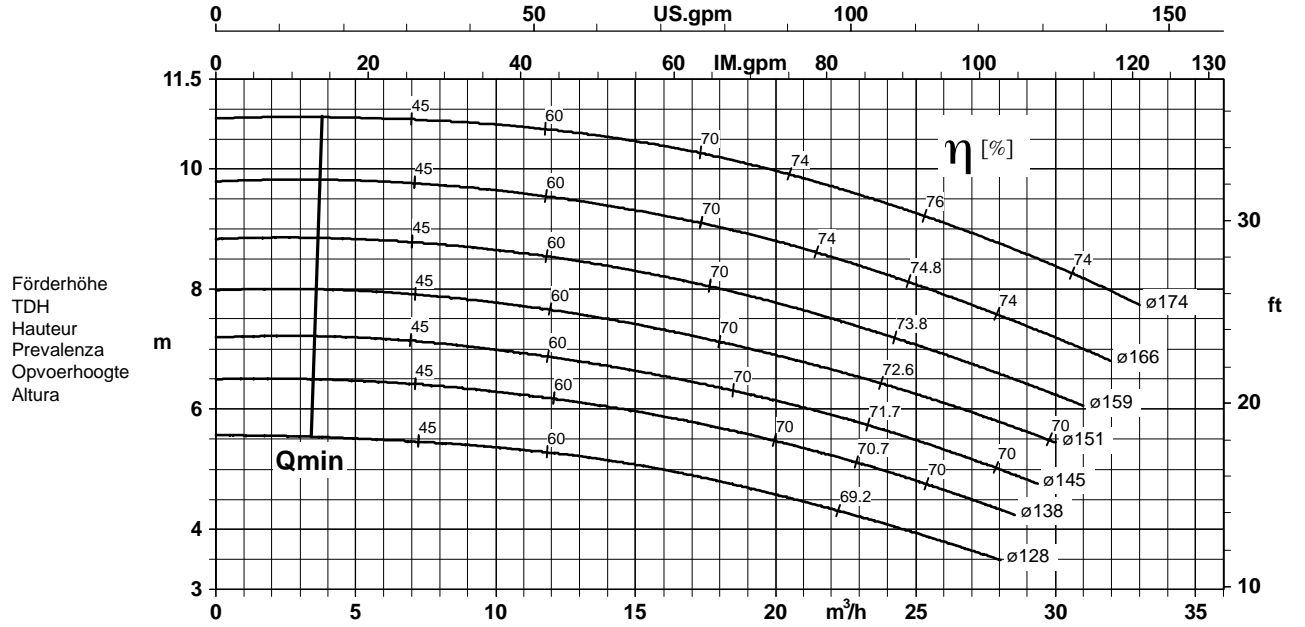

Förderstrom/Flow/Débit/Portata/Kapazität/Caudal

K1211.454/242/5

Lauftradaustrittsbreite/Impeller outlet width/Largeur à la sortie de la roue 12,0 mm
 Luce della girante/Waaier uitredbreedte/Anchura de salida rodete 12,0 mm

Baureihe-Größe Type-Size Modèle	Tipo Serie Tipo	Neendrehzahl Nom. speed Vitesse nom.	Velocità di rotazione nom. Nominaal toerental Revoluciones nom.	Laufrad-ø Impeller Dia. Diamètre de roue	ø Girante ø Waaier ø Rodete	 KSB Aktiengesellschaft Unternehmensbereich Pumpen Industrie- und Wassertechnik Postfach 1725, 67225 Frankenthal Joh.-Klein-Str. 9, 67227 Frankenthal
Etanorm 40-200 Etabloc		1450 1/min				
Projekt Project Projet	Progetto Projekt Proyecto	Angebots-Nr. Project No. No. de l'offre	Offerta-No. Offertenr. Offerta-No.	Pos.-Nr. Item No. No. de pos.	Pos.-Nr. Positiën. Pos.-Nr.	

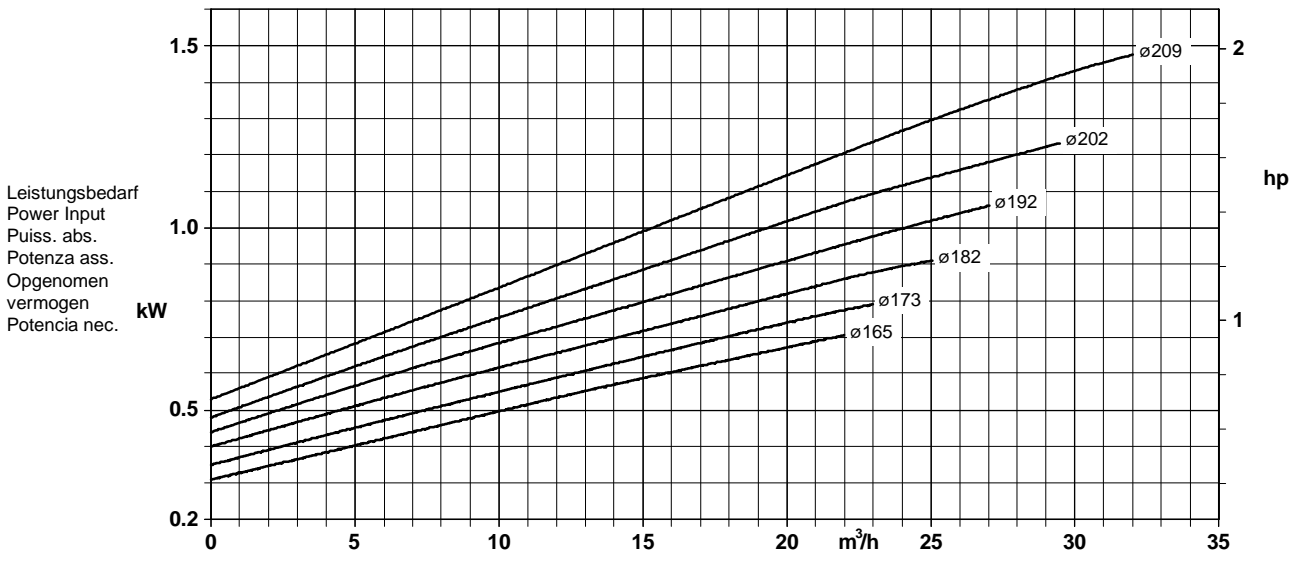
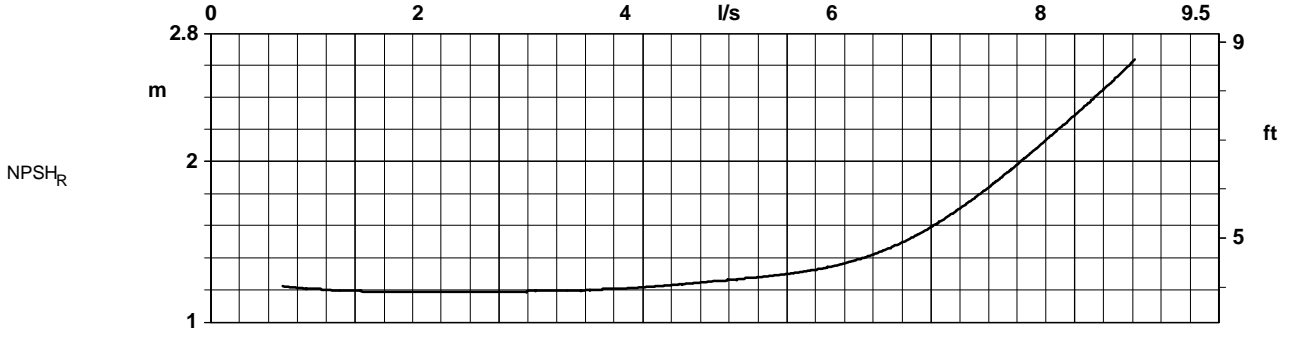
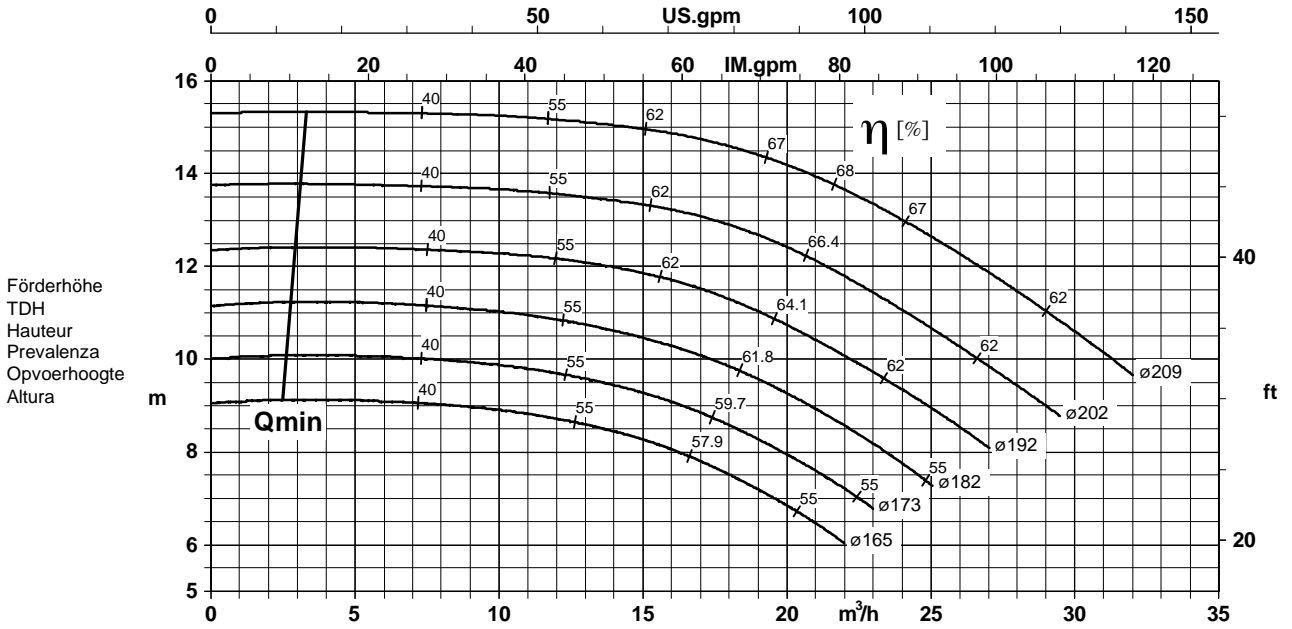

Förderstrom/Flow/Débit/Portata/Kapazität/Caudal

Laufradaustrittsbreite/Impeller outlet width/Largeur à la sortie de la roue 9,0 mm
 Luce della girante/Waaier uittredebreedte/Anchura de salida rodete 9,0 mm

K1211.454/223/5

Baureihe-Größe Type-Size Modèle	Tipo Serie Tipo	Nenndrehzahl Nom. speed Vitesse nom.	Velocità di rotazione nom. Nominaal toerental Revoluciones nom.	Laufrad-ø Impeller Dia. Diamètre de roue	ø Girante ø Waaier ø Rodete	 KSB Aktiengesellschaft Unternehmensbereich Pumpen Industrie- und Wassertechnik Postfach 1725, 67225 Frankenthal Joh.-Klein-Str. 9, 67227 Frankenthal
Etanorm 40-250 Etabloc		1450 1/min				
Projekt Project Projet	Progetto Projekt Proyecto	Angebots-Nr. Project No. No. de l'offre	Offerta-No. Offertenr. Offerta-No.	Pos.-Nr. Item No. No. de pos.	Pos.-Nr. Positiën. Pos.-Nr.	

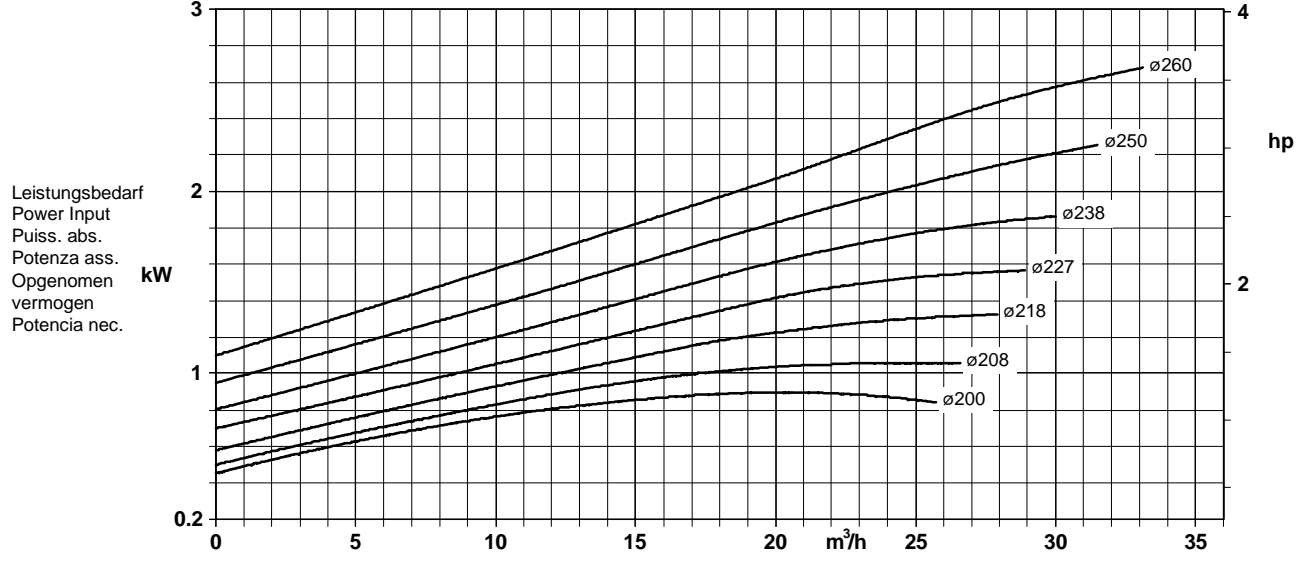
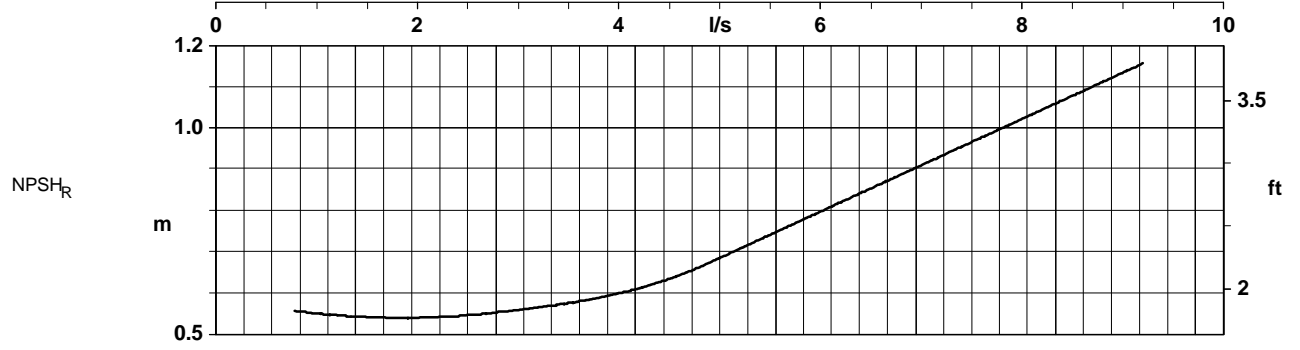
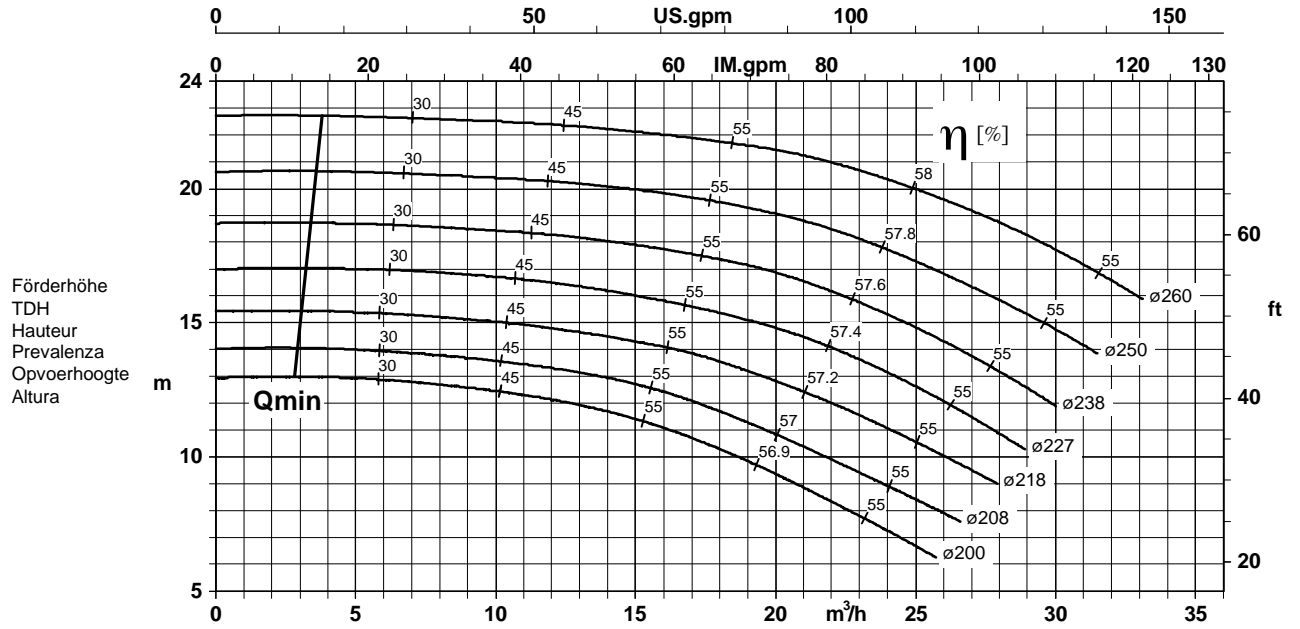

Förderstrom/Flow/Débit/Portata/Kapazität/Caudal

K1211.454/244/5

Laufradaustrittsbreite/Impeller outlet width/Largeur à la sortie de la roue 8,0 mm
 Luce della girante/Waaier uitredbreedte/Anchura de salida rodete 8,0 mm

Baureihe-Größe Type-Size Modèle	Tipo Serie Tipo	Neendrehzahl Nom. speed Vitesse nom.	Velocità di rotazione nom. Nominaal toerental Revoluciones nom.	Laufrad-ø Impeller Dia. Diamètre de roue	ø Girante ø Waaier ø Rodete	 KSB Aktiengesellschaft Unternehmensbereich Pumpen Industrie- und Wassertechnik Postfach 1725, 67225 Frankenthal Joh.-Klein-Str. 9, 67227 Frankenthal
Etanorm 40-315 Etabloc		1450 1/min				
Projekt Project Projet	Progetto Projekt Proyecto	Angebots-Nr. Project No. No. de l'offre	Offerta-No. Offertenr. Offerta-No.	Pos.-Nr. Item No. No. de pos.	Pos.-Nr. Positiernr. Pos.-Nr.	

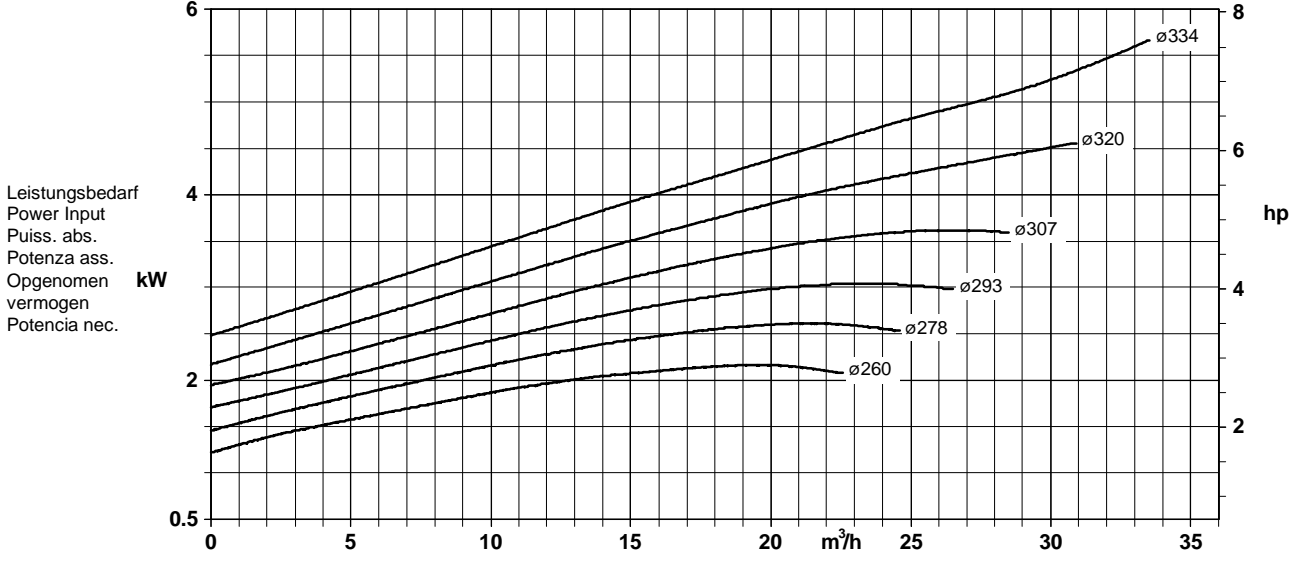
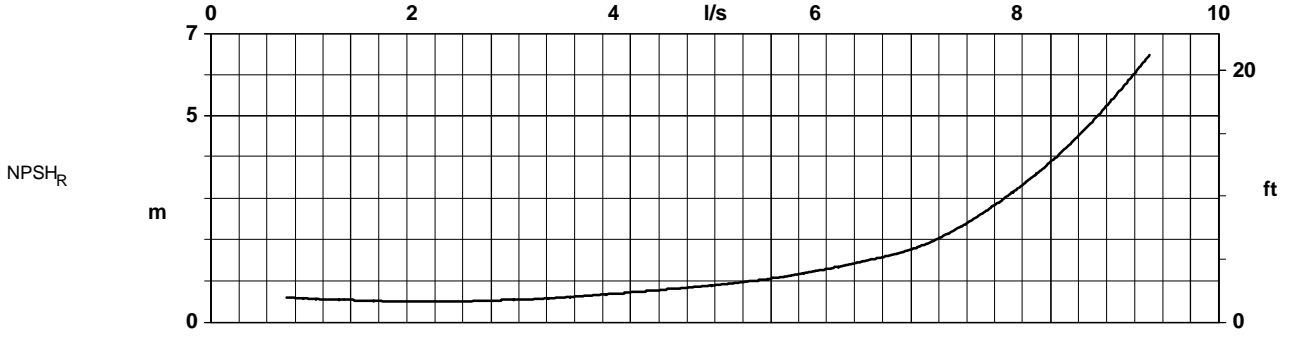
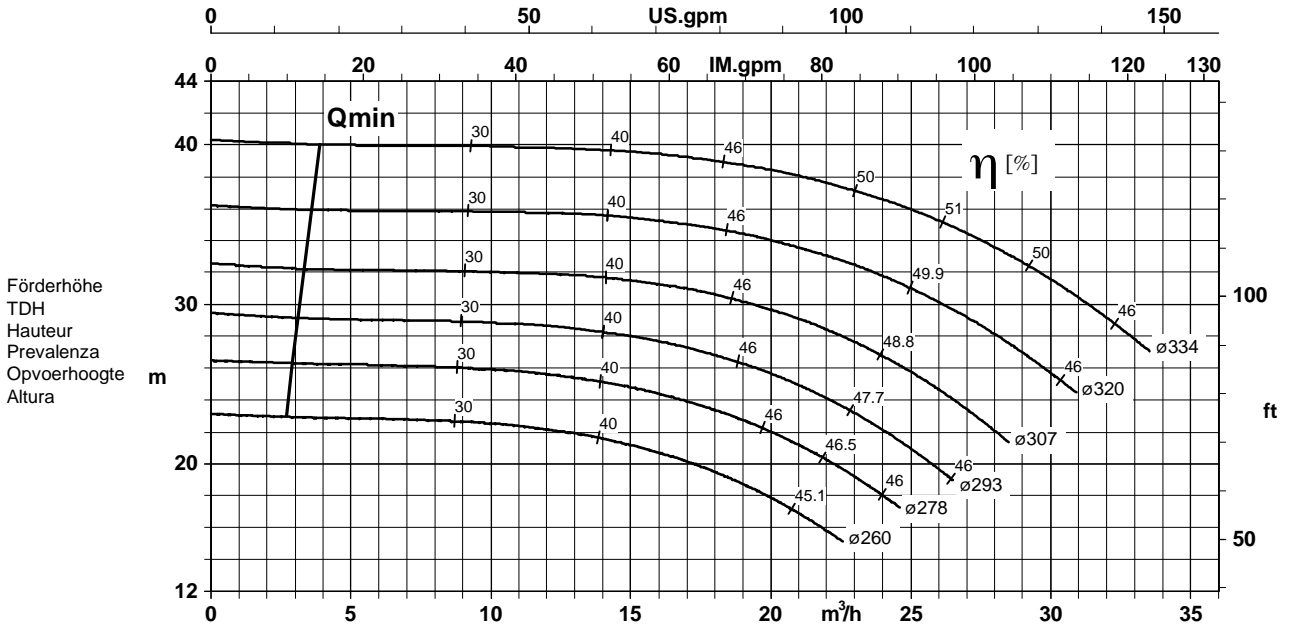

Förderstrom/Flow/Débit/Portata/Kapazität/Caudal

Laufradaustrittsbreite/Impeller outlet width/Largeur à la sortie de la roue 9,0 mm
 Luce della girante/Waaier uittredbreedte/Anchura de salida rodete 9,0 mm

K1211.454/245/4

Baureihe-Größe Type-Size Modèle	Tipo Serie Tipo	Neendrehzahl Nom. speed Vitesse nom.	Velocità di rotazione nom. Nominaal toerental Revoluciones nom.	Laufrad-ø Impeller Dia. Diamètre de roue	ø Girante ø Waaier ø Rodete	 KSB Aktiengesellschaft Unternehmensbereich Pumpen Industrie- und Wassertechnik Postfach 1725, 67225 Frankenthal Joh.-Klein-Str. 9, 67227 Frankenthal
Etanorm 50-125 Etabloc		1450 1/min				
Projekt Project Projet	Progetto Projekt Proyecto	Angebots-Nr. Project No. No. de l'offre	Offerta-No. Offertenr. Offerta-No.	Pos.-Nr. Item No. No. de pos.	Pos.-Nr. Positiennr. Pos.-Nr.	

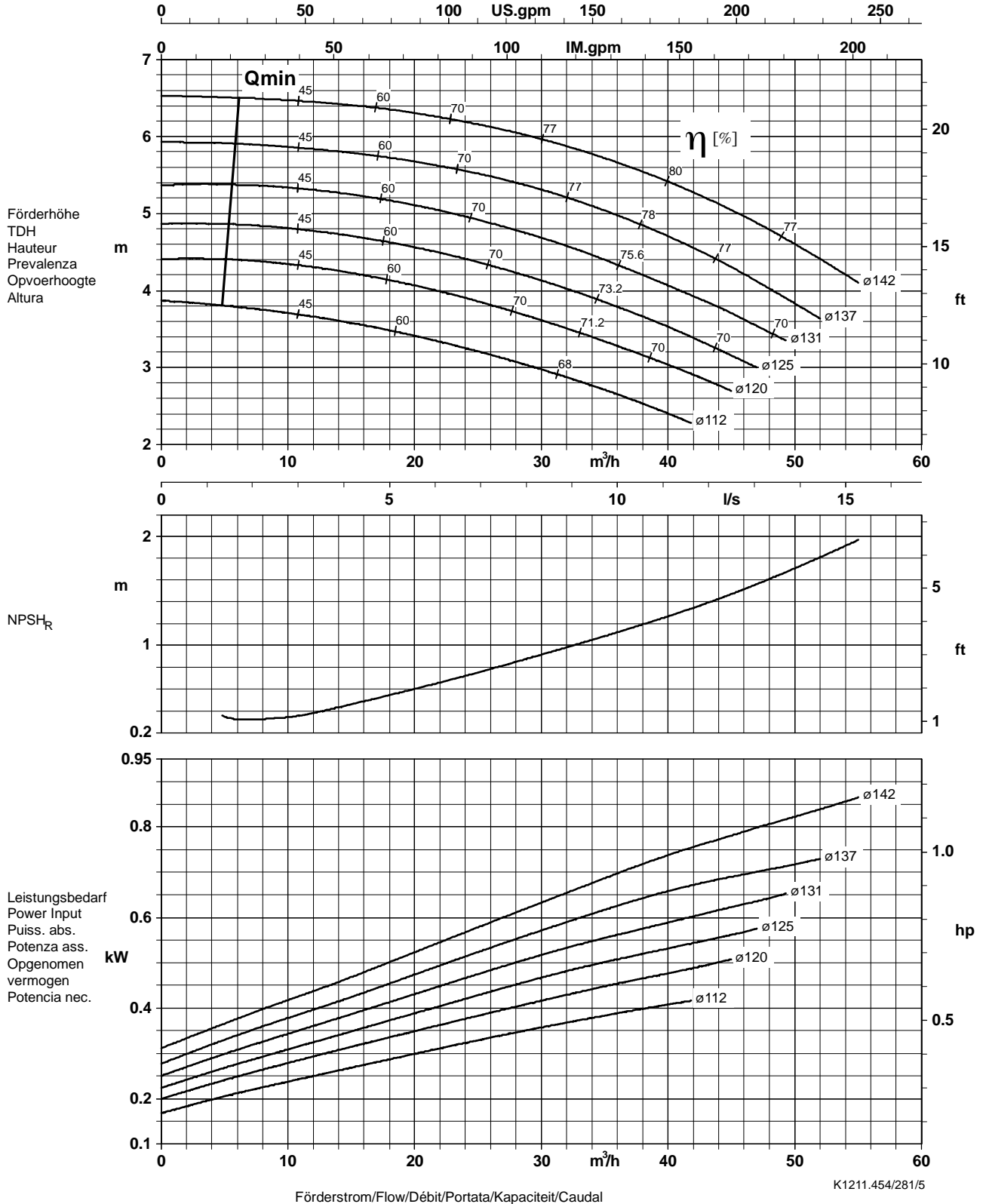

Laufradaustrittsbreite/Impeller outlet width/Largeur à la sortie de la roue 20,5 mm
 Luce della girante/Waaier uitredbreedte/Anchura de salida rodete 20,5 mm

K1211.454/281/5

Baureihe-Größe Type-Size Modèle	Tipo Serie Tipo	Nenn Drehzahl Nom. speed Vitesse nom.	Velocità di rotazione nom. Nominaal toerental Revoluciones nom.	Lauf rad- ϕ Impeller Dia. Diamètre de roue	ϕ Girante ϕ Waaier ϕ Rodete	 KSB Aktiengesellschaft Unternehmensbereich Pumpen Industrie- und Wassertechnik Postfach 1725, 67225 Frankenthal Joh.-Klein-Str. 9, 67227 Frankenthal
Etanorm 50-160 Etabloc		1450 1/min				
Projekt Project Projet	Progetto Projekt Proyecto	Angebots-Nr. Project No. No. de l'offre	Offerta-No. Offertenr. Offerta-No.	Pos.-Nr. Item No. No. de pos.	Pos.-Nr. Positiën. Pos.-Nr.	

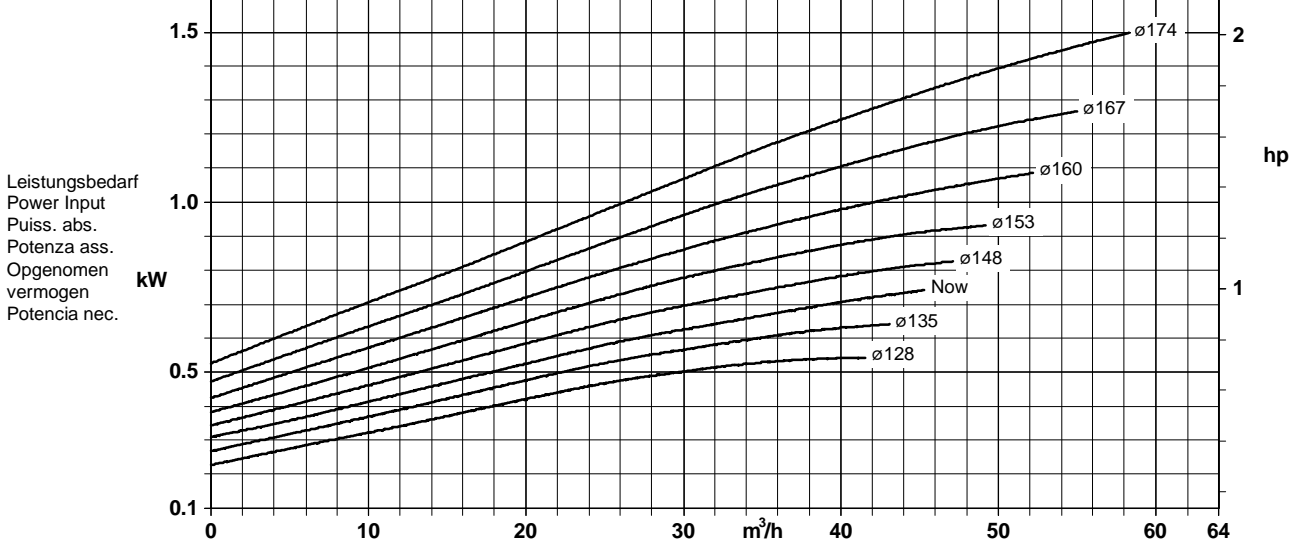
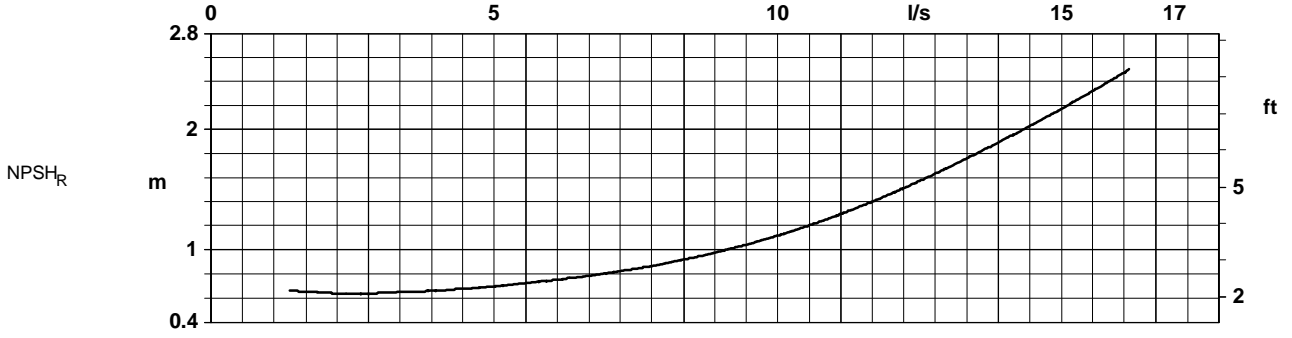
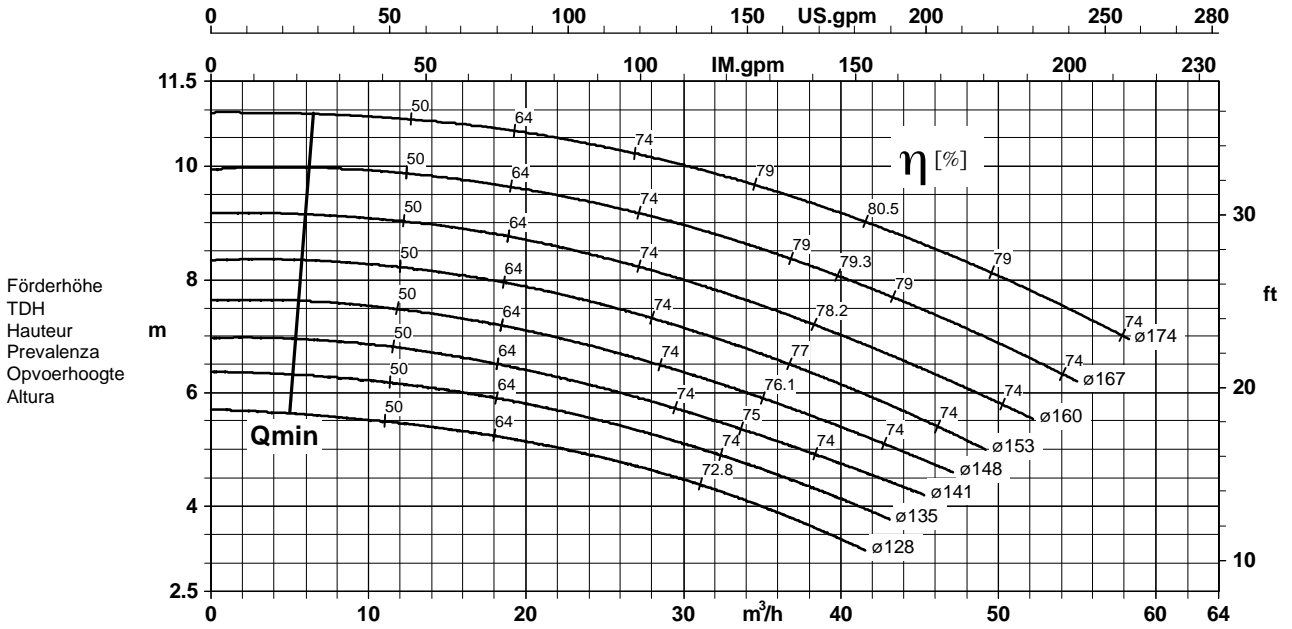

Förderstrom/Flow/Débit/Portata/Kapaciteit/Caudal K1211.454/282/5

Lauf rad austrittsbreite/Impeller outlet width/Largeur à la sortie de la roue 16,0 mm
 Luce della girante/Waaier uittredbreedte/Anchura de salida rodete 16,0 mm

Baureihe-Größe Type-Size Modèle	Tipo Serie Tipo	Nenndrehzahl Nom. speed Vitesse nom.	Velocità di rotazione nom. Nominaal toerental Revoluciones nom.	Laufrad-ø Impeller Dia. Diamètre de roue	ø Girante ø Waaier ø Rodete	 KSB Aktiengesellschaft Unternehmensbereich Pumpen Industrie- und Wassertechnik Postfach 1725, 67225 Frankenthal Joh.-Klein-Str. 9, 67227 Frankenthal
Etanorm 50-200 Etabloc		1450 1/min				
Projekt Project Projet	Progetto Projekt Proyecto	Angebots-Nr. Project No. No. de l'offre	Offerta-No. Offertenr. Offerta-No.	Pos.-Nr. Item No. No. de pos.	Pos.-Nr. Positiën. Pos.-Nr.	

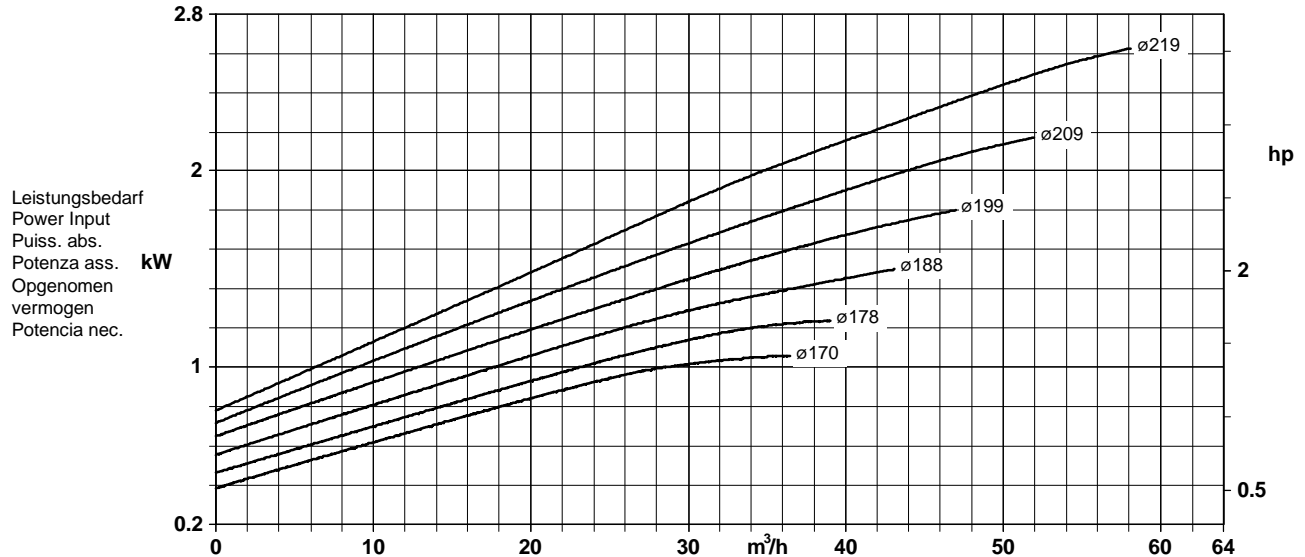
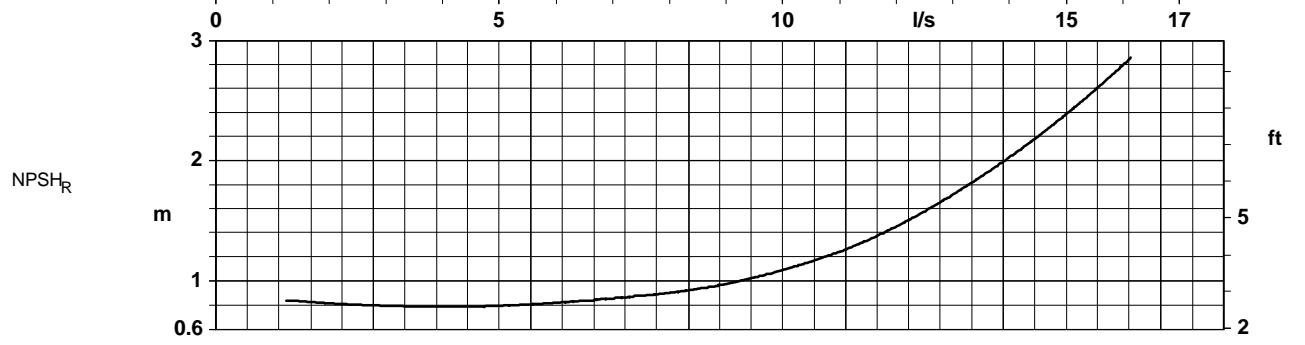
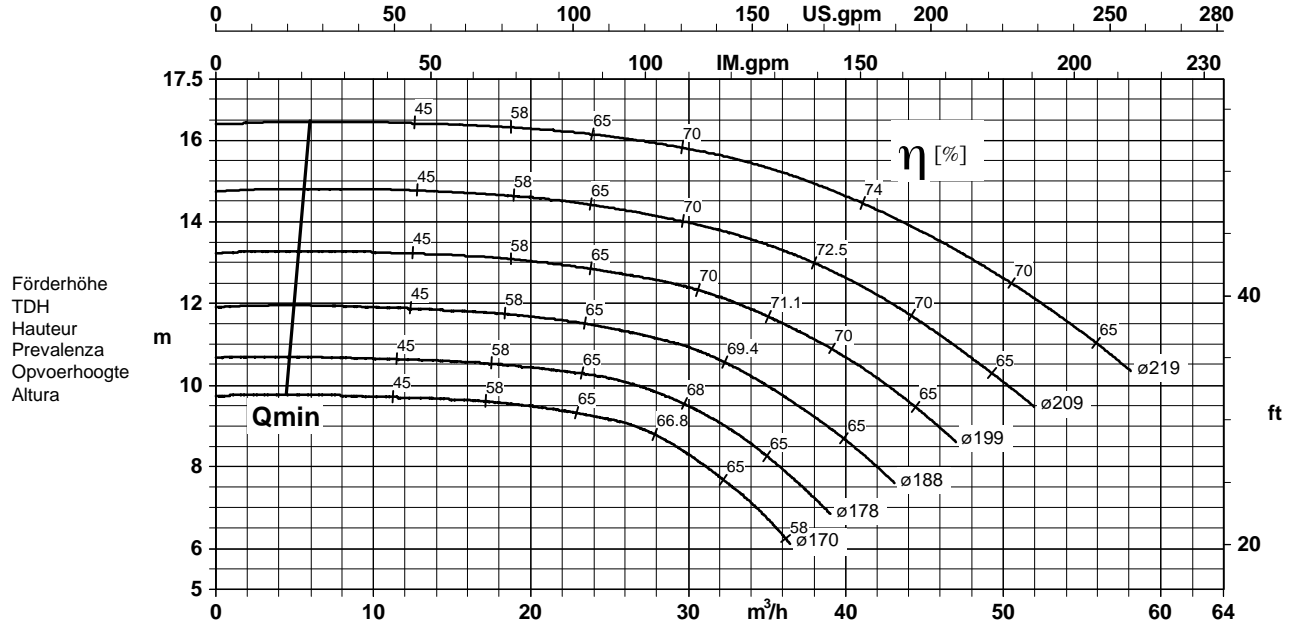

Förderstrom/Flow/Débit/Portata/Kapazität/Caudal

K1211.454/283/5

Laufradaustrittsbreite/Impeller outlet width/Largeur à la sortie de la roue 11,5 mm
 Luce della girante/Waaier uitredbreedte/Anchura de salida rodete 11,5 mm

Baureihe-Größe Type-Size Modèle	Tipo Serie Tipo	Neendrehzahl Nom. speed Vitesse nom.	Velocità di rotazione nom. Nominaal toerental Revoluciones nom.	Laufrad-ø Impeller Dia. Diamètre de roue	ø Girante ø Waaier ø Rodete	 KSB Aktiengesellschaft Unternehmensbereich Pumpen Industrie- und Wassertechnik Postfach 1725, 67225 Frankenthal Joh.-Klein-Str. 9, 67227 Frankenthal
Etanorm 50-250 Etabloc		1450 1/min				
Projekt Project Projet	Progetto Projekt Proyecto	Angebots-Nr. Project No. No. de l'offre	Offerta-No. Offertenr. Offerta-No.	Pos.-Nr. Item No. No. de pos.	Pos.-Nr. Positiën. Pos.-Nr.	

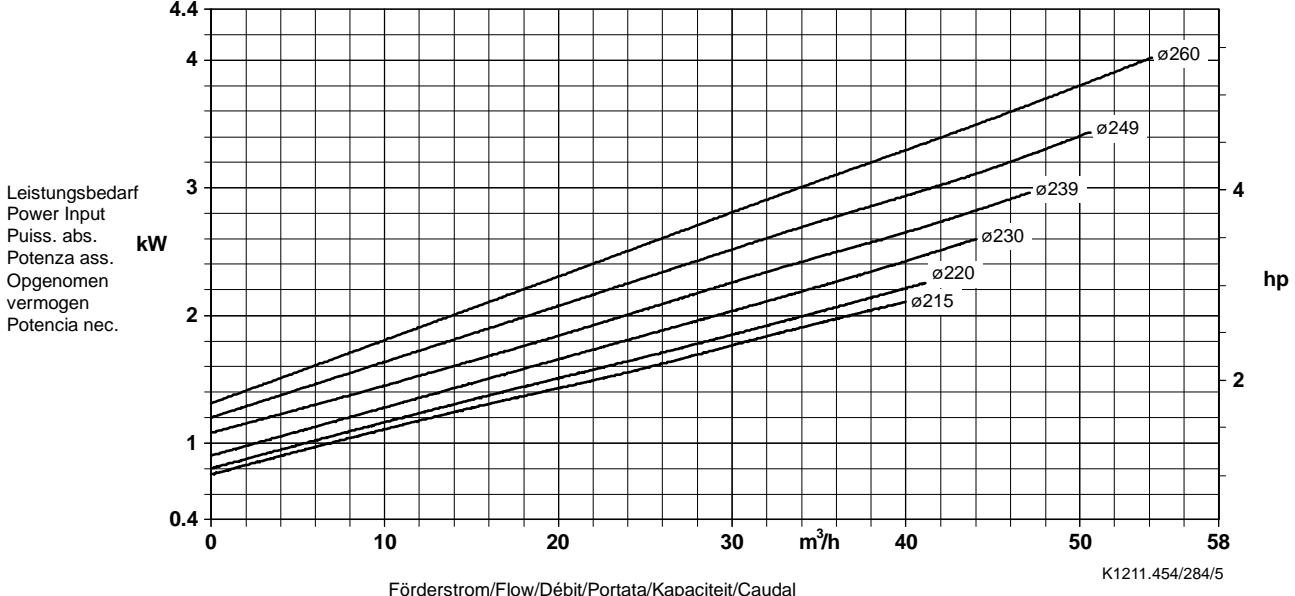
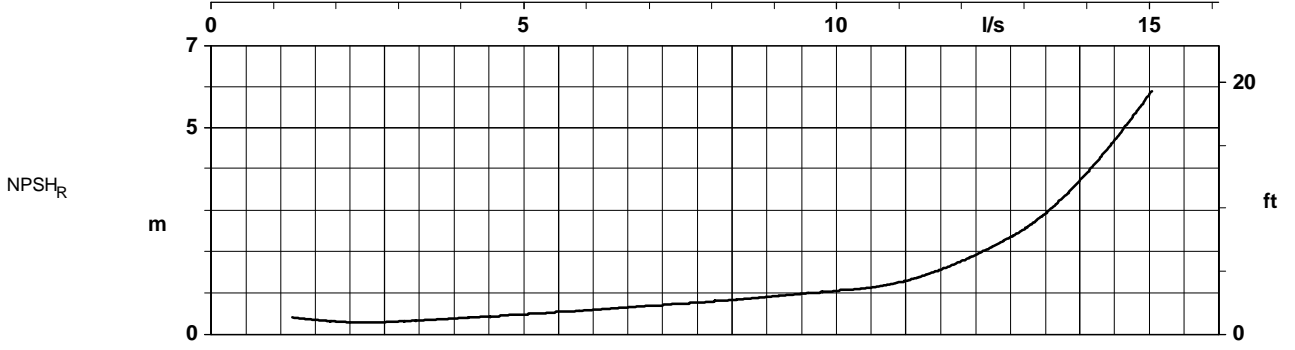
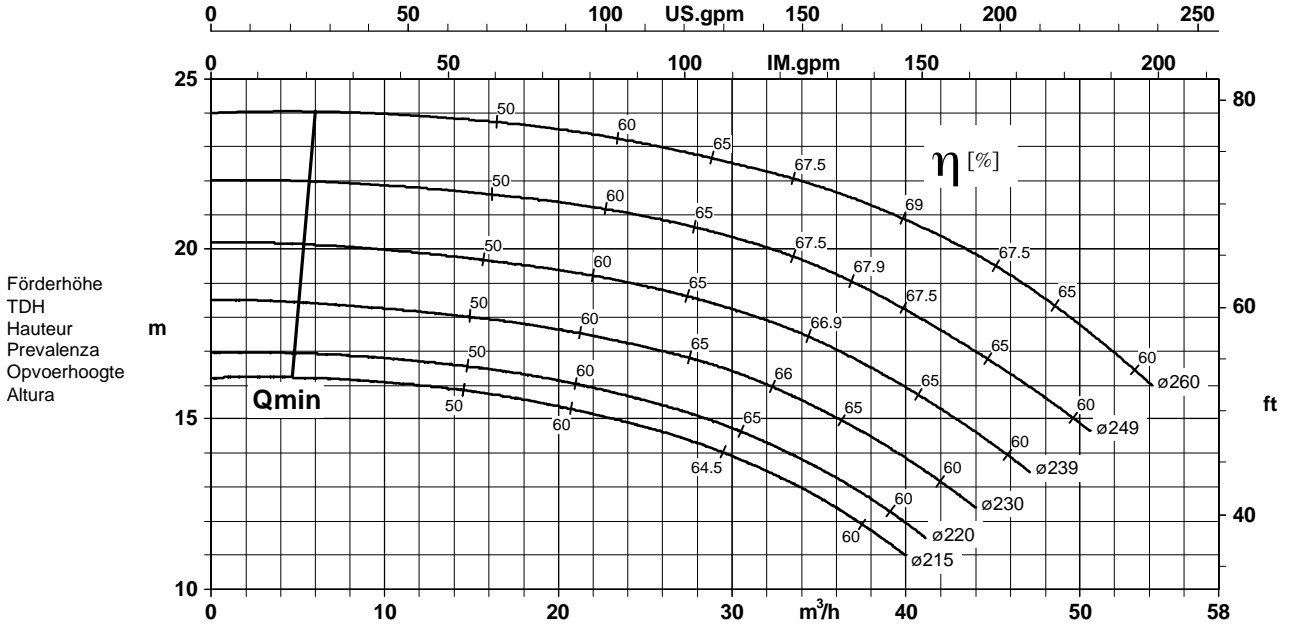

Laufradaustrittsbreite/Impeller outlet width/Largeur à la sortie de la roue 12,0 mm
 Luce della girante/Waaier uittredebreedte/Anchura de salida rodete 12,0 mm

Baureihe-Größe Type-Size Modèle	Tipo Serie Tipo	Nennzahl Nom. speed Vitesse nom.	Velocità di rotazione nom. Nominaal toerental Revoluciones nom.	Laufgrad-Ø Impeller Dia. Diamètre de roue	Ø Girante Ø Waaier Ø Rodete	 KSB Aktiengesellschaft Unternehmensbereich Pumpen Industrie- und Wassertechnik Postfach 1725, 67225 Frankenthal Joh.-Klein-Str. 9, 67227 Frankenthal
Etanorm 50-315 Etabloc		1450 1/min				
Projekt Project Projet	Progetto Projekt Proyecto	Angebots-Nr. Project No. No. de l'offre	Offerta-No. Offertenr. Offerta-No.	Pos.-Nr. Item No. No. de pos.	Pos.-Nr. Positiennr. Pos.-Nr.	

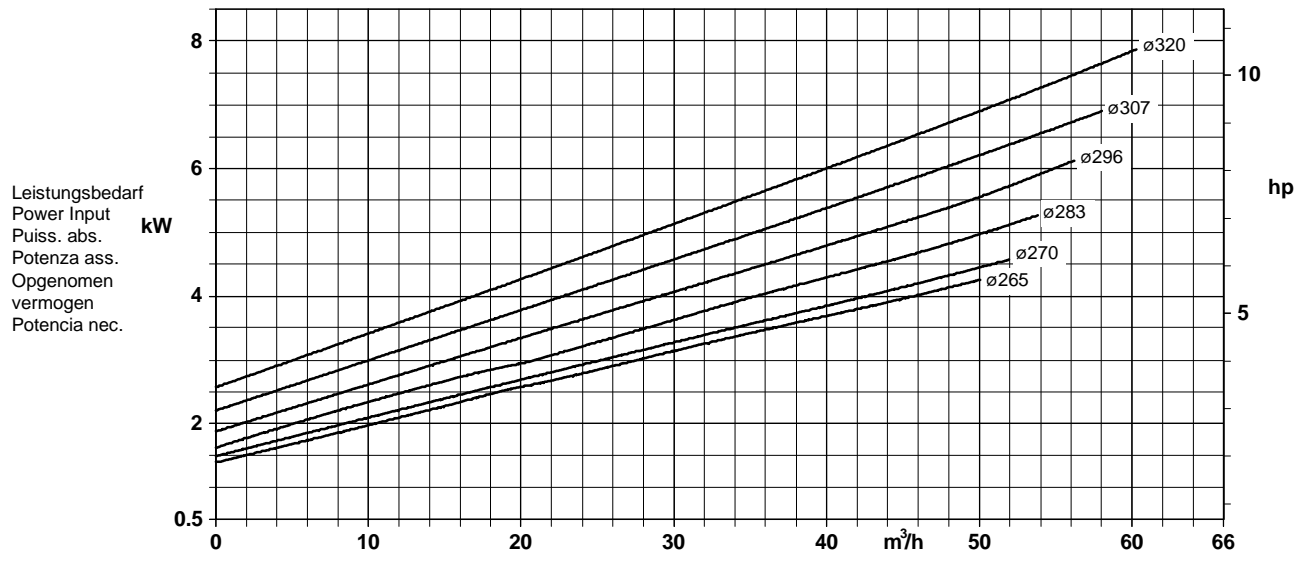
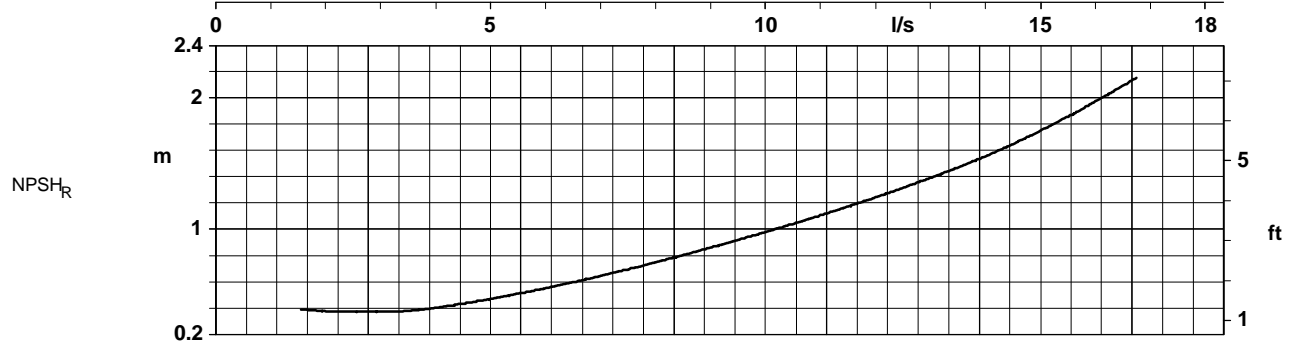
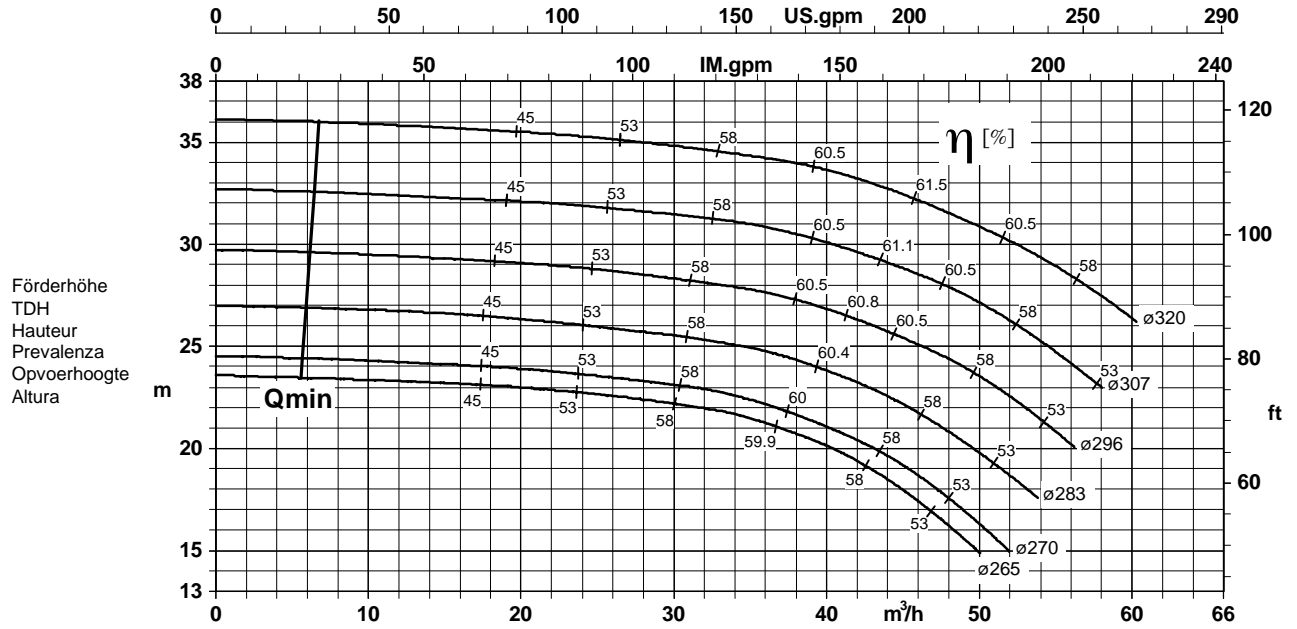

Förderstrom/Flow/Débit/Portata/Kapazität/Caudal

Laufradaustrittsbreite/Impeller outlet width/Largeur à la sortie de la roue 9,0 mm
 Luce della girante/Waaier uitredbreedte/Anchura de salida rodete 9,0 mm

K1211.454/295/5

Baureihe-Größe Type-Size Modèle	Tipo Serie Tipo	Neendrehzahl Nom. speed Vitesse nom.	Velocità di rotazione nom. Nominaal toerental Revoluciones nom.	Laufrad- ϕ Impeller Dia. Diamètre de roue	ϕ Girante ϕ Waaier ϕ Rodete	 KSB Aktiengesellschaft Unternehmensbereich Pumpen Industrie- und Wassertechnik Postfach 1725, 67225 Frankenthal Joh.-Klein-Str. 9, 67227 Frankenthal
Etanorm 65-125 Etabloc		1450 1/min				
Projekt Project Projet	Progetto Projekt Proyecto	Angebots-Nr. Project No. No. de l'offre	Offerta-No. Offertenr. Offerta-No.	Pos.-Nr. Item No. No. de pos.	Pos.-Nr. Positiën. Pos.-Nr.	

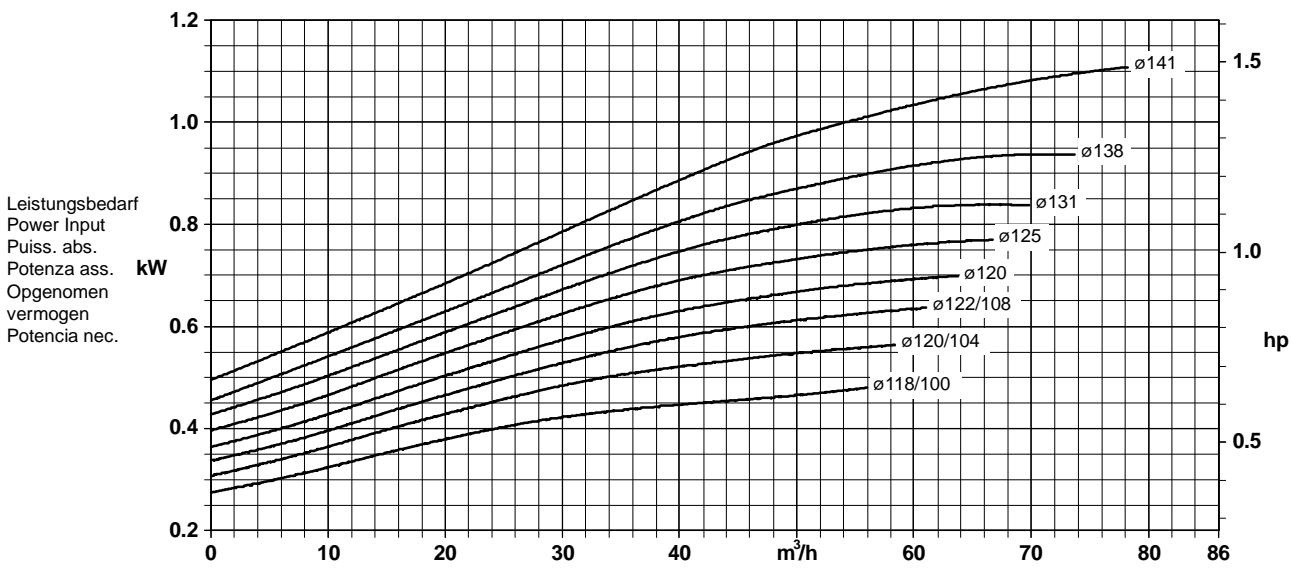
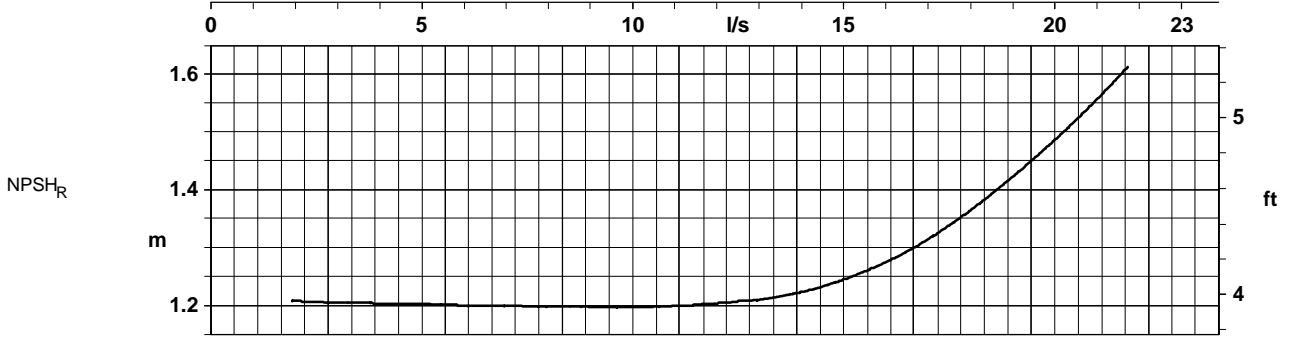
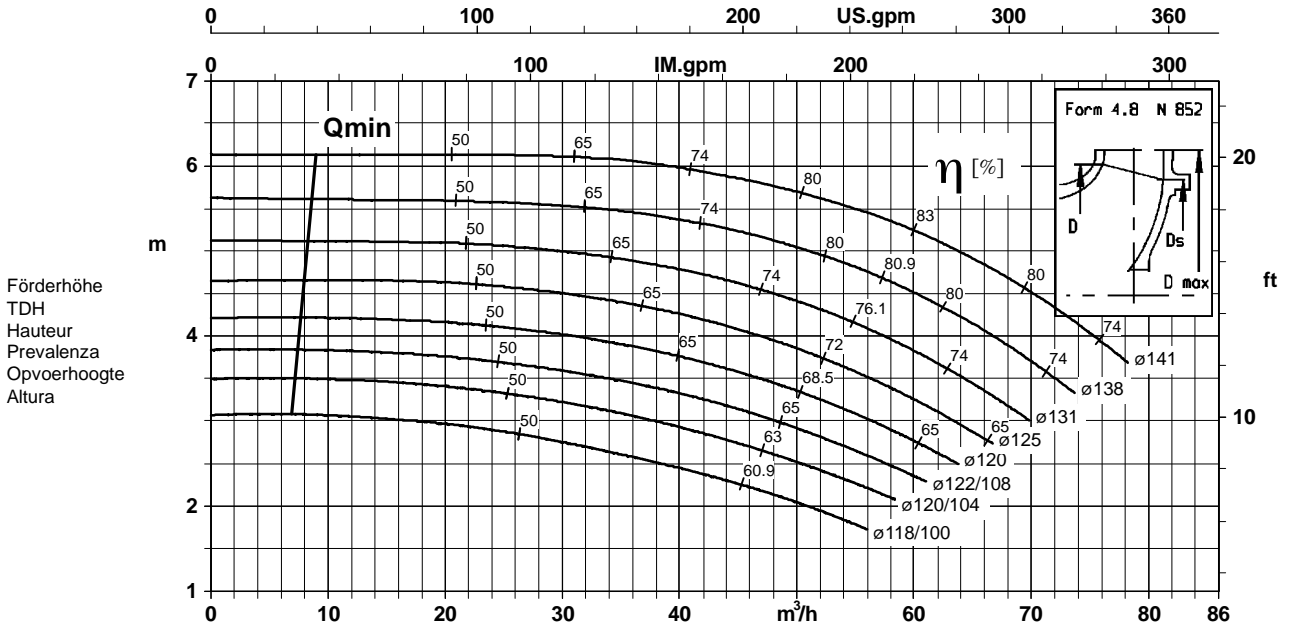

Förderstrom/Flow/Débit/Portata/Kapaciteit/Caudal

K1211.454/311/5

Laufradaustrittsbreite/Impeller outlet width/Largeur à la sortie de la roue 25,6 mm
 Luce della girante/Waaier uittredebreedte/Anchura de salida rodete 25,6 mm

Baureihe-Größe Type-Size Modèle	Tipo Serie Tipo	Neendrehzahl Nom. speed Vitesse nom.	Velocità di rotazione nom. Nominaal toerental Revoluciones nom.	Laufrad-ø Impeller Dia. Diamètre de roue	ø Girante ø Waaier ø Rodete	 KSB Aktiengesellschaft Unternehmensbereich Pumpen Industrie- und Wassertechnik Postfach 1725, 67225 Frankenthal Joh.-Klein-Str. 9, 67227 Frankenthal
Etanorm 65-160 Etabloc		1450 1/min				
Projekt Project Projet	Progetto Projekt Proyecto	Angebots-Nr. Project No. No. de l'offre	Offerta-No. Offertenr. Offerta-No.	Pos.-Nr. Item No. No. de pos.	Pos.-Nr. Positiennr. Pos.-Nr.	

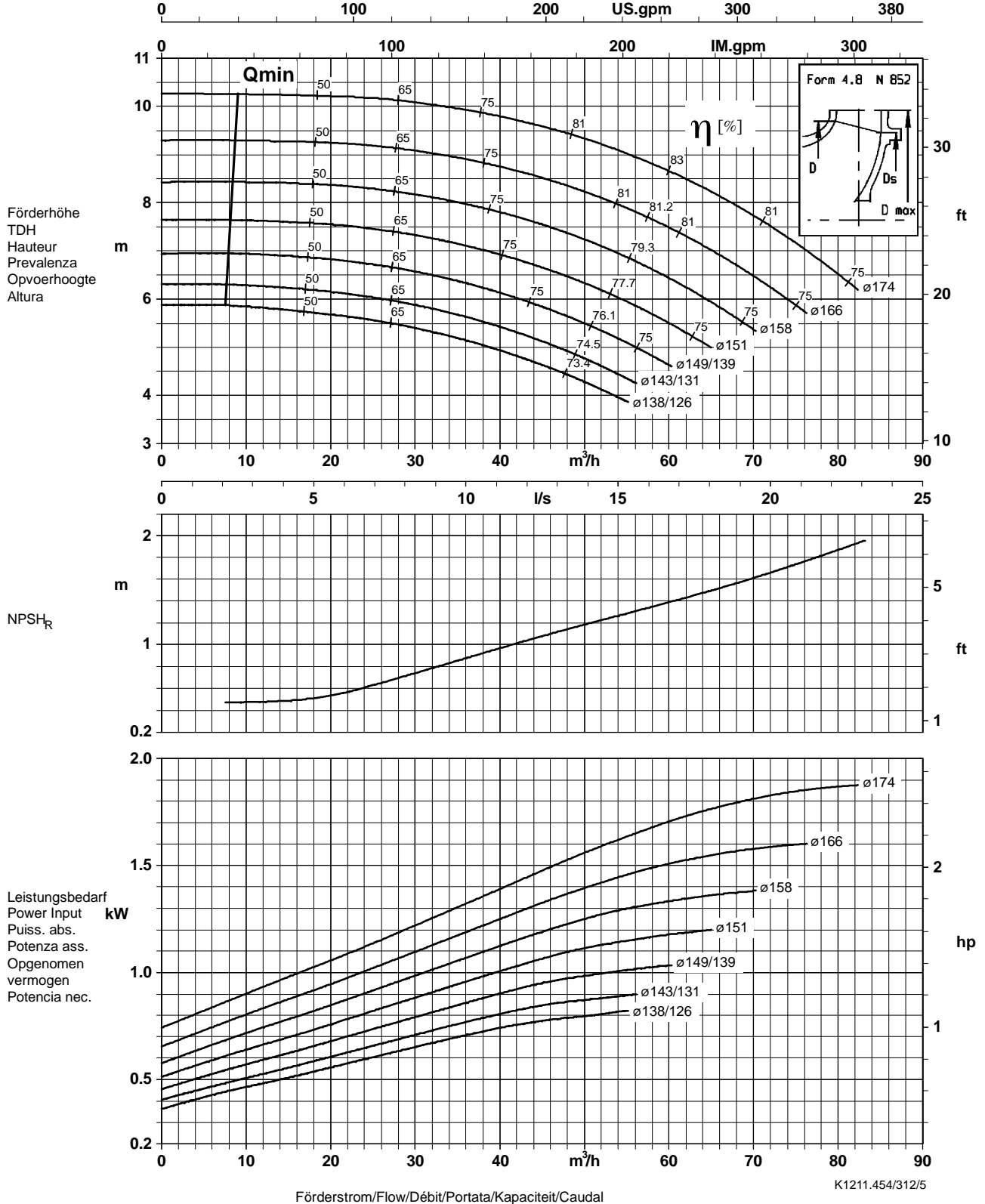

Laufradaustrittsbreite/Impeller outlet width/Largeur à la sortie de la roue 21,0 mm
 Luce della girante/Waaier uitredbreedte/Anchura de salida rodete 21,0 mm

Baureihe-Größe Type-Size Modèle	Tipo Serie Tipo	Neendrehzahl Nom. speed Vitesse nom.	Velocità di rotazione nom. Nominaal toerental Revoluciones nom.	Laufrad-ø Impeller Dia. Diamètre de roue	ø Girante ø Waaier ø Rodete	 KSB Aktiengesellschaft Unternehmensbereich Pumpen Industrie- und Wassertechnik Postfach 1725, 67225 Frankenthal Joh.-Klein-Str. 9, 67227 Frankenthal
Etanorm 65-200 Etabloc		1450 1/min				
Projekt Project Projet	Progetto Projekt Proyecto	Angebots-Nr. Project No. No. de l'offre	Offerta-No. Offertenr. Offerta-No.	Pos.-Nr. Item No. No. de pos.	Pos.-Nr. Positiën. Pos.-Nr.	

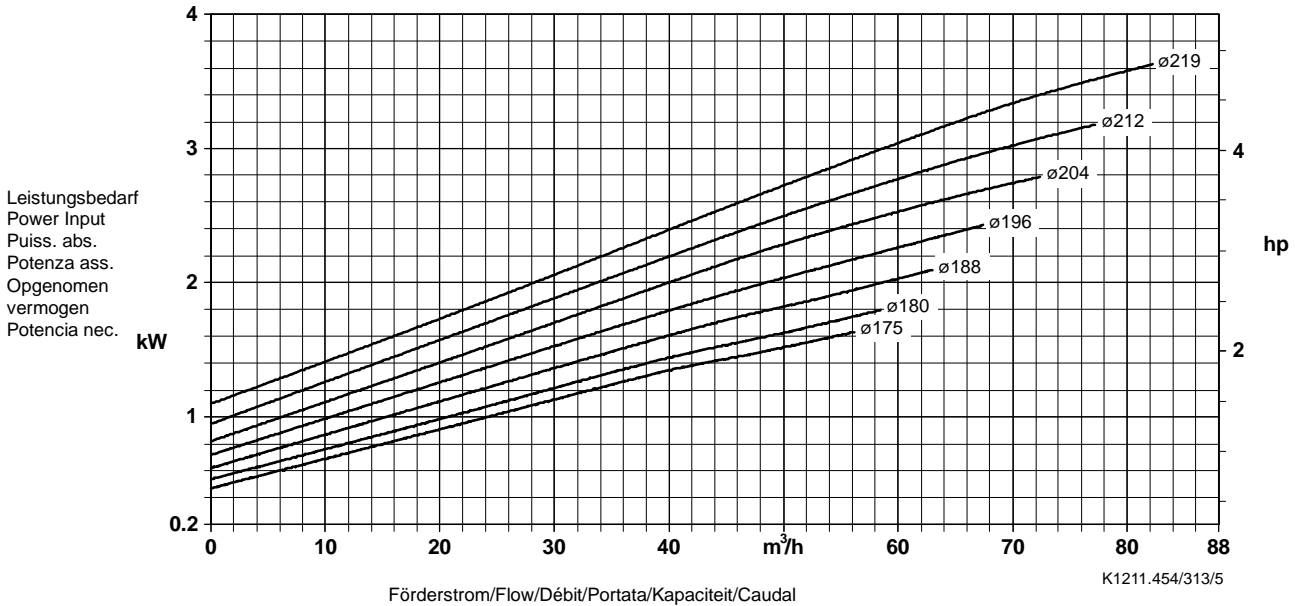
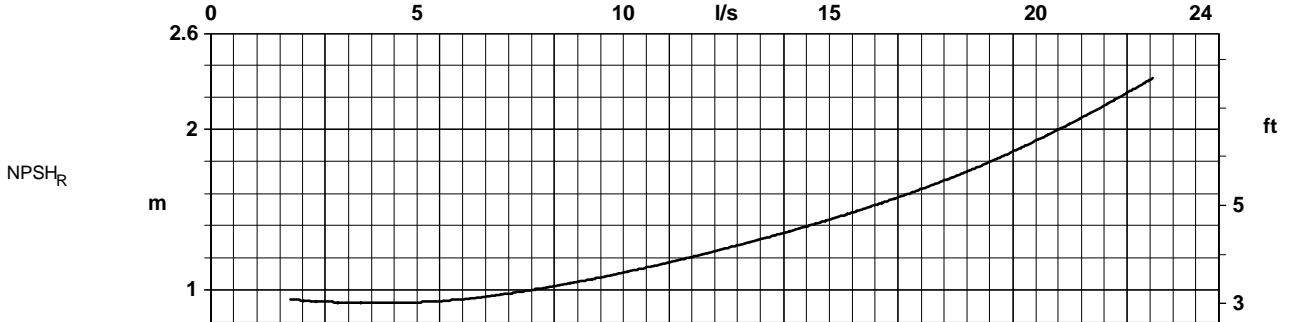
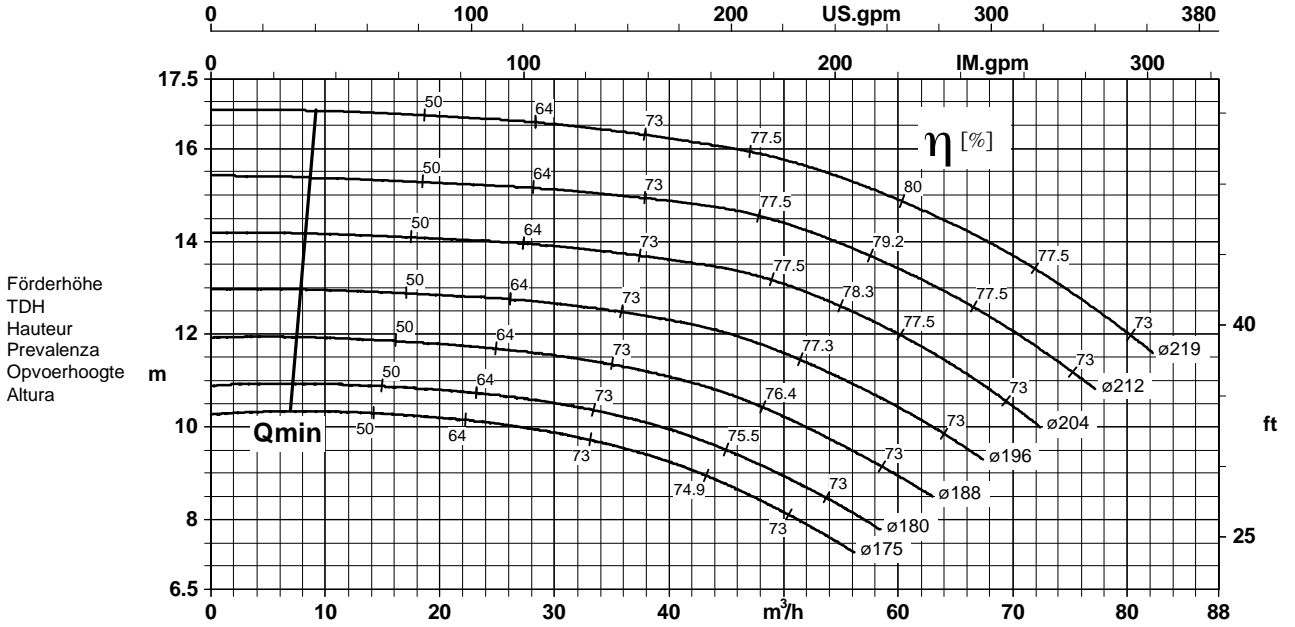

Laufradaustrittsbreite/Impeller outlet width/Largeur à la sortie de la roue 17,0 mm
 Luce della girante/Waaier uittredebreedte/Anchura de salida rodete 17,0 mm

Baureihe-Größe Type-Size Modèle	Tipo Serie Tipo	Nennzahl Nom. speed Vitesse nom.	Velocità di rotazione nom. Nominaal toerental Revoluciones nom.	Laufrad-Ø Impeller Dia. Diamètre de roue	Ø Girante Ø Waaier Ø Rodete	 KSB Aktiengesellschaft Unternehmensbereich Pumpen Industrie- und Wassertechnik Postfach 1725, 67225 Frankenthal Joh.-Klein-Str. 9, 67227 Frankenthal
Etanorm 65-250 Etabloc		1450 1/min				
Projekt Project Projet	Progetto Projekt Proyecto	Angebots-Nr. Project No. No. de l'offre	Offerta-No. Offertenr. Offerta-No.	Pos.-Nr. Item No. No. de pos.	Pos.-Nr. Positiennr. Pos.-Nr.	

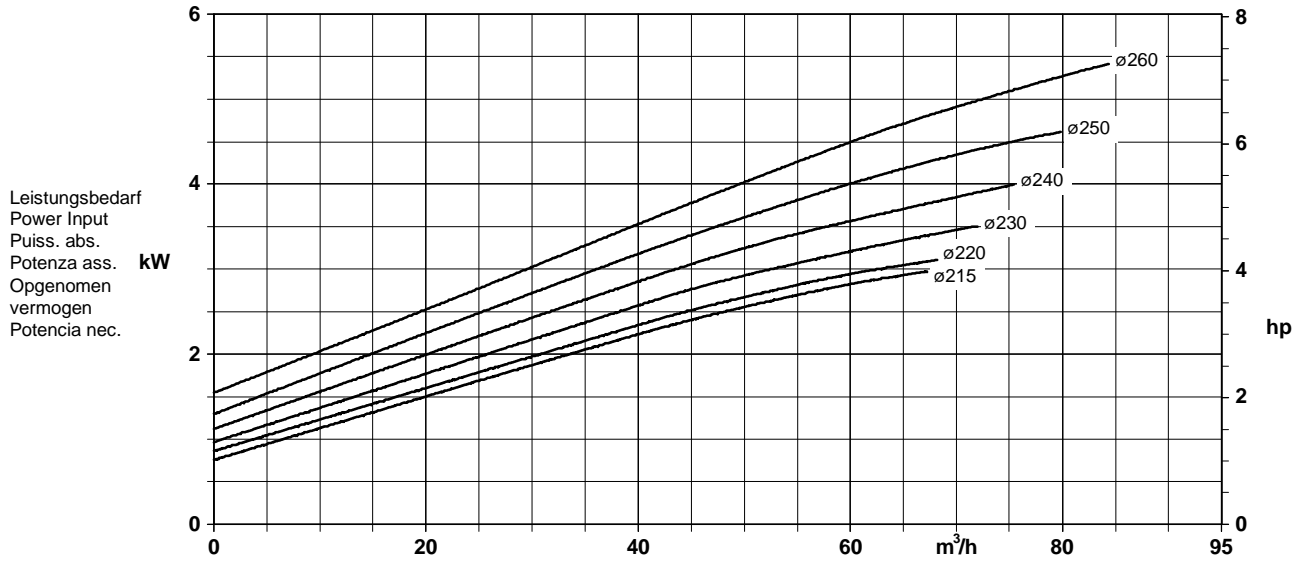
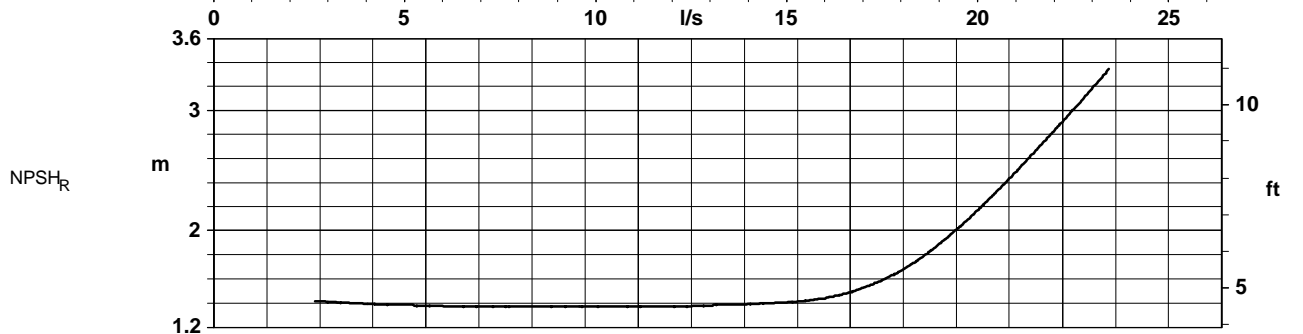
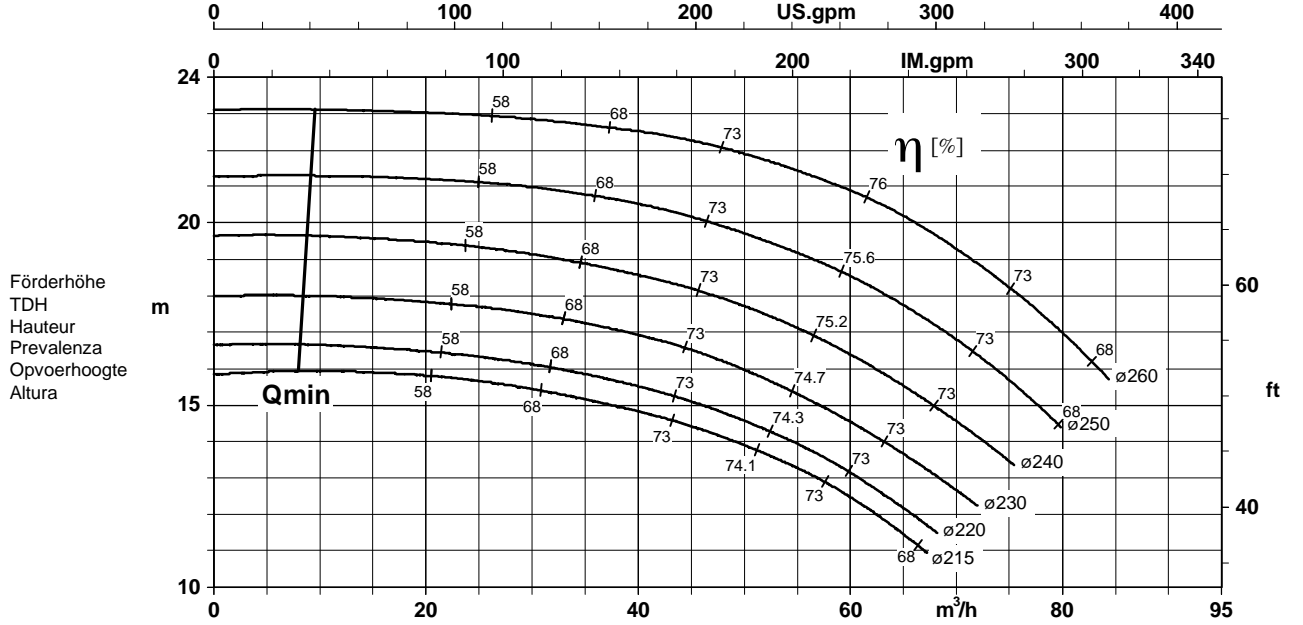

Förderstrom/Flow/Débit/Portata/Kapaciteit/Caudal

K1211.454/324/5

Laufradaustrittsbreite/Impeller outlet width/Largeur à la sortie de la roue 13,9 mm
 Luce della girante/Waaier uitredbreedte/Anchura de salida rodete 13,9 mm

Baureihe-Größe Type-Size Modèle	Tipo Serie Tipo	Neendrehzahl Nom. speed Vitesse nom.	Velocità di rotazione nom. Nominaal toerental Revoluciones nom.	Laufrad-ø Impeller Dia. Diamètre de roue	ø Girante ø Waaier ø Rodete	 KSB Aktiengesellschaft Unternehmensbereich Pumpen Industrie- und Wassertechnik Postfach 1725, 67225 Frankenthal Joh.-Klein-Str. 9, 67227 Frankenthal
Etanorm 65-315 Etabloc		1450 1/min				
Projekt Project Projet	Progetto Projekt Proyecto	Angebots-Nr. Project No. No. de l'offre	Offerta-No. Offertenr. Offerta-No.	Pos.-Nr. Item No. No. de pos.	Pos.-Nr. Positiën. Pos.-Nr.	

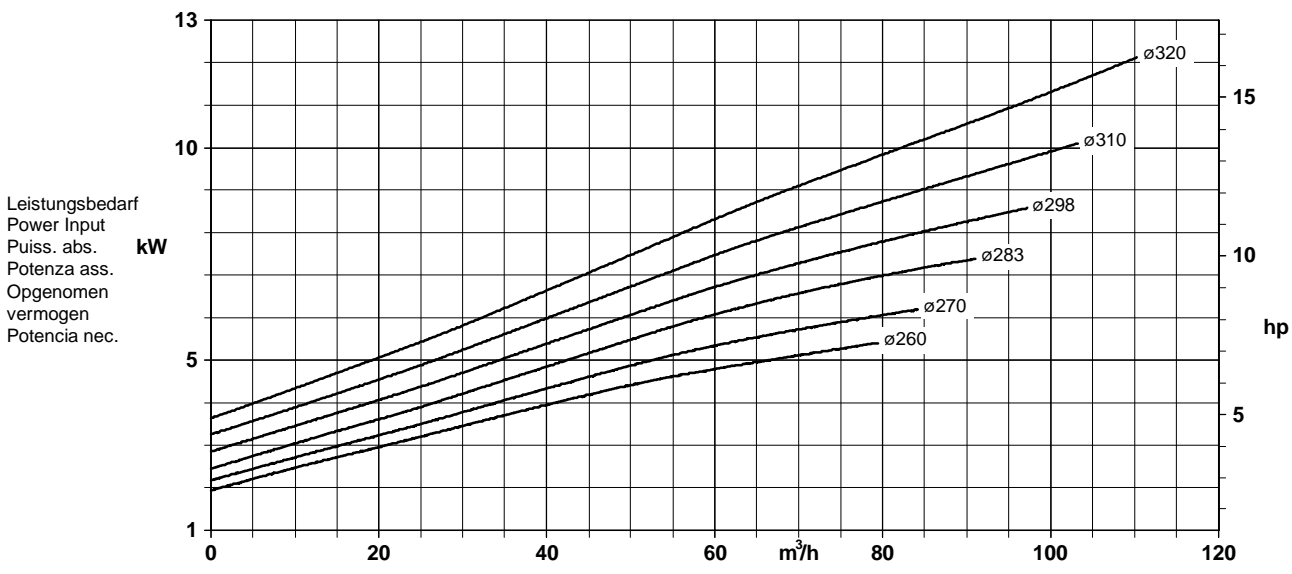
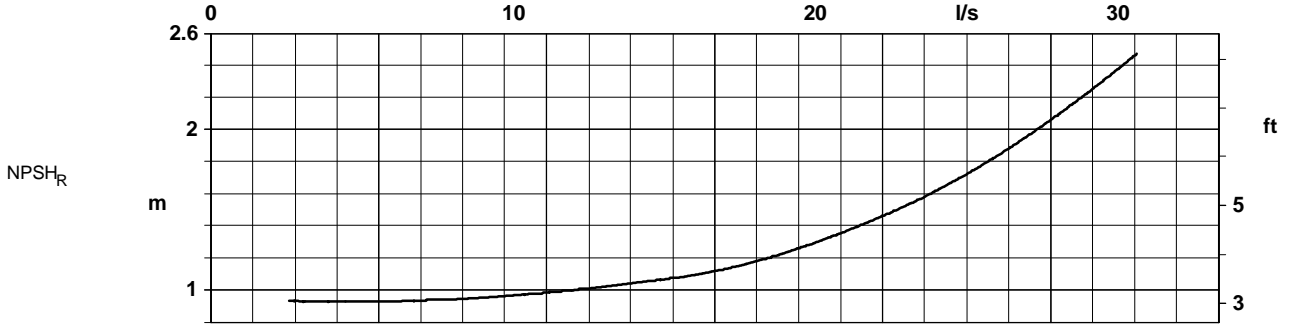
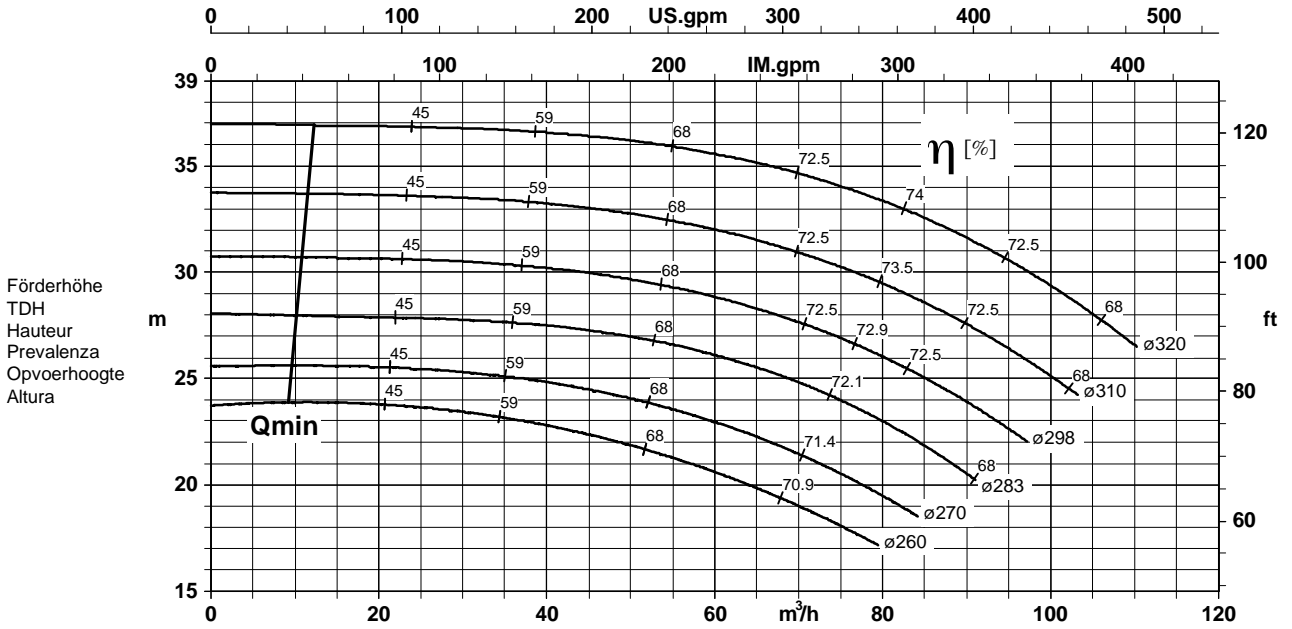

Förderstrom/Flow/Débit/Portata/Kapazität/Caudal K1211.454/345/5

Laufradaustrittsbreite/Impeller outlet width/Largeur à la sortie de la roue 13,0 mm
 Luce della girante/Waaier uittredebreedte/Anchura de salida rodete 13,0 mm

Baureihe-Größe Type-Size Modèle	Tipo Serie Tipo	Neendrehzahl Nom. speed Vitesse nom.	Velocità di rotazione nom. Nominaal toerental Revoluciones nom.	Laufrad-ø Impeller Dia. Diamètre de roue	ø Girante ø Waaier ø Rodete	 KSB Aktiengesellschaft Unternehmensbereich Pumpen Industrie- und Wassertechnik Postfach 1725, 67225 Frankenthal Joh.-Klein-Str. 9, 67227 Frankenthal
Etanorm 80-160 Etabloc		1450 1/min				
Projekt Project Projet	Progetto Projekt Proyecto	Angebots-Nr. Project No. No. de l'offre	Offerta-No. Offertenr. Offerta-No.	Pos.-Nr. Item No. No. de pos.	Pos.-Nr. Positiën. Pos.-Nr.	

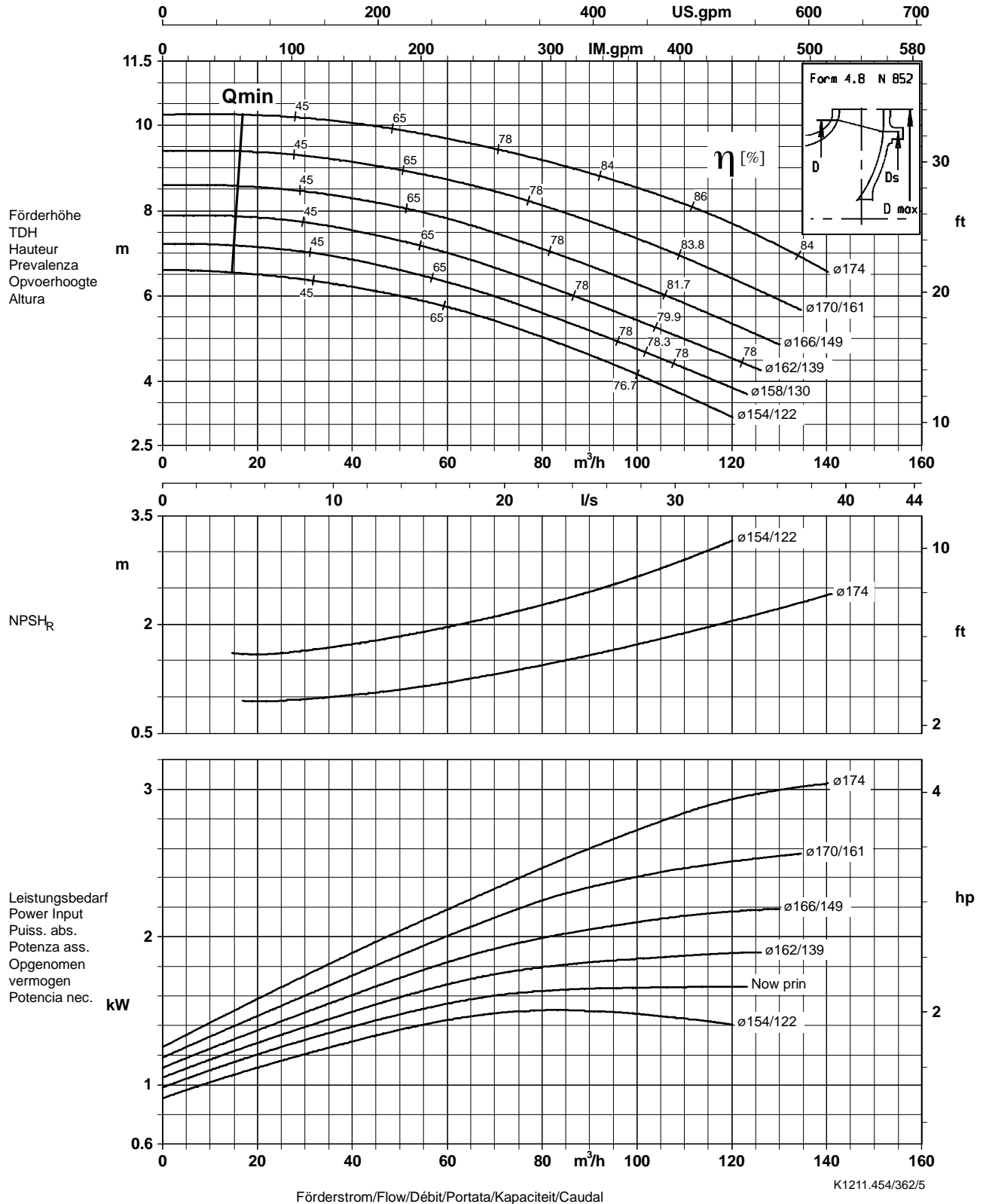

Lauftradaustrittsbreite/Impeller outlet width/Largeur à la sortie de la roue 31,6 mm
 Luce della girante/Waaier uitredbreedte/Anchura de salida rodete 31,6 mm

Baureihe-Größe Type-Size Modèle	Tipo Serie Tipo	Neendrehzahl Nom. speed Vitesse nom.	Velocità di rotazione nom. Nominaal toerental Revoluciones nom.	Laufrad- ϕ Impeller Dia. Diamètre de roue	ϕ Girante ϕ Waaier ϕ Rodete	 KSB Aktiengesellschaft Unternehmensbereich Pumpen Industrie- und Wassertechnik Postfach 1725, 67225 Frankenthal Joh.-Klein-Str. 9, 67227 Frankenthal
Etanorm 80-200 Etabloc		1450 1/min				
Projekt Project Projet	Progetto Projekt Proyecto	Angebots-Nr. Project No. No. de l'offre	Offerta-No. Offertenr. Offerta-No.	Pos.-Nr. Item No. No. de pos.	Pos.-Nr. Positiën. Pos.-Nr.	

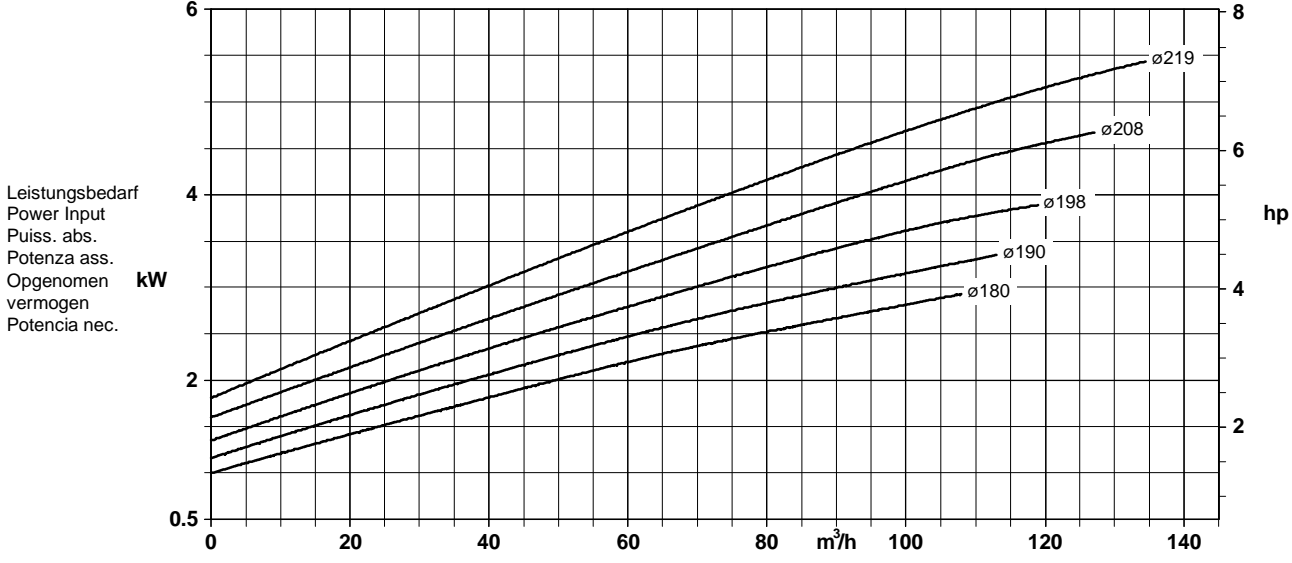
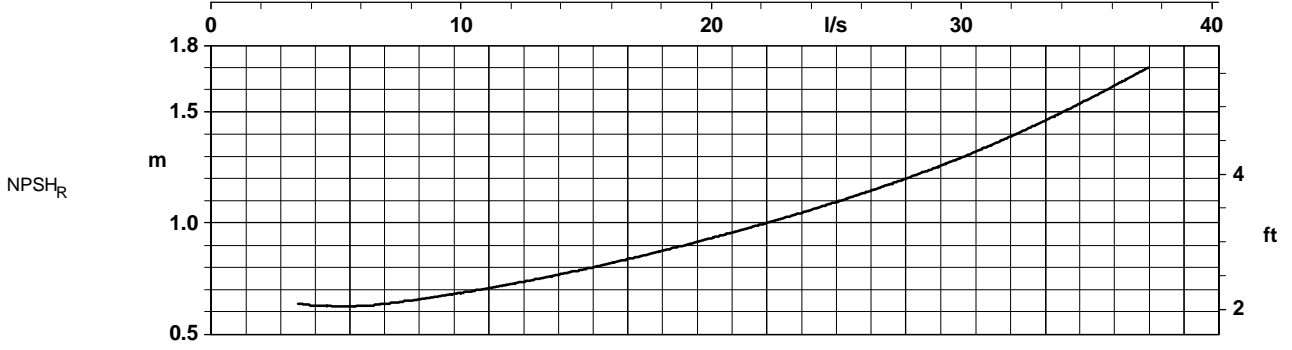
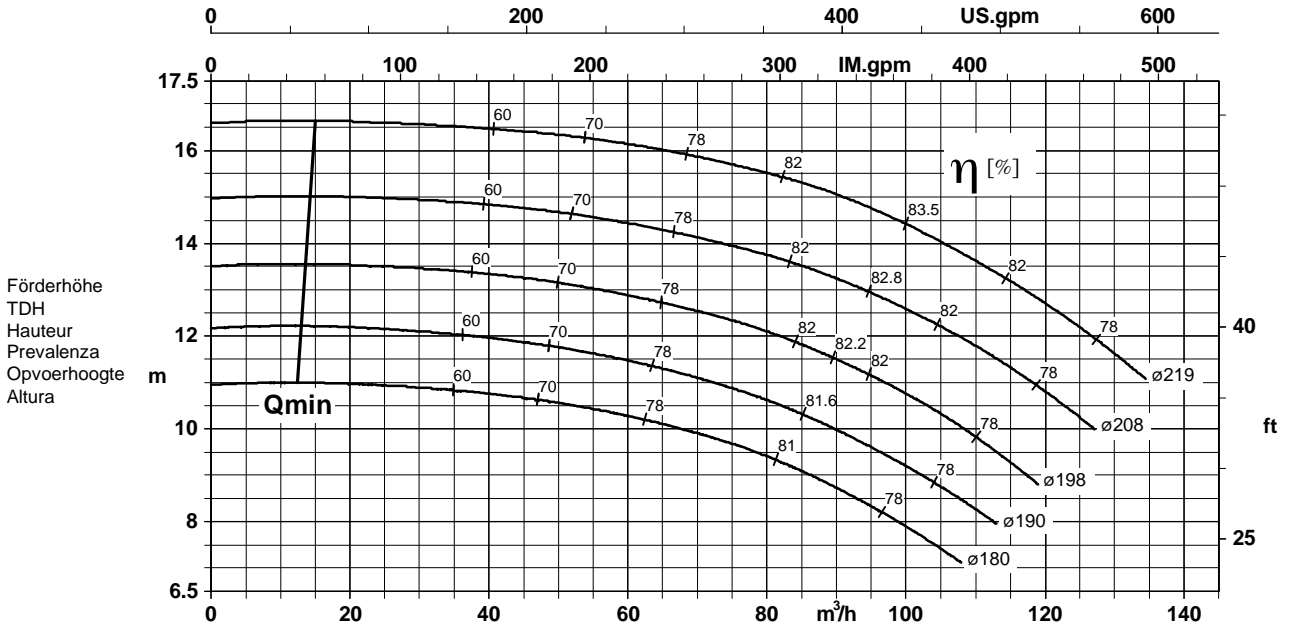

Förderstrom/Flow/Débit/Portata/Kapazität/Caudal

Laufradaustrittsbreite/Impeller outlet width/Largeur à la sortie de la roue 23,5 mm
 Luce della girante/Waaier uittredebreedte/Anchura de salida rodete 23,5 mm

K1211.454/363/5

Baureihe-Größe Type-Size Modèle	Tipo Serie Tipo	Nennzahl Nom. speed Vitesse nom.	Velocità di rotazione nom. Nominaal toerental Revoluciones nom.	Laufgrad-Ø Impeller Dia. Diamètre de roue	Ø Girante Ø Waaier Ø Rodete	 KSB Aktiengesellschaft Unternehmensbereich Pumpen Industrie- und Wassertechnik Postfach 1725, 67225 Frankenthal Joh.-Klein-Str. 9, 67227 Frankenthal
Etanorm 80-250 Etabloc		1450 1/min				
Projekt Project Projet	Progetto Projekt Proyecto	Angebots-Nr. Project No. No. de l'offre	Offerta-No. Offertenr. Offerta-No.	Pos.-Nr. Item No. No. de pos.	Pos.-Nr. Positiönr. Pos.-Nr.	

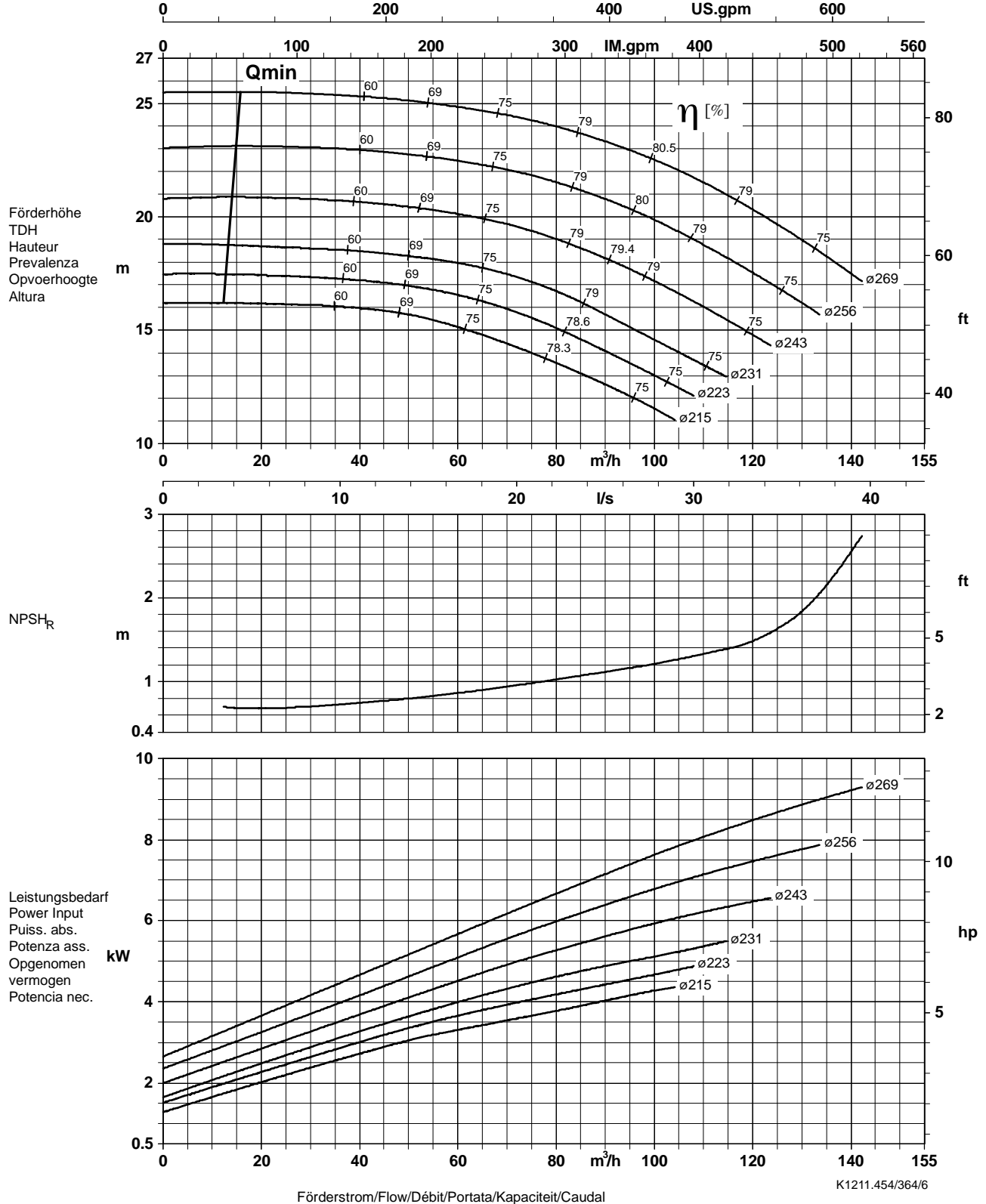

Laufradaustrittsbreite/Impeller outlet width/Largeur à la sortie de la roue 19,0 mm
 Luce della girante/Waaier uitredbreedte/Anchura de salida rodete 19,0 mm

Baureihe-Größe Type-Size Modèle	Tipo Serie Tipo	Neendrehzahl Nom. speed Vitesse nom.	Velocità di rotazione nom. Nominaal toerental Revoluciones nom.	Laufrad-ø Impeller Dia. Diamètre de roue	ø Girante ø Waaier ø Rodete	 KSB Aktiengesellschaft Unternehmensbereich Pumpen Industrie- und Wassertechnik Postfach 1725, 67225 Frankenthal Joh.-Klein-Str. 9, 67227 Frankenthal
Etanorm 80-315 Etabloc		1450 1/min				
Projekt Project Projet	Progetto Projekt Proyecto	Angebots-Nr. Project No. No. de l'offre	Offerta-No. Offertenr. Offerta-No.	Pos.-Nr. Item No. No. de pos.	Pos.-Nr. Positiën. Pos.-Nr.	

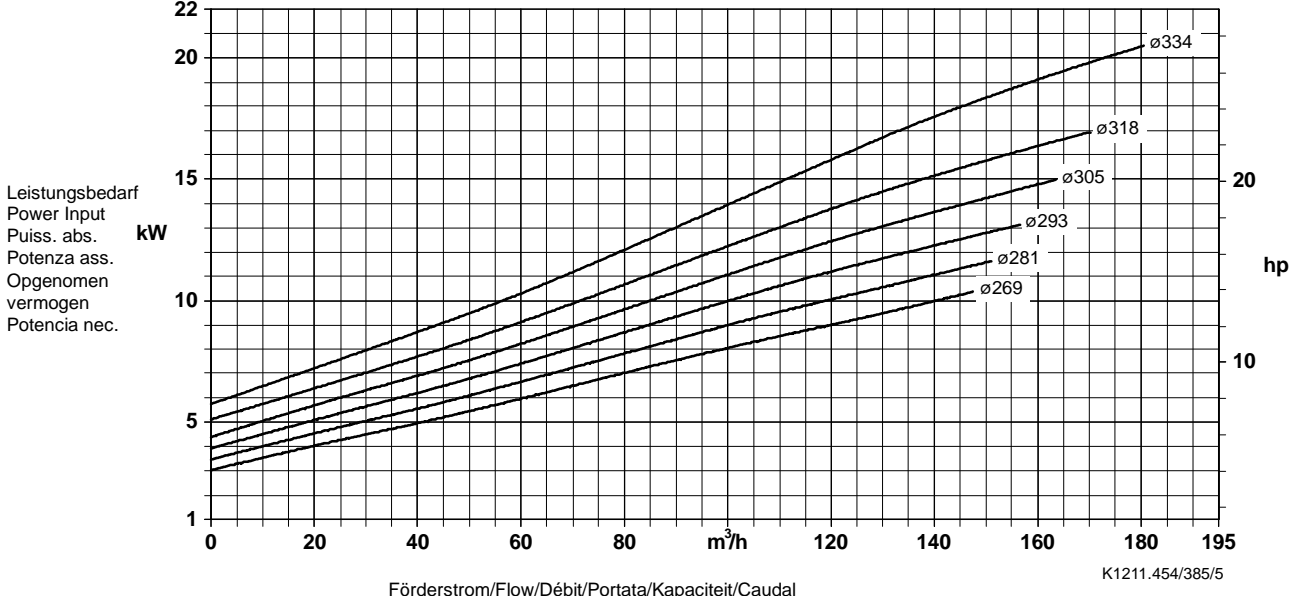
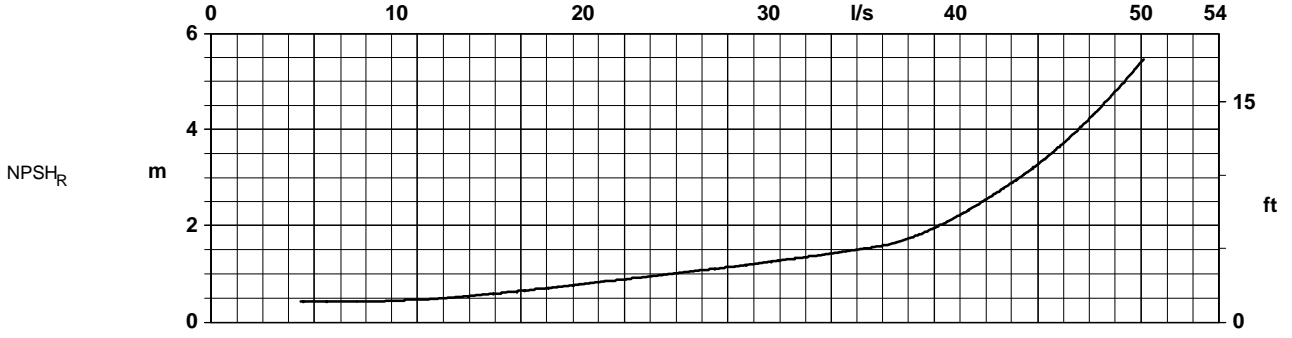
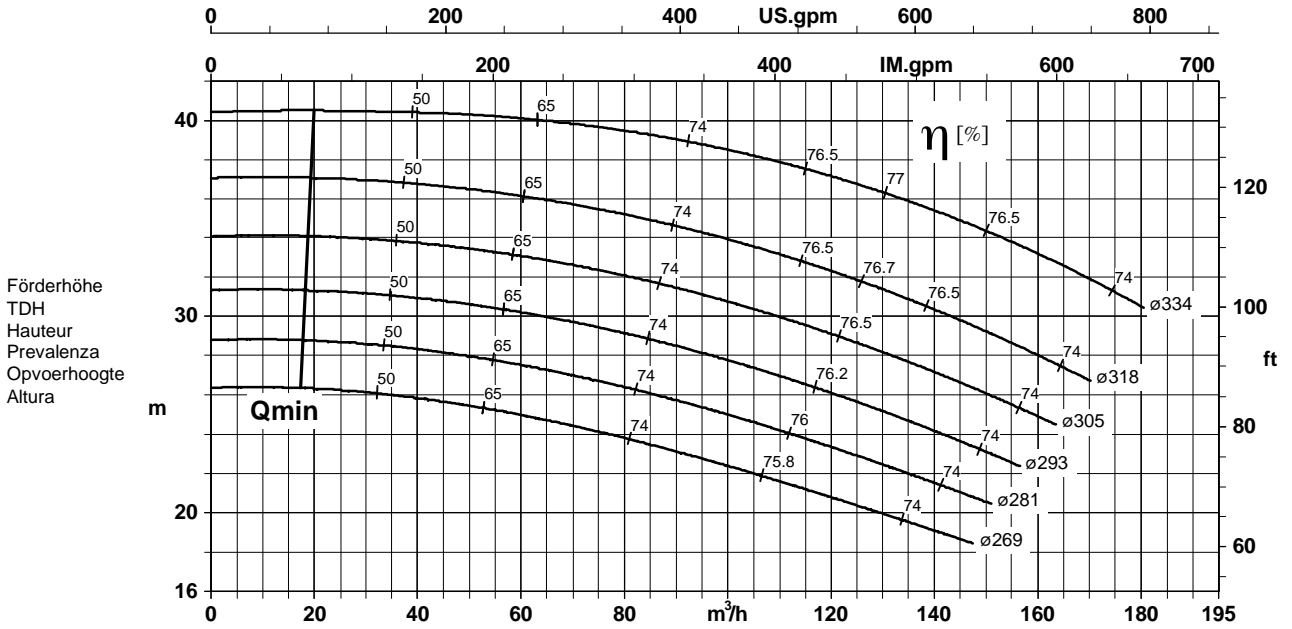

Laufradaustrittsbreite/Impeller outlet width/Largeur à la sortie de la roue 18,7 mm
 Luce della girante/Waaier uittredebreedte/Anchura de salida rodete 18,7 mm

K1211.454/385/5

Baureihe-Größe Type-Size Modèle	Tipo Serie Tipo	Nennzahl Nom. speed Vitesse nom.	Velocità di rotazione nom. Nominaal toerental Revoluciones nom.	Laufrad-ø Impeller Dia. Diamètre de roue	ø Girante ø Waaier ø Rodete	 KSB Aktiengesellschaft Unternehmensbereich Pumpen Industrie- und Wassertechnik Postfach 1725, 67225 Frankenthal Joh.-Klein-Str. 9, 67227 Frankenthal
Etanorm 80-400 Etabloc		1450 1/min				
Projekt Project Projet	Progetto Projekt Proyecto	Angebots-Nr. Project No. No. de l'offre	Offerta-No. Offertenr. Offerta-No.	Pos.-Nr. Item No. No. de pos.	Pos.-Nr. Positiën. Pos.-Nr.	

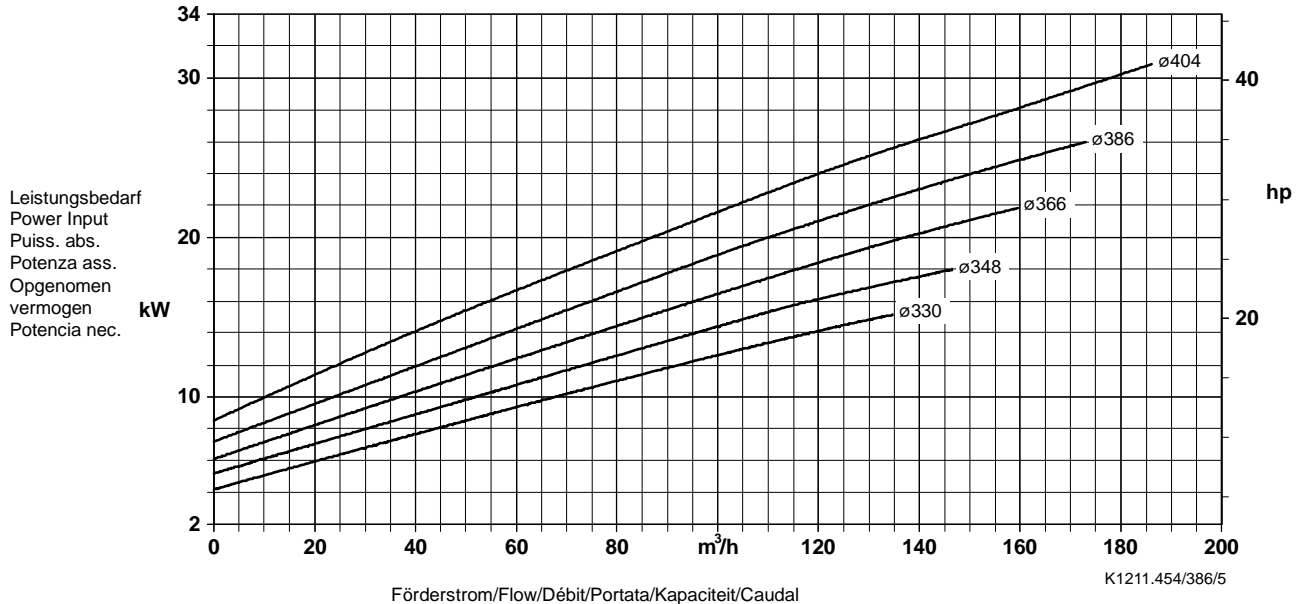
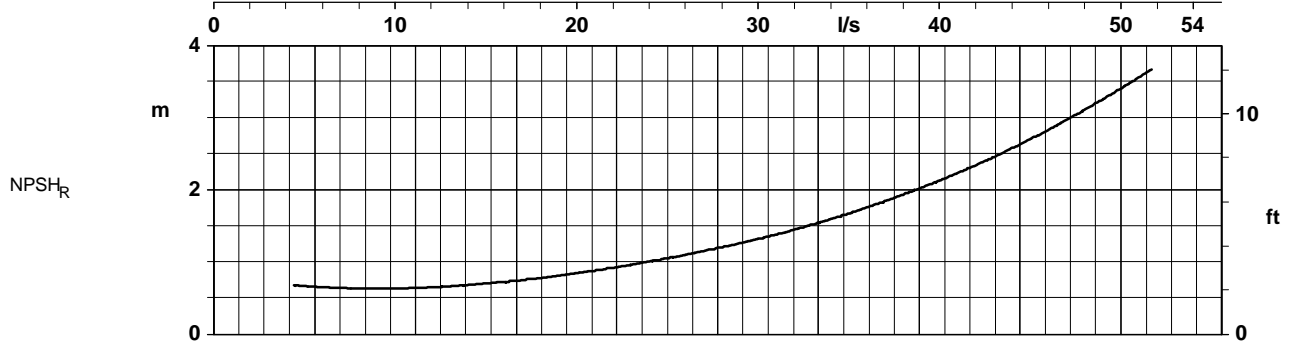
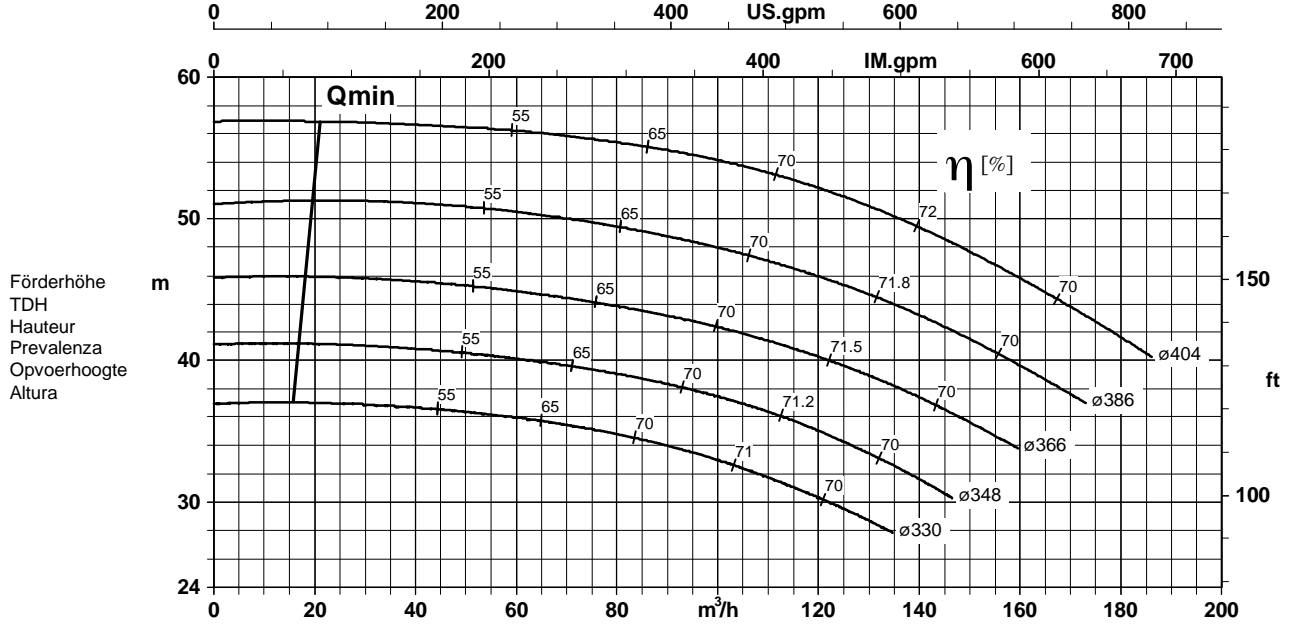

Laufradaustrittsbreite/Impeller outlet width/Largeur à la sortie de la roue 13,0 mm
 Luce della girante/Waaier uitredbreedte/Anchura de salida rodete 13,0 mm

Baureihe-Größe Type-Size Modèle	Tipo Serie Tipo	Neendrehzahl Nom. speed Vitesse nom.	Velocità di rotazione nom. Nominaal toerental Revoluciones nom.	Laufrad- ϕ Impeller Dia. Diamètre de roue	ϕ Girante ϕ Waaier ϕ Rodete	 KSB Aktiengesellschaft Unternehmensbereich Pumpen Industrie- und Wassertechnik Postfach 1725, 67225 Frankenthal Joh.-Klein-Str. 9, 67227 Frankenthal
Etanorm 100-160 Etabloc		1450 1/min				
Projekt Project Projet	Progetto Projekt Proyecto	Angebots-Nr. Project No. No. de l'offre	Offerta-No. Offertenr. Offerta-No.	Pos.-Nr. Item No. No. de pos.	Pos.-Nr. Positiën. Pos.-Nr.	

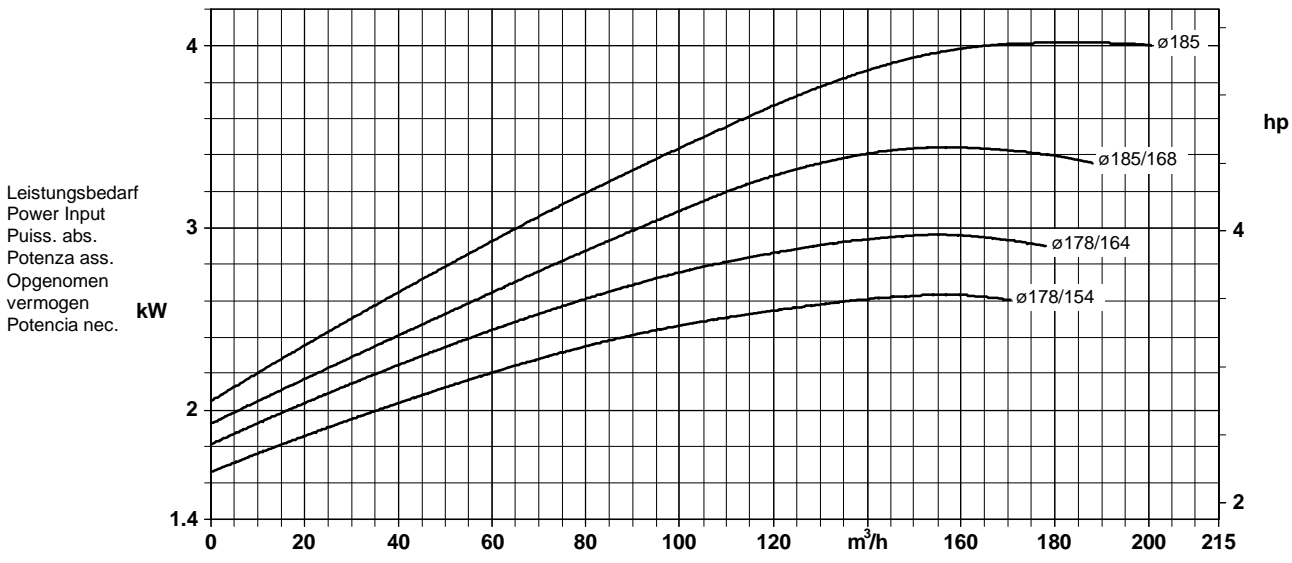
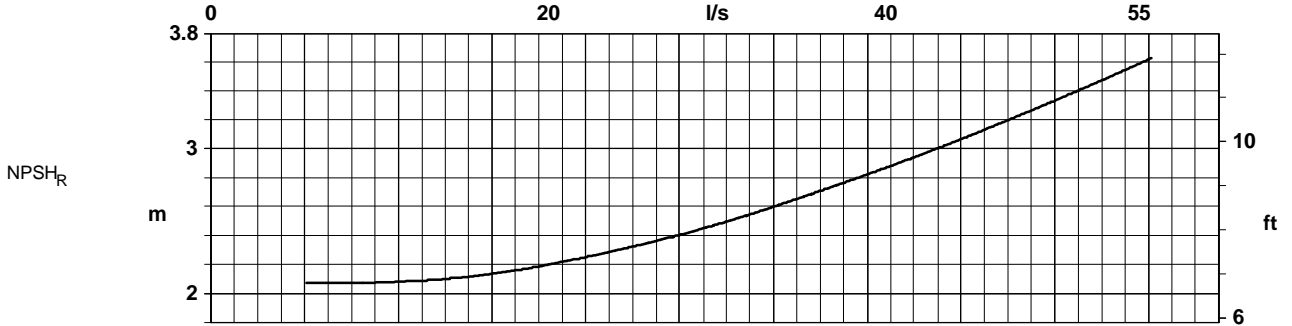
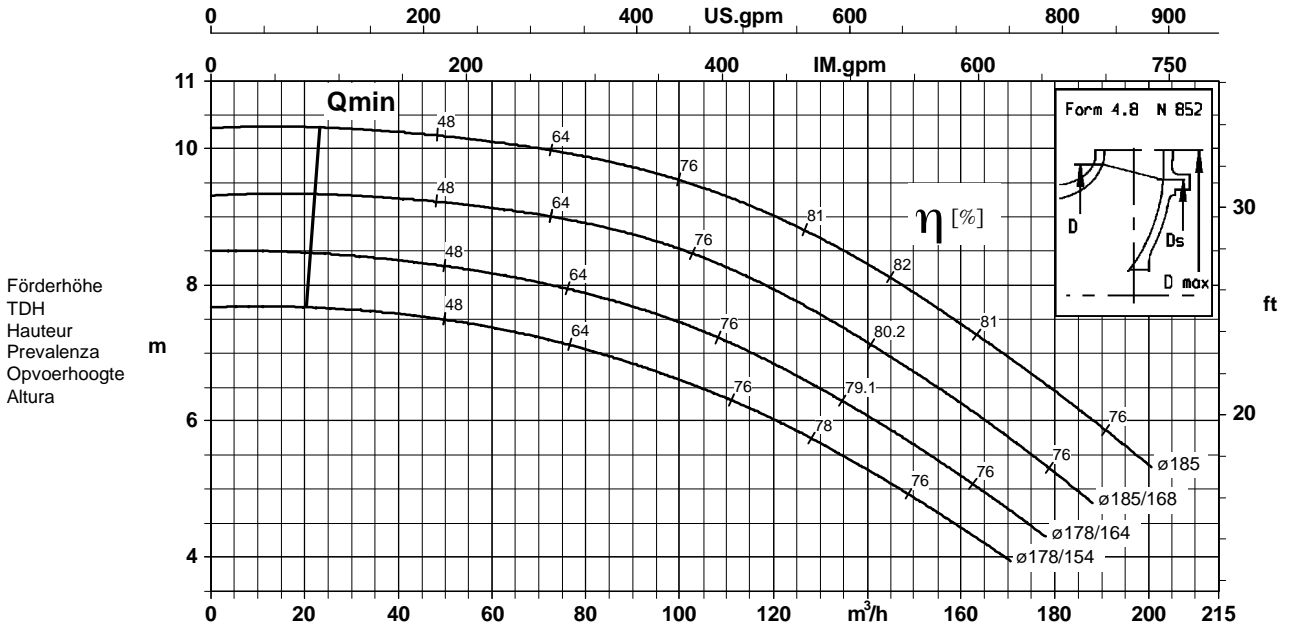

Förderstrom/Flow/Débit/Portata/Kapaciteit/Caudal

Laufradaustrittsbreite/Impeller outlet width/Largeur à la sortie de la roue 36,0 mm
 Luce della girante/Waaier uittebreedte/Anchura de salida rodete 36,0 mm

K1211.454/391/5

Baureihe-Größe Type-Size Modèle	Tipo Serie Tipo	Nennzahl Nom. speed Vitesse nom.	Velocità di rotazione nom. Nominaal toerental Revoluciones nom.	Laufrad-Ø Impeller Dia. Diamètre de roue	Ø Girante Ø Waaier Ø Rodete	 KSB Aktiengesellschaft Unternehmensbereich Pumpen Industrie- und Wassertechnik Postfach 1725, 67225 Frankenthal Joh.-Klein-Str. 9, 67227 Frankenthal
Etanorm 100-200 Etabloc		1450 1/min				
Projekt Project Projet	Progetto Projekt Proyecto	Angebots-Nr. Project No. No. de l'offre	Offerta-No. Offertenr. Offerta-No.	Pos.-Nr. Item No. No. de pos.	Pos.-Nr. Positiennr. Pos.-Nr.	

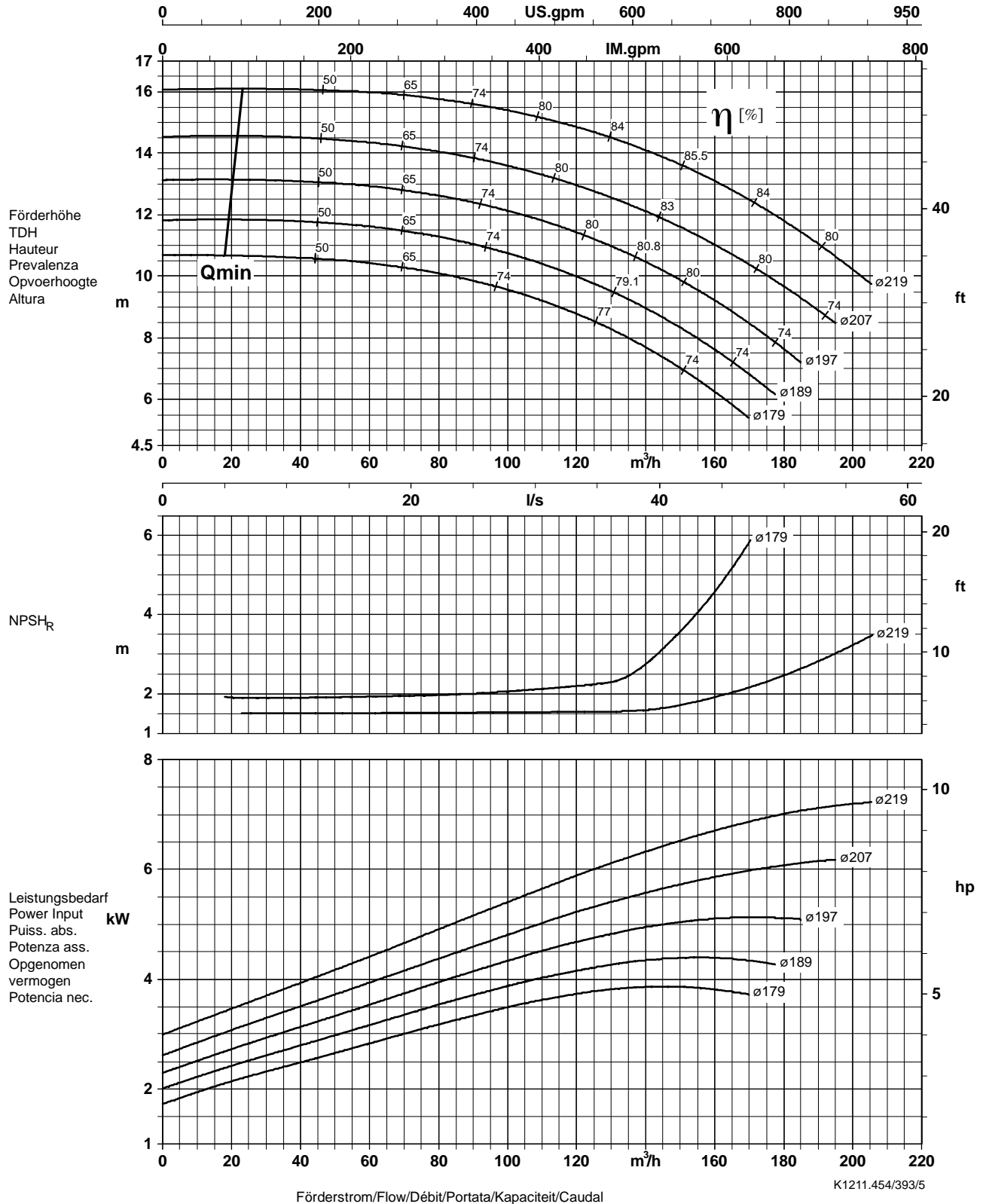

Lauftradaustrittsbreite/Impeller outlet width/Largeur à la sortie de la roue 32,5 mm
 Luce della girante/Waaier uitredbreedte/Anchura de salida rodete 32,5 mm

K1211.454/393/5

Baureihe-Größe Type-Size Modèle	Tipo Serie Tipo	Nenn Drehzahl Nom. speed Vitesse nom.	Velocità di rotazione nom. Nominaal toerental Revoluciones nom.	Lauf rad- ϕ Impeller Dia. Diamètre de roue	ϕ Girante ϕ Waaier ϕ Rodete	 KSB Aktiengesellschaft Unternehmensbereich Pumpen Industrie- und Wassertechnik Postfach 1725, 67225 Frankenthal Joh.-Klein-Str. 9, 67227 Frankenthal
Etanorm 100-250 Etabloc		1450 1/min				
Projekt Project Projet	Progetto Projekt Proyecto	Angebots-Nr. Project No. No. de l'offre	Offerta-No. Offertenr. Offerta-No.	Pos.-Nr. Item No. No. de pos.	Pos.-Nr. Positiëntr. Pos.-Nr.	

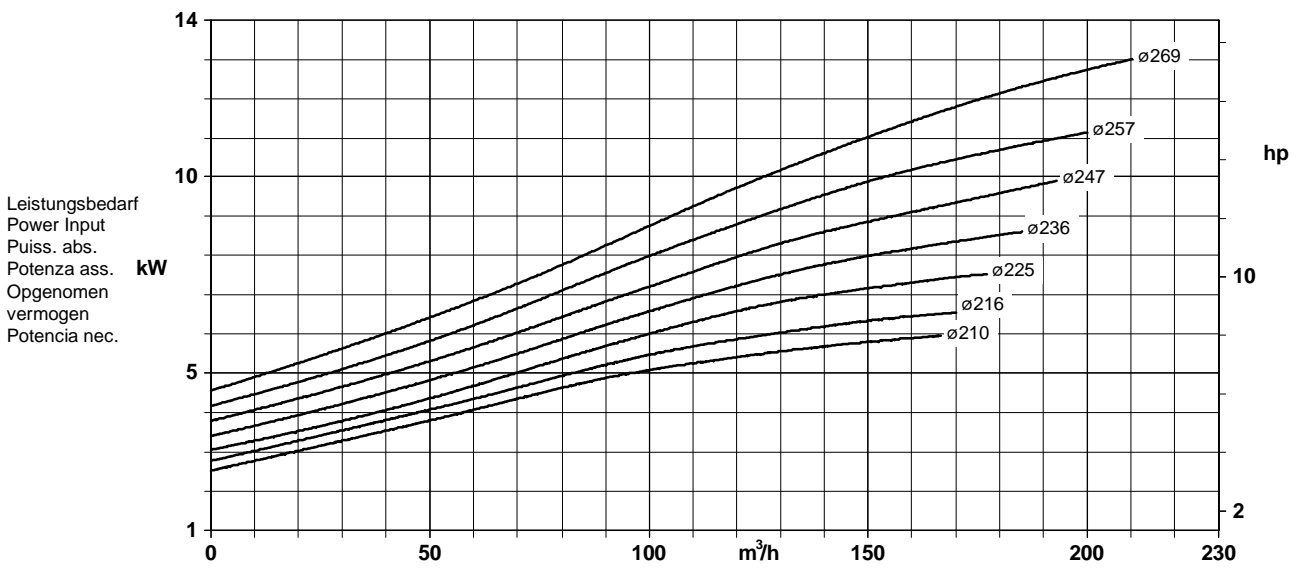
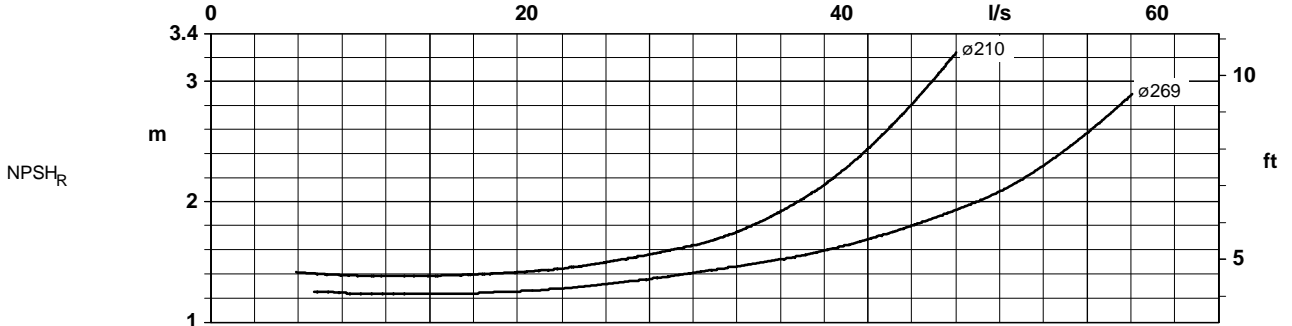
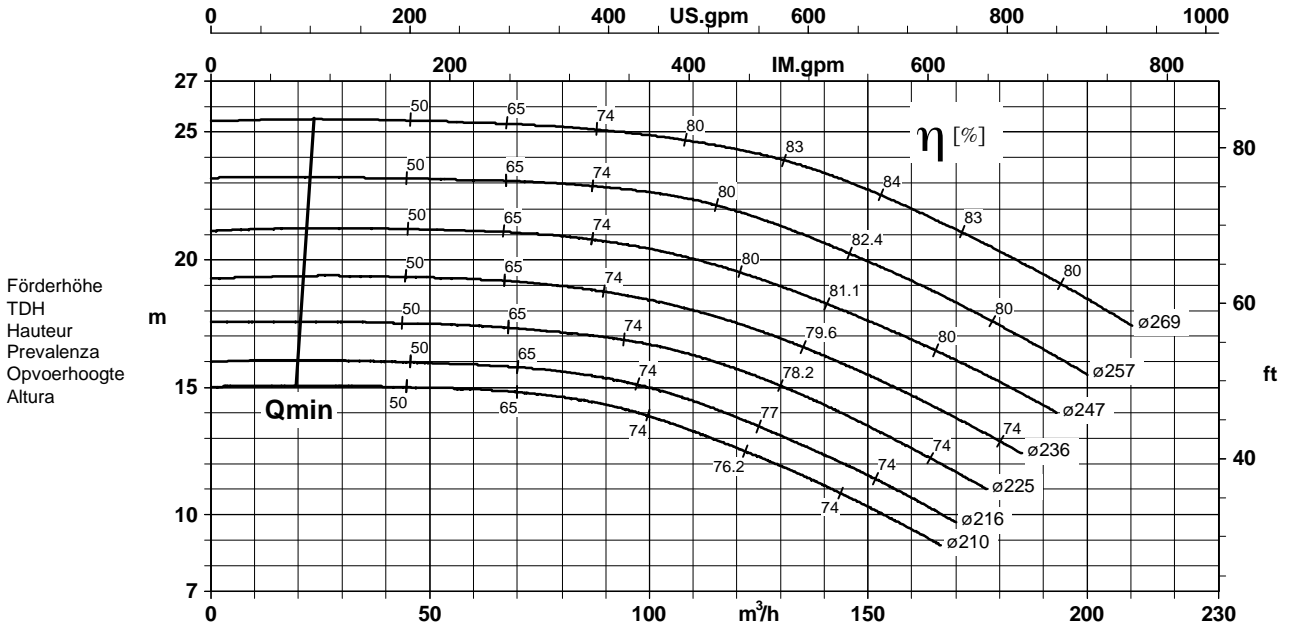

Förderstrom/Flow/Débit/Portata/Kapazität/Caudal K1211.454/394/5

Lauf rad austrittsbreite/Impeller outlet width/Largeur à la sortie de la roue 27,0 mm
 Luce della girante/Waaier uittredbreedte/Anchura de salida rodete 27,0 mm

Baureihe-Größe Type-Size Modèle	Tipo Serie Tipo	Nennzahl Nom. speed Vitesse nom.	Velocità di rotazione nom. Nominaal toerental Revoluciones nom.	Lauf-rad-Ø Impeller Dia. Diamètre de roue	Ø Girante Ø Waaier Ø Rodete	 KSB Aktiengesellschaft Unternehmensbereich Pumpen Industrie- und Wassertechnik Postfach 1725, 67225 Frankenthal Joh.-Klein-Str. 9, 67227 Frankenthal
Etanorm 100-315 Etabloc		1450 1/min				
Projekt Project Projet	Progetto Projekt Proyecto	Angebots-Nr. Project No. No. de l'offre	Offerta-No. Offertenr. Offerta-No.	Pos.-Nr. Item No. No. de pos.	Pos.-Nr. Positiennr. Pos.-Nr.	

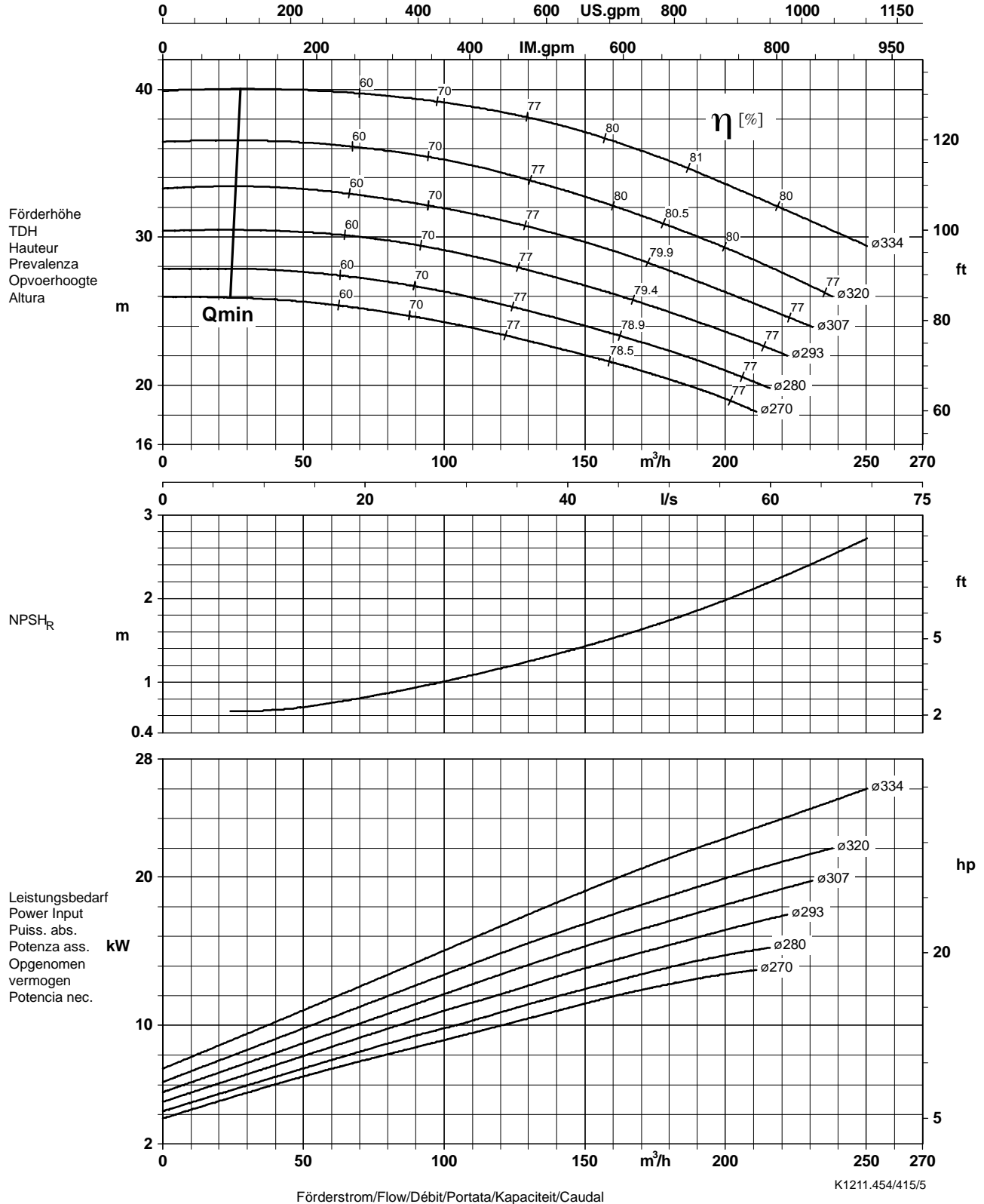

Lauftradaustrittsbreite/Impeller outlet width/Largeur à la sortie de la roue 23,0 mm
 Luce della girante/Waaier uitredbreedte/Anchura de salida rodete 23,0 mm

Baureihe-Größe Type-Size Modèle	Tipo Serie Tipo	Neendrehzahl Nom. speed Vitesse nom.	Velocità di rotazione nom. Nominaal toerental Revoluciones nom.	Laufrad-ø Impeller Dia. Diamètre de roue	ø Girante ø Waaier ø Rodete	 KSB Aktiengesellschaft Unternehmensbereich Pumpen Industrie- und Wassertechnik Postfach 1725, 67225 Frankenthal Joh.-Klein-Str. 9, 67227 Frankenthal
Etanorm 100-400 Etabloc		1450 1/min				
Projekt Project Projet	Progetto Projekt Proyecto	Angebots-Nr. Project No. No. de l'offre	Offerta-No. Offertenr. Offerta-No.	Pos.-Nr. Item No. No. de pos.	Pos.-Nr. Positiën. Pos.-Nr.	

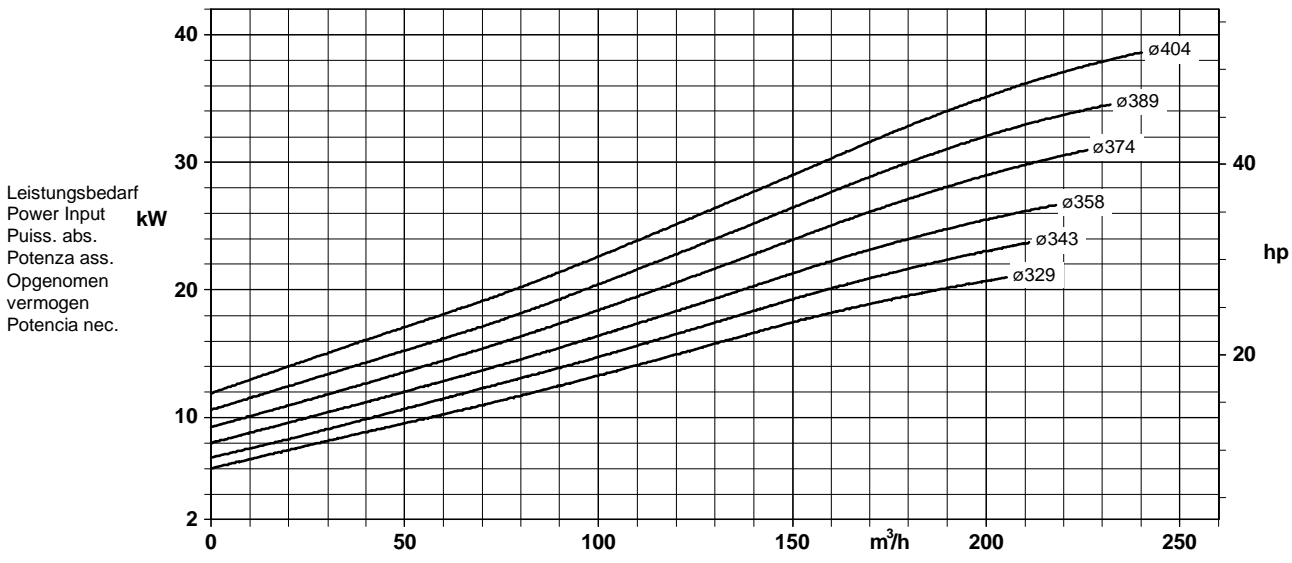
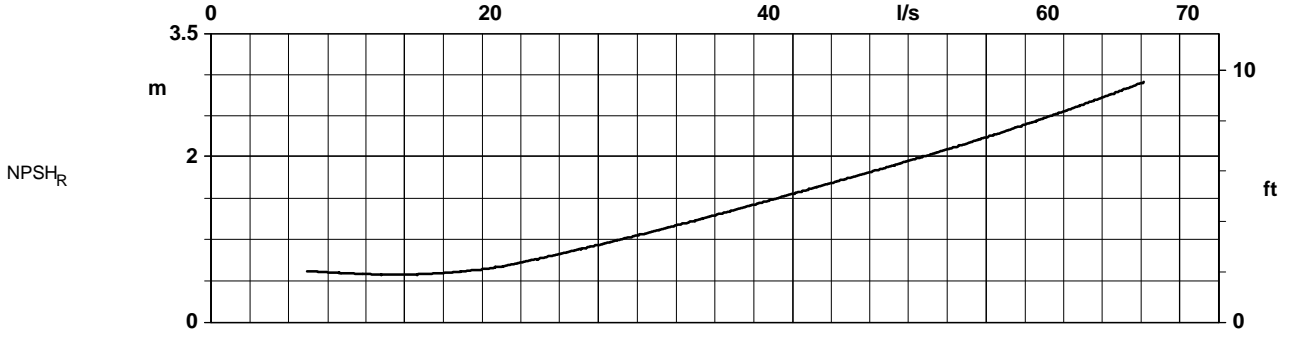
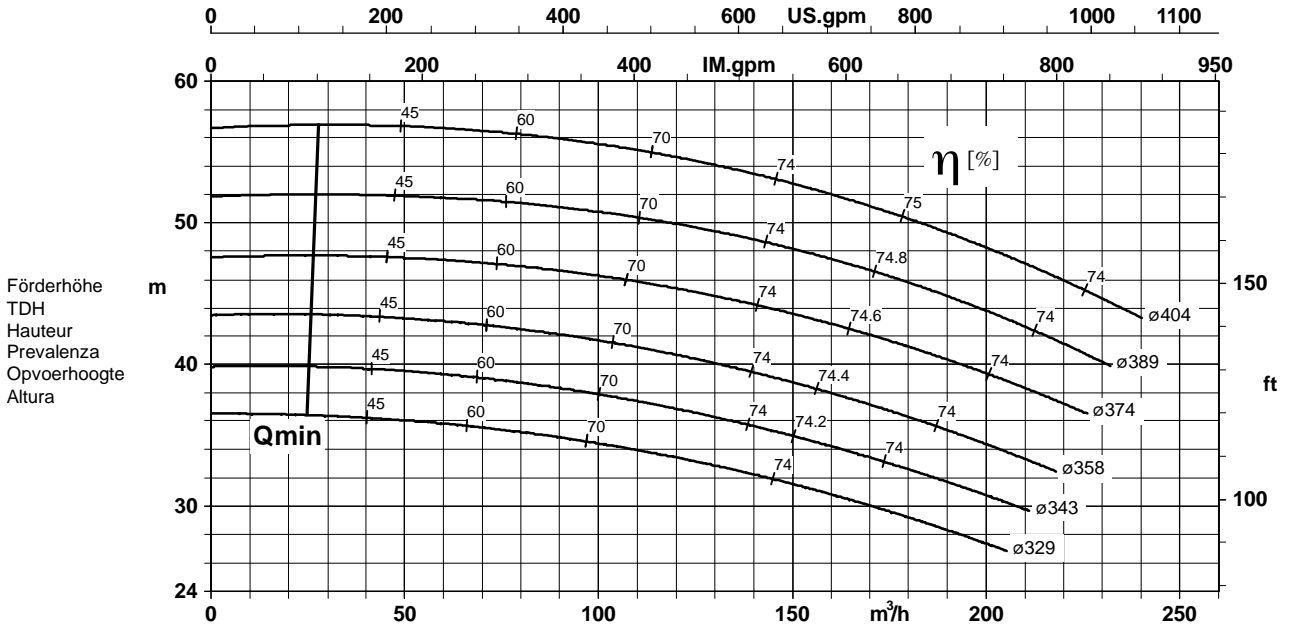

Förderstrom/Flow/Débit/Portata/Kapaciteit/Caudal

Laufradaustrittsbreite/Impeller outlet width/Largeur à la sortie de la roue 17,0 mm
 Luce della girante/Waaier uittredebreedte/Anchura de salida rodete 17,0 mm

K1211.454/416/5

Baureihe-Größe Type-Size Modèle	Tipo Serie Tipo	Nennzahl Nom. speed Vitesse nom.	Velocità di rotazione nom. Nominaal toerental Revoluciones nom.	Laufgrad-Ø Impeller Dia. Diamètre de roue	Ø Girante Ø Waaier Ø Rodete	 KSB Aktiengesellschaft Unternehmensbereich Pumpen Industrie- und Wassertechnik Postfach 1725, 67225 Frankenthal Joh.-Klein-Str. 9, 67227 Frankenthal
Etanorm 125-200 Etabloc		1450 1/min				
Projekt Project Projet	Progetto Projekt Proyecto	Angebots-Nr. Project No. No. de l'offre	Offerta-No. Offertenr. Offerta-No.	Pos.-Nr. Item No. No. de pos.	Pos.-Nr. Positiennr. Pos.-Nr.	

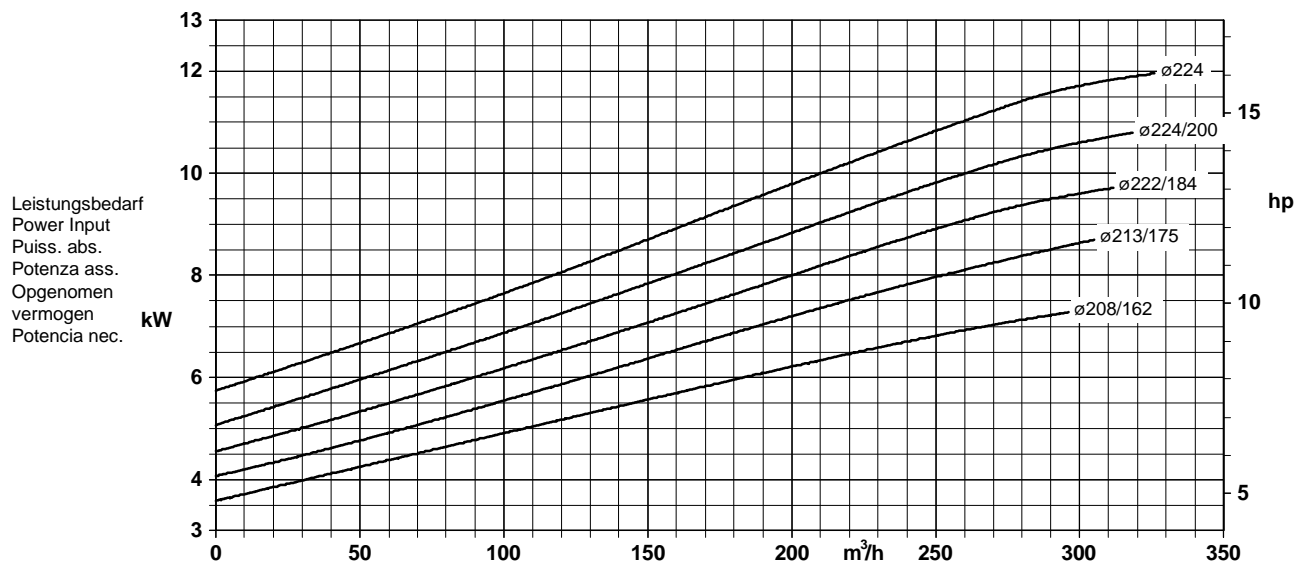
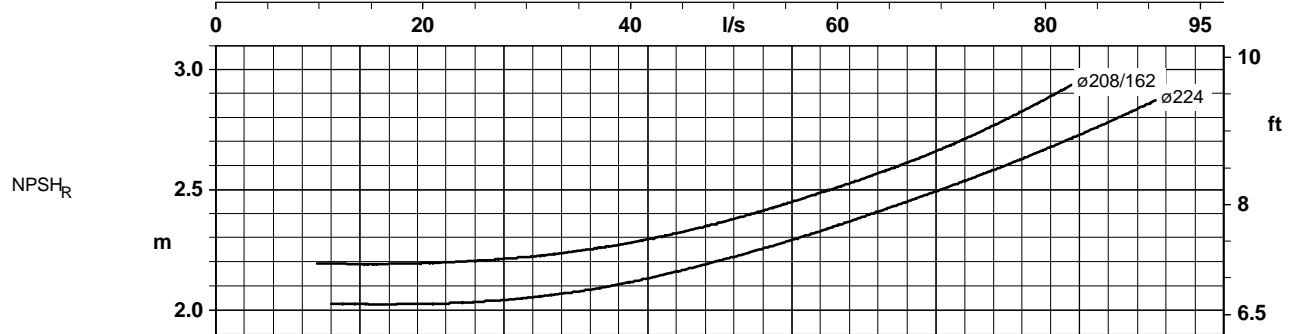
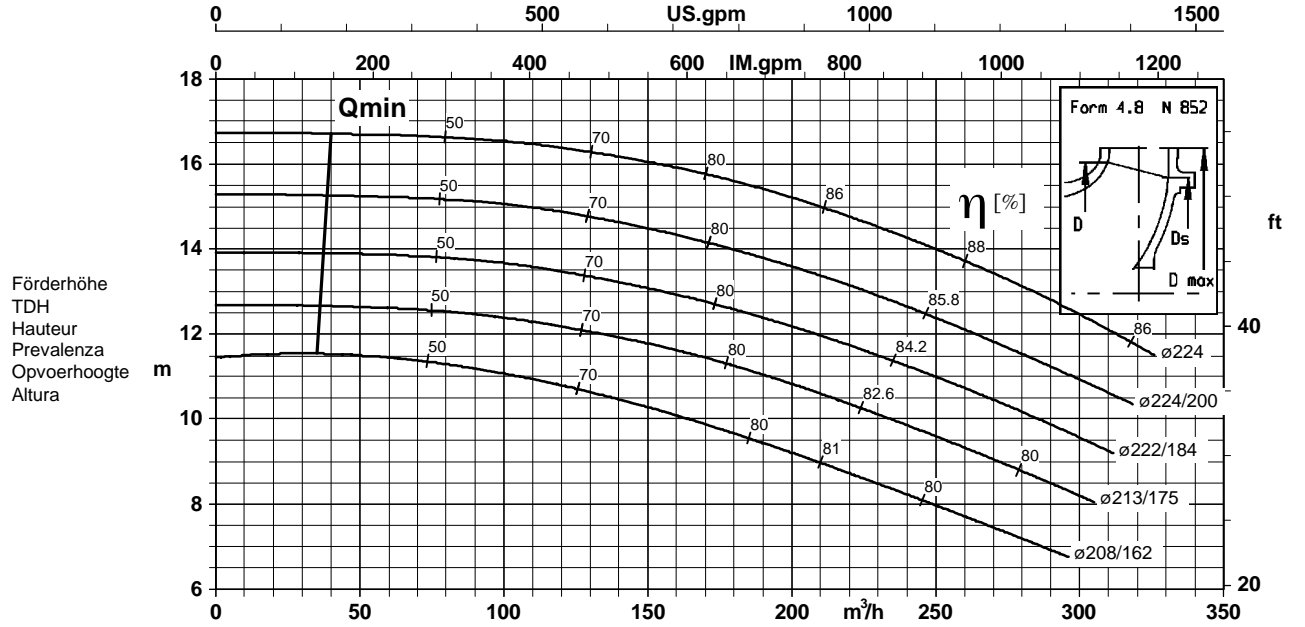

Förderstrom/Flow/Débit/Portata/Kapazität/Caudal

K1211.454/443/5

Lauftradaustrittsbreite/Impeller outlet width/Largeur à la sortie de la roue 40,7 mm
 Luce della girante/Waaier uittebreedte/Anchura de salida rodete 40,7 mm

Baureihe-Größe Type-Size Modèle	Tipo Serie Tipo	Nenn Drehzahl Nom. speed Vitesse nom.	Velocità di rotazione nom. Nominaal toerental Revoluciones nom.	Lauf rad- \varnothing Impeller Dia. Diamètre de roue	\varnothing Girante \varnothing Waaier \varnothing Rodete	 KSB Aktiengesellschaft Unternehmensbereich Pumpen Industrie- und Wassertechnik Postfach 1725, 67225 Frankenthal Joh.-Klein-Str. 9, 67227 Frankenthal
Etanorm 125-250 Etabloc		1450 1/min				
Projekt Project Projet	Progetto Projekt Proyecto	Angebots-Nr. Project No. No. de l'offre	Offerta-No. Offertenr. Offerta-No.	Pos.-Nr. Item No. No. de pos.	Pos.-Nr. Positiën. Pos.-Nr.	

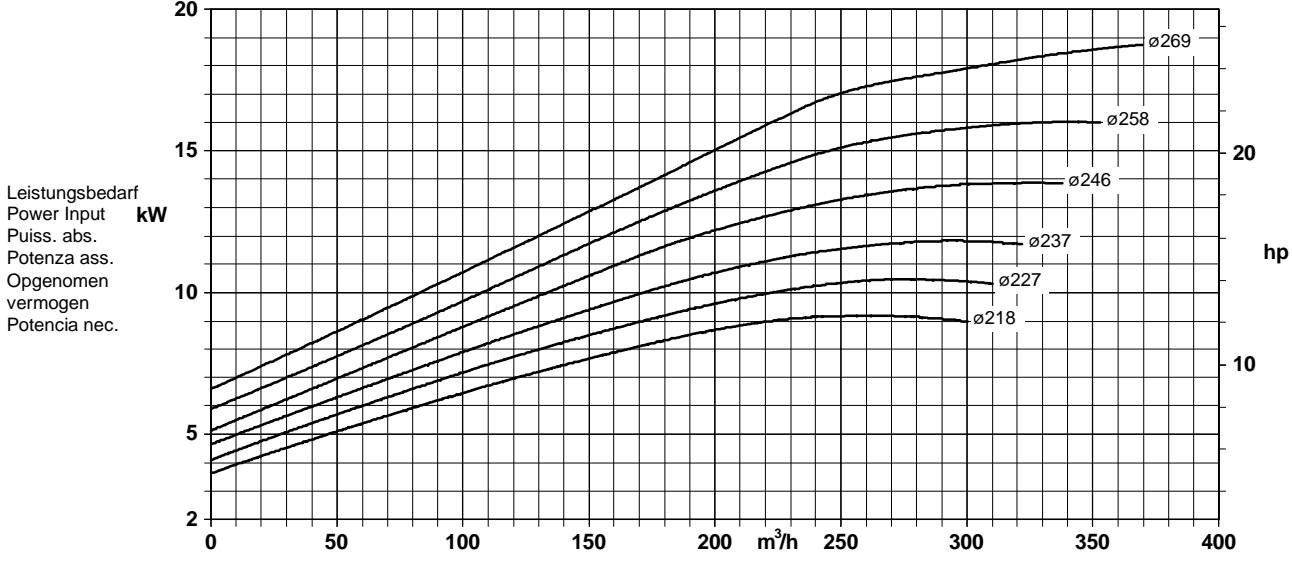
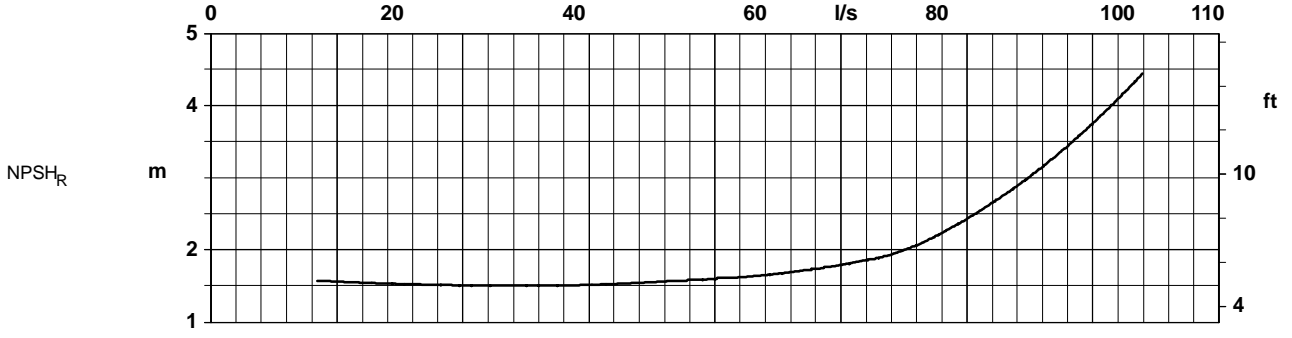
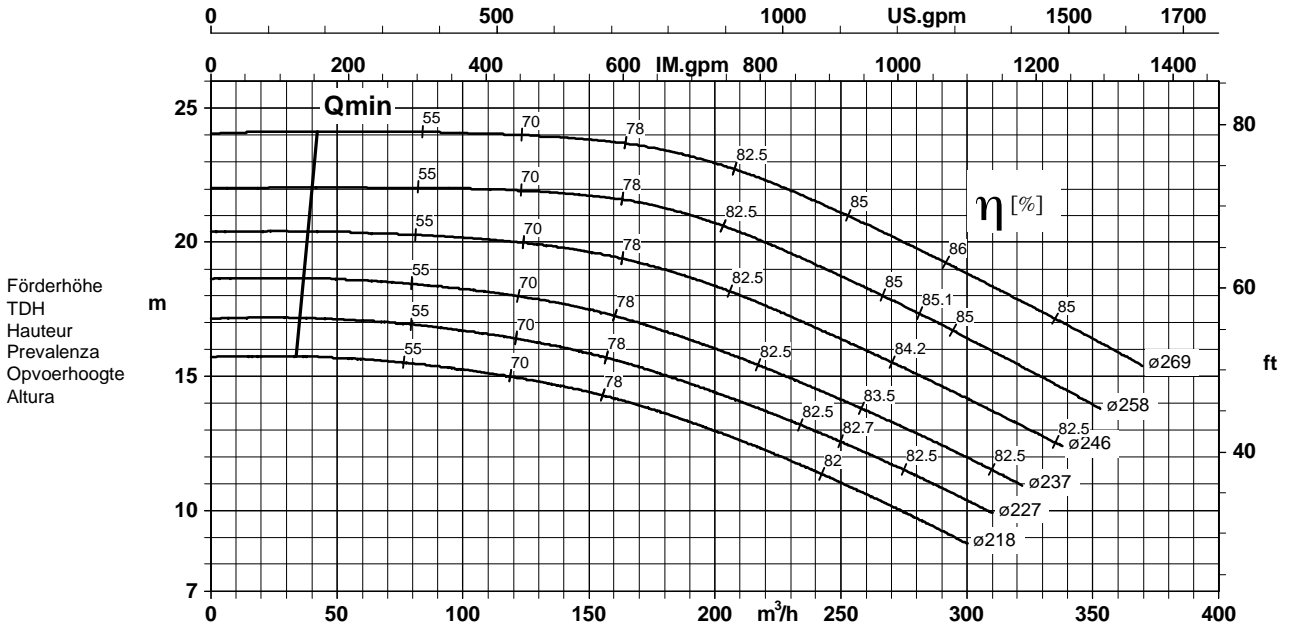

Förderstrom/Flow/Débit/Portata/Kapaciteit/Caudal

K1211.454/444/6

Laufradaustrittsbreite/Impeller outlet width/Largeur à la sortie de la roue 37,0 mm
 Luce della girante/Waaier uittredebreedte/Anchura de salida rodete 37,0 mm

Baureihe-Größe Type-Size Modèle	Tipo Serie Tipo	Nennzahl Nom. speed Vitesse nom.	Velocità di rotazione nom. Nominaal toerental Revoluciones nom.	Laufrad-Ø Impeller Dia. Diamètre de roue	Ø Girante Ø Waaier Ø Rodete	 KSB Aktiengesellschaft Unternehmensbereich Pumpen Industrie- und Wassertechnik Postfach 1725, 67225 Frankenthal Joh.-Klein-Str. 9, 67227 Frankenthal
Etanorm 125-315 Etabloc		1450 1/min				
Projekt Project Projet	Progetto Projekt Proyecto	Angebots-Nr. Project No. No. de l'offre	Offerta-No. Offertenr. Offerta-No.	Pos.-Nr. Item No. No. de pos.	Pos.-Nr. Positiennr. Pos.-Nr.	

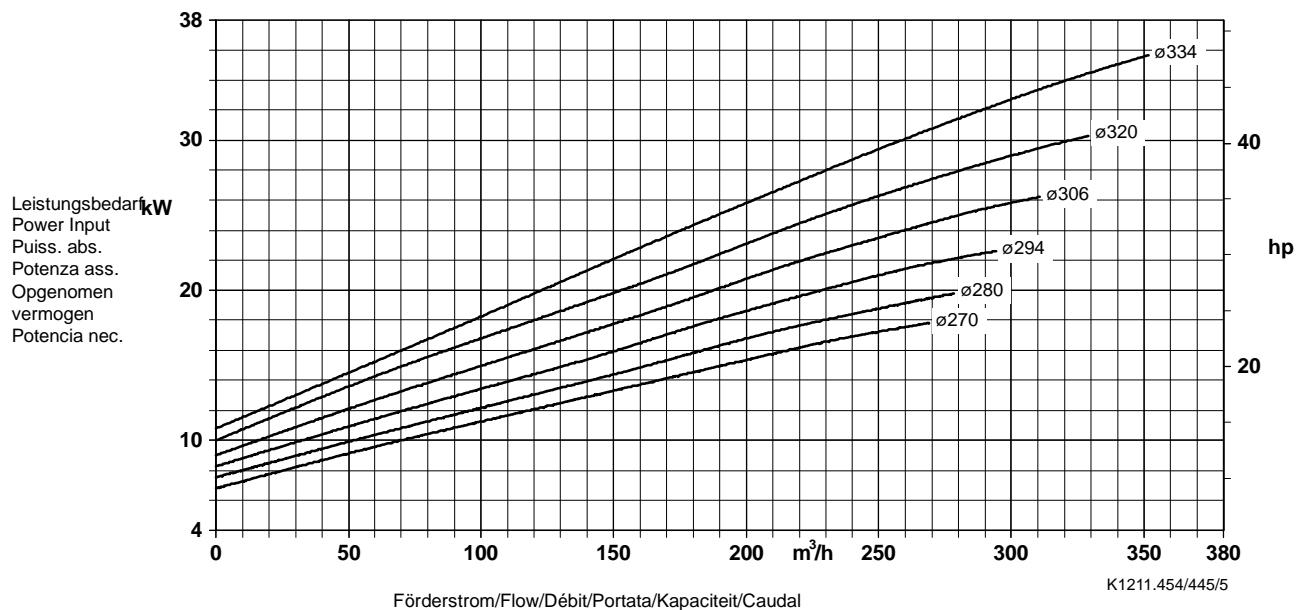
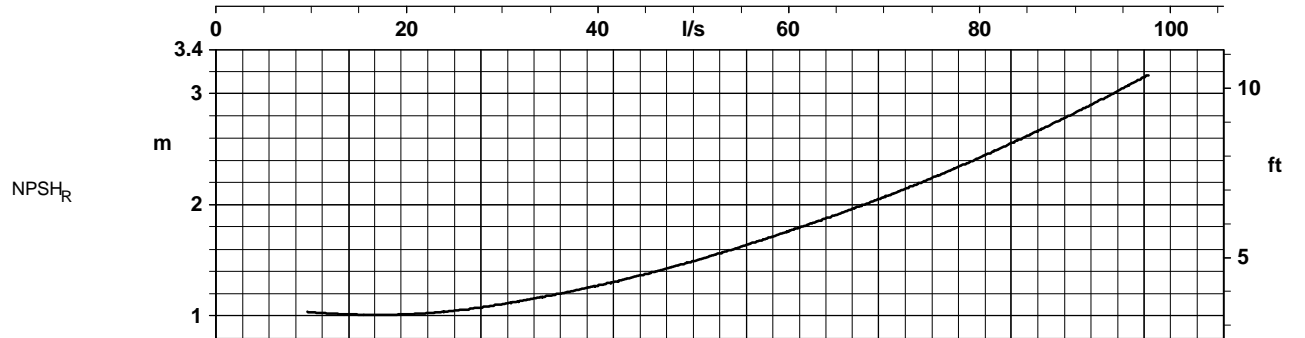
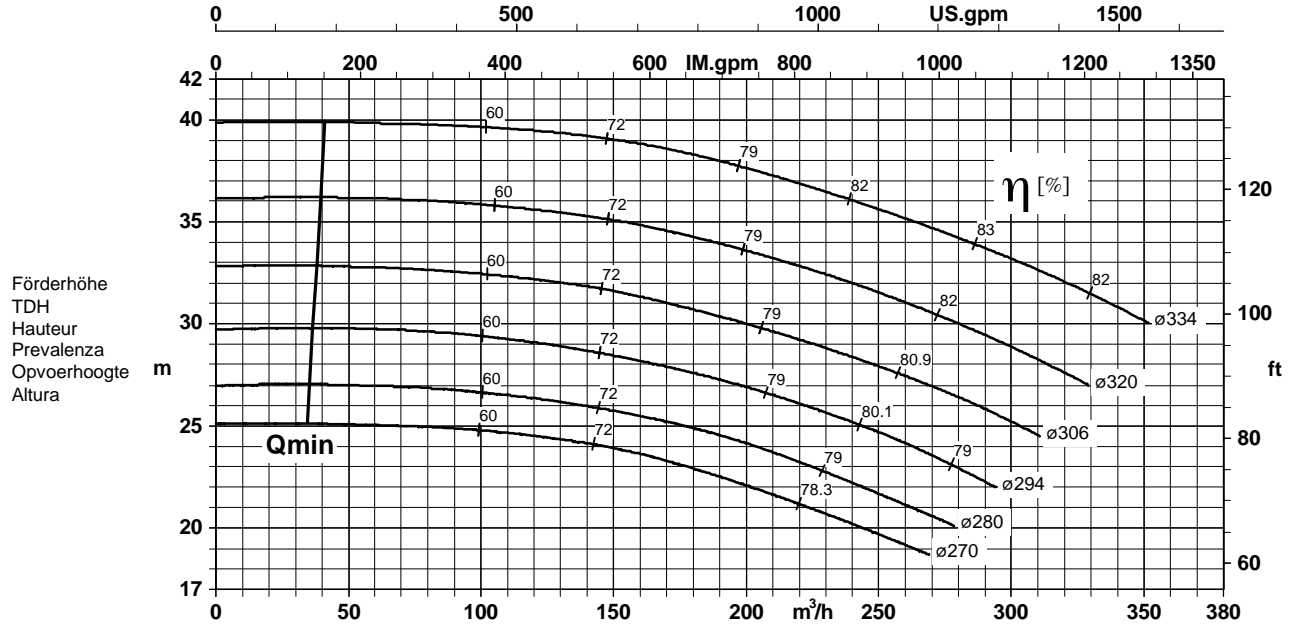

Laufradaustrittsbreite/Impeller outlet width/Largeur à la sortie de la roue 30,9 mm
 Luce della girante/Waaier uitredbreedte/Anchura de salida rodete 30,9 mm

Baureihe-Größe Type-Size Modèle	Tipo Serie Tipo	Neendrehzahl Nom. speed Vitesse nom.	Velocità di rotazione nom. Nominaal toerental Revoluciones nom.	Laufrad- ϕ Impeller Dia. Diamètre de roue	ϕ Girante ϕ Waaier ϕ Rodete	 KSB Aktiengesellschaft Unternehmensbereich Pumpen Industrie- und Wassertechnik Postfach 1725, 67225 Frankenthal Joh.-Klein-Str. 9, 67227 Frankenthal
Etanorm 125-400 Etabloc		1450 1/min				
Projekt Project Projet	Progetto Projekt Proyecto	Angebots-Nr. Project No. No. de l'offre	Offerta-No. Offertenr. Offerta-No.	Pos.-Nr. Item No. No. de pos.	Pos.-Nr. Positiën. Pos.-Nr.	

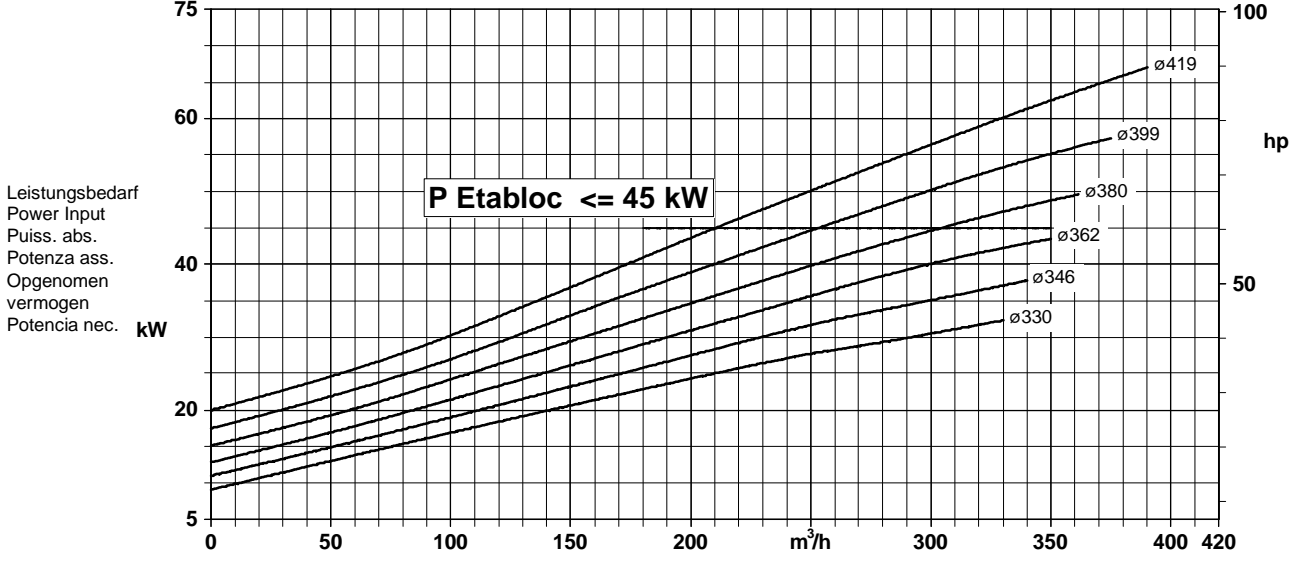
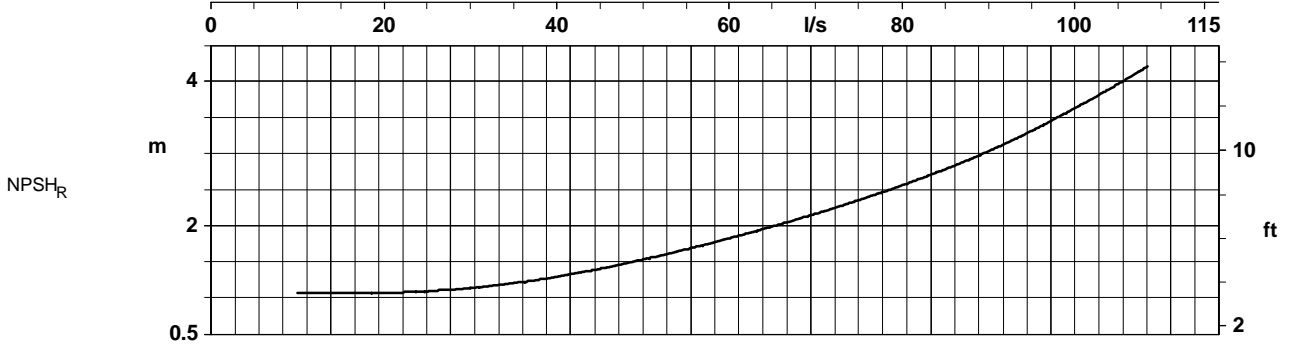
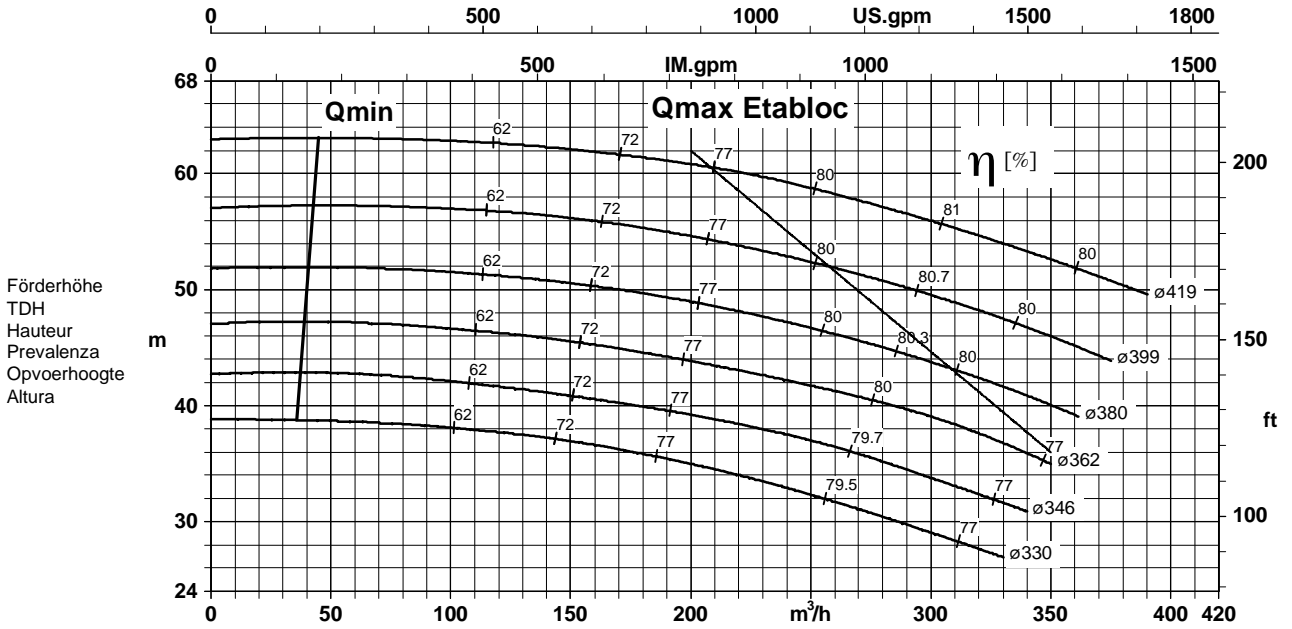

Förderstrom/Flow/Débit/Portata/Kapaciteit/Caudal

K1211.454/457/5

Laufradaustrittsbreite/Impeller outlet width/Largeur à la sortie de la roue 25,9 mm
 Luce della girante/Waaier uittredebreedte/Anchura de salida rodete 25,9 mm

Baureihe-Größe Type-Size Modèle	Tipo Serie Tipo	Nenn Drehzahl Nom. speed Vitesse nom.	Velocità di rotazione nom. Nominaal toerental Revoluciones nom.	Lauf rad-ø Impeller Dia. Diamètre de roue	ø Girante ø Waaier ø Rodete	 KSB Aktiengesellschaft Unternehmensbereich Pumpen Industrie- und Wassertechnik Postfach 1725, 67225 Frankenthal Joh.-Klein-Str. 9, 67227 Frankenthal
Etanorm 150-200 Etabloc		1450 1/min				
Projekt Project Projet	Progetto Projekt Proyecto	Angebots-Nr. Project No. No. de l'offre	Offerta-No. Offertenr. Offerta-No.	Pos.-Nr. Item No. No. de pos.	Pos.-Nr. Positiën. Pos.-Nr.	

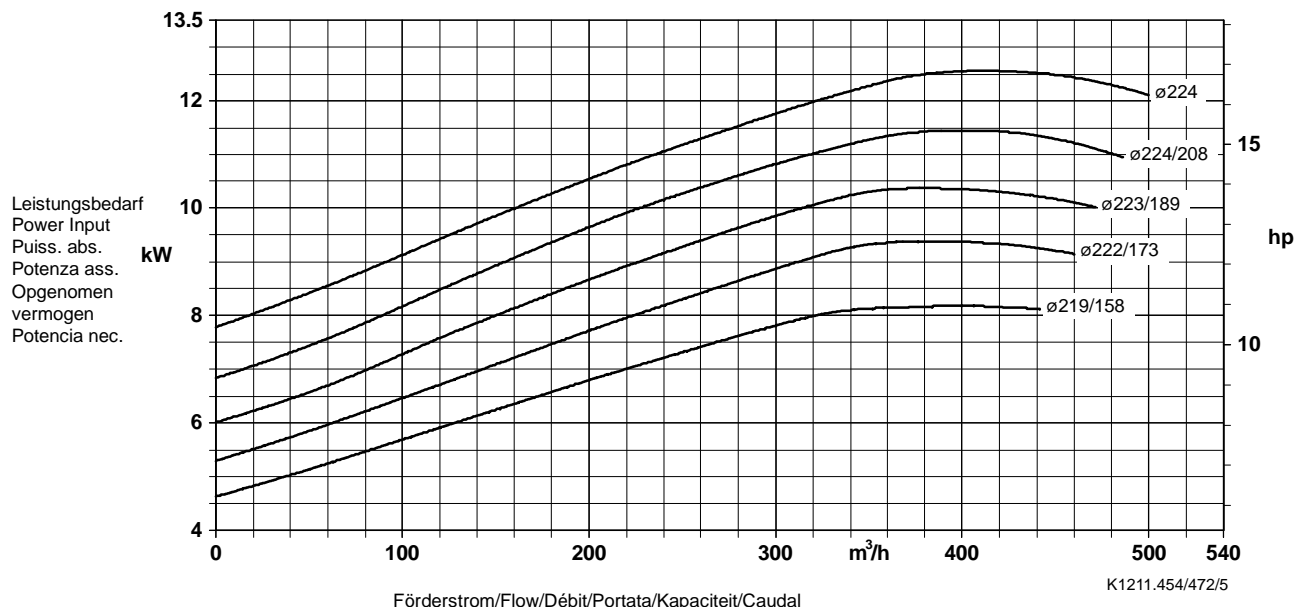
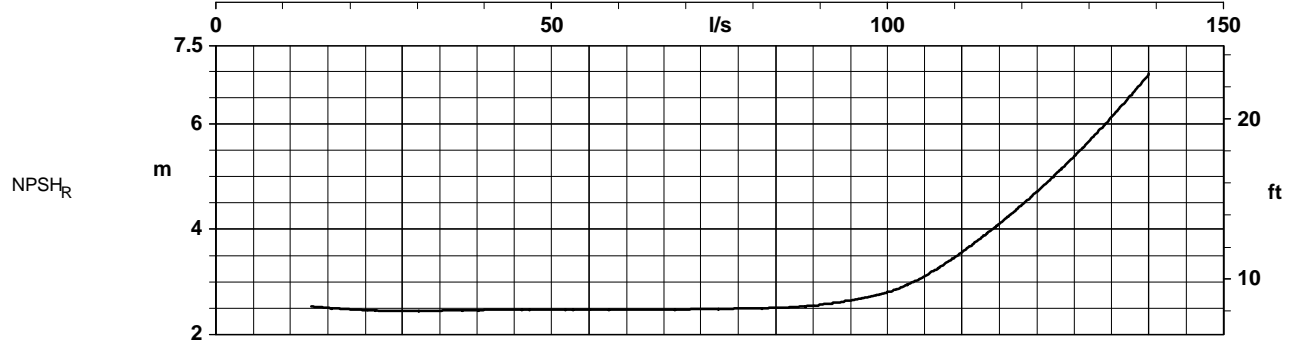
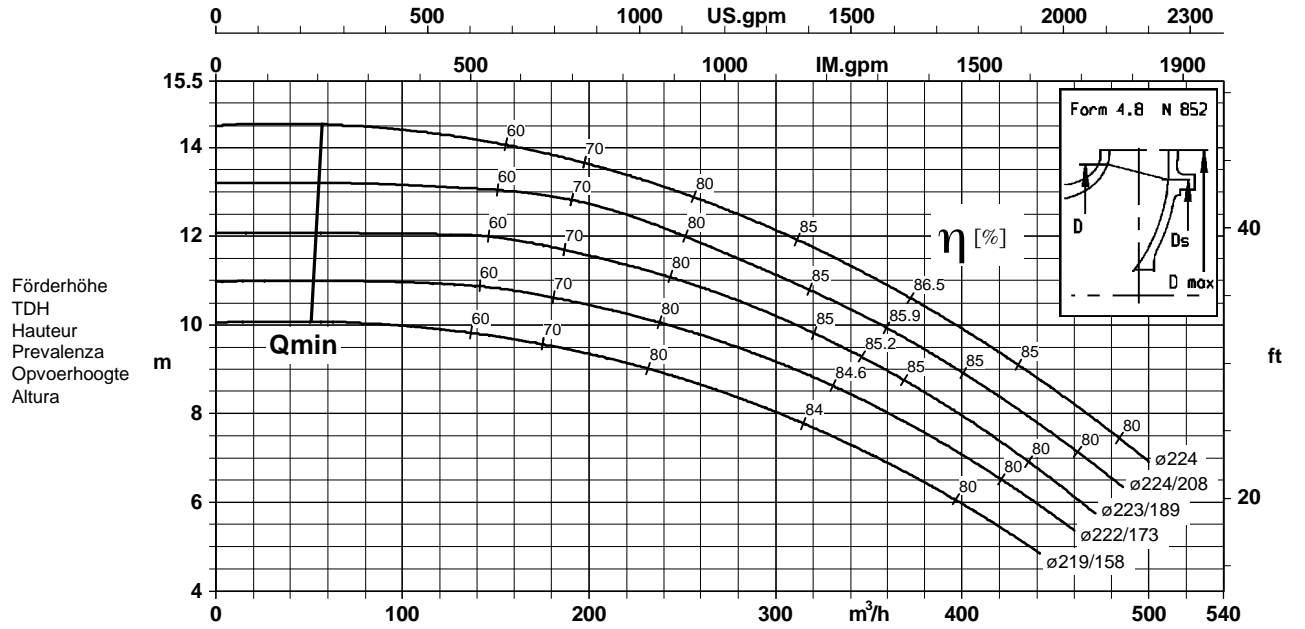

Lauf rad austrittsbreite / Impeller outlet width / Largeur à la sortie de la roue 59,5 mm
 Luce della girante / Waaier uitred breedte / Anchura de salida rodete 59,5 mm

K1211.454/472/5

Baureihe-Größe Type-Size Modèle	Tipo Serie Tipo	Nenn Drehzahl Nom. speed Vitesse nom.	Velocità di rotazione nom. Nominaal toerental Revoluciones nom.	Lauf rad- ϕ Impeller Dia. Diamètre de roue	ϕ Girante ϕ Waaier ϕ Rodete	 KSB Aktiengesellschaft Unternehmensbereich Pumpen Industrie- und Wassertechnik Postfach 1725, 67225 Frankenthal Joh.-Klein-Str. 9, 67227 Frankenthal
Etanorm 150-250 Etabloc		1450 1/min				
Projekt Project Projet	Progetto Projekt Proyecto	Angebots-Nr. Project No. No. de l'offre	Offerta-No. Offertenr. Offerta-No.	Pos.-Nr. Item No. No. de pos.	Pos.-Nr. Positiën. Pos.-Nr.	

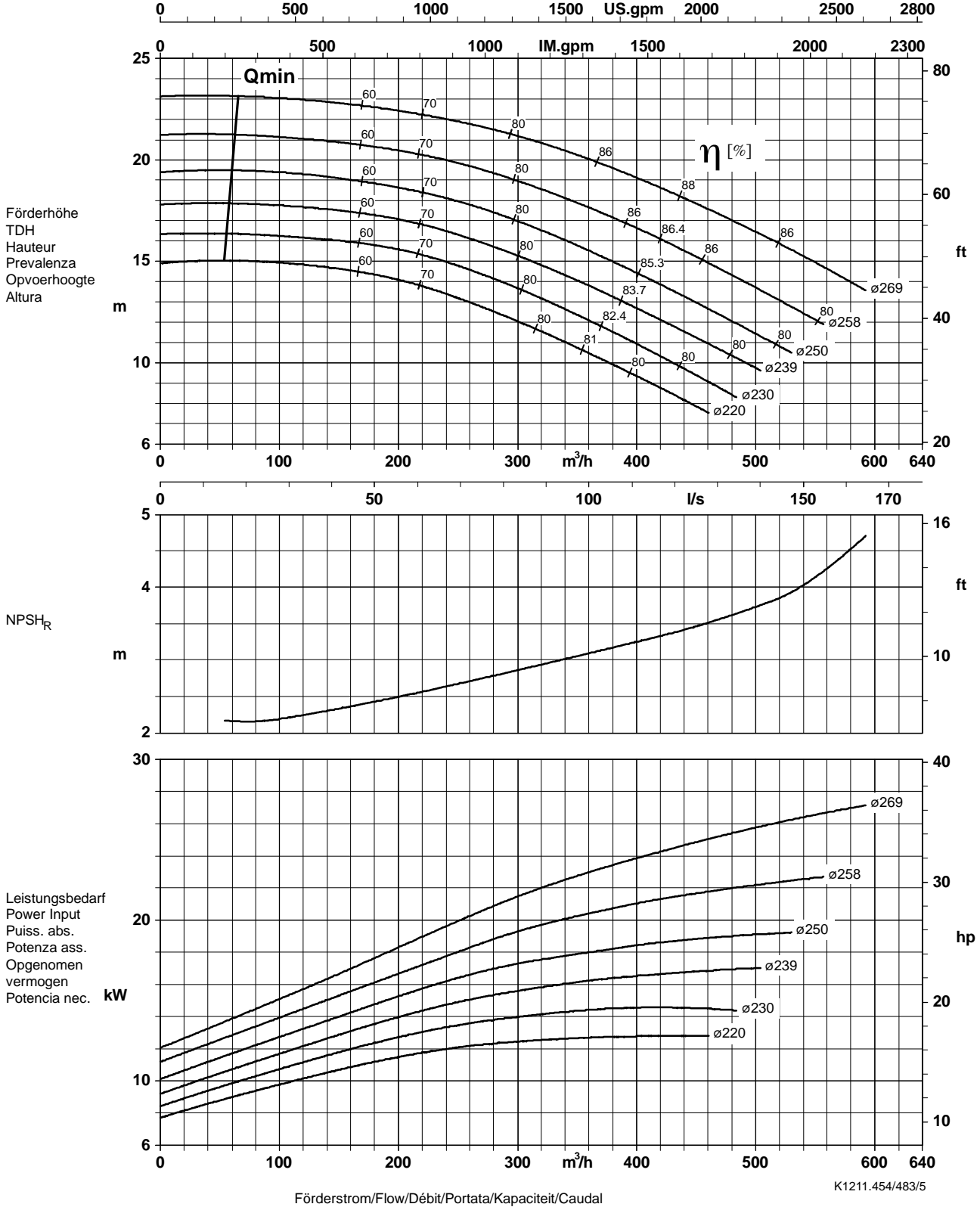

Lauf rad austrittsbreite / Impeller outlet width / Largeur à la sortie de la roue 48,8 mm
 Luce della girante / Waaier uitbreedte / Anchura de salida rodete 48,8 mm

Baureihe-Größe Type-Size Modèle	Tipo Serie Tipo	Nenndrehzahl Nom. speed Vitesse nom.	Velocità di rotazione nom. Nominaal toerental Revoluciones nom.	Laufrad-ø Impeller Dia. Diamètre de roue	ø Girante ø Waaier ø Rodete	 KSB Aktiengesellschaft Unternehmensbereich Pumpen Industrie- und Wassertechnik Postfach 1725, 67225 Frankenthal Joh.-Klein-Str. 9, 67227 Frankenthal
Etanorm 150-315 Etabloc		1450 1/min				
Projekt Project Projet	Progetto Projekt Proyecto	Angebots-Nr. Project No. No. de l'offre	Offerta-No. Offertenr. Offerta-No.	Pos.-Nr. Item No. No. de pos.	Pos.-Nr. Positiennr. Pos.-Nr.	

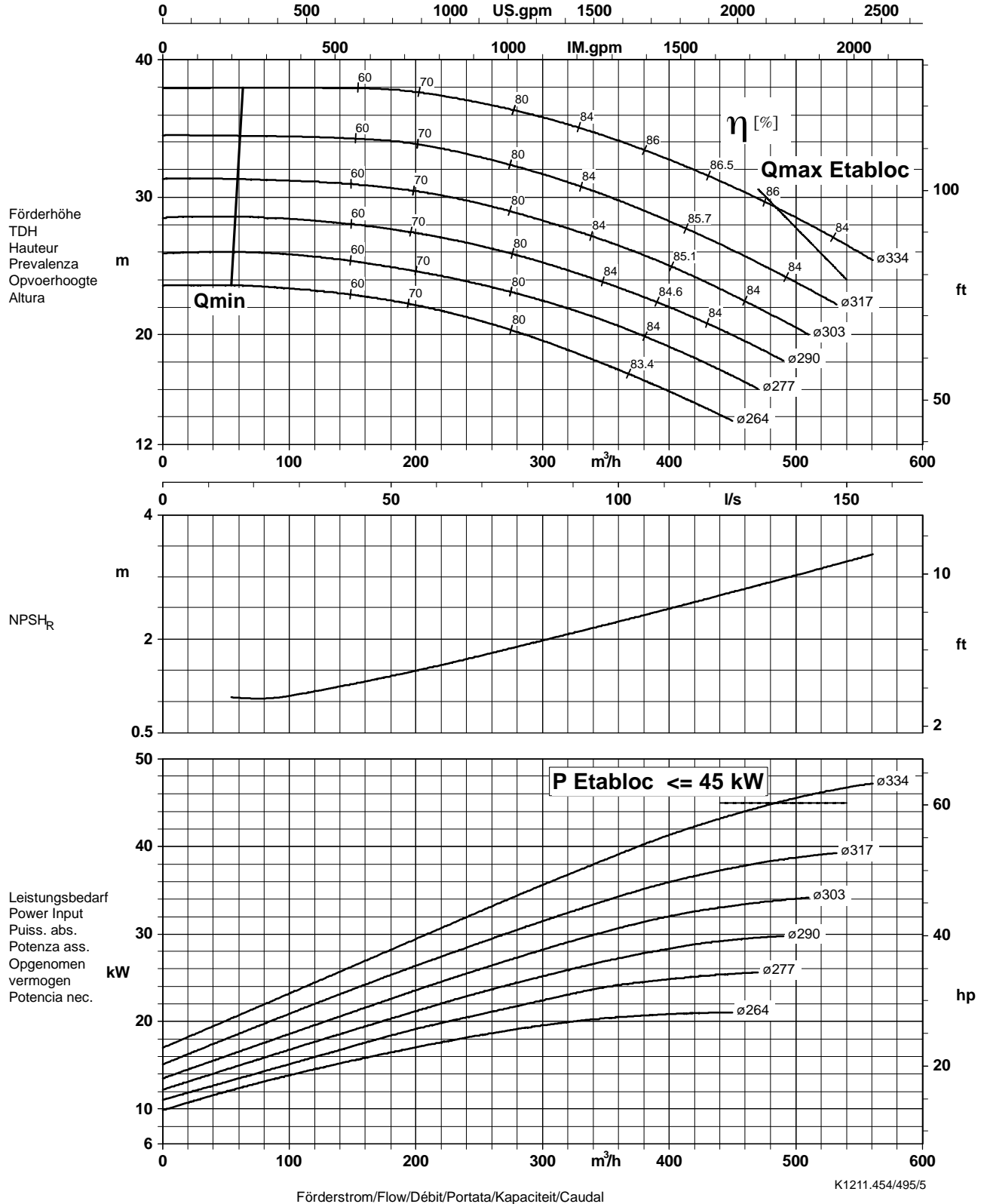

Laufradaustrittsbreite/Impeller outlet width/Largeur à la sortie de la roue 39,7 mm
 Luce della girante/Waaier uitredbreedte/Anchura de salida rodete 39,7 mm

Baureihe-Größe Type-Size Modèle	Tipo Serie Tipo	Neendrehzahl Nom. speed Vitesse nom.	Velocità di rotazione nom. Nominaal toerental Revoluciones nom.	Laufrad-ø Impeller Dia. Diamètre de roue	ø Girante ø Waaier ø Rodete	 KSB Aktiengesellschaft Unternehmensbereich Pumpen Industrie- und Wassertechnik Postfach 1725, 67225 Frankenthal Joh.-Klein-Str. 9, 67227 Frankenthal
Etanorm 150-400 Etabloc		1450 1/min				
Projekt Project Projet	Progetto Projekt Proyecto	Angebots-Nr. Project No. No. de l'offre	Offerta-No. Offertenr. Offerta-No.	Pos.-Nr. Item No. No. de pos.	Pos.-Nr. Positiën. Pos.-Nr.	

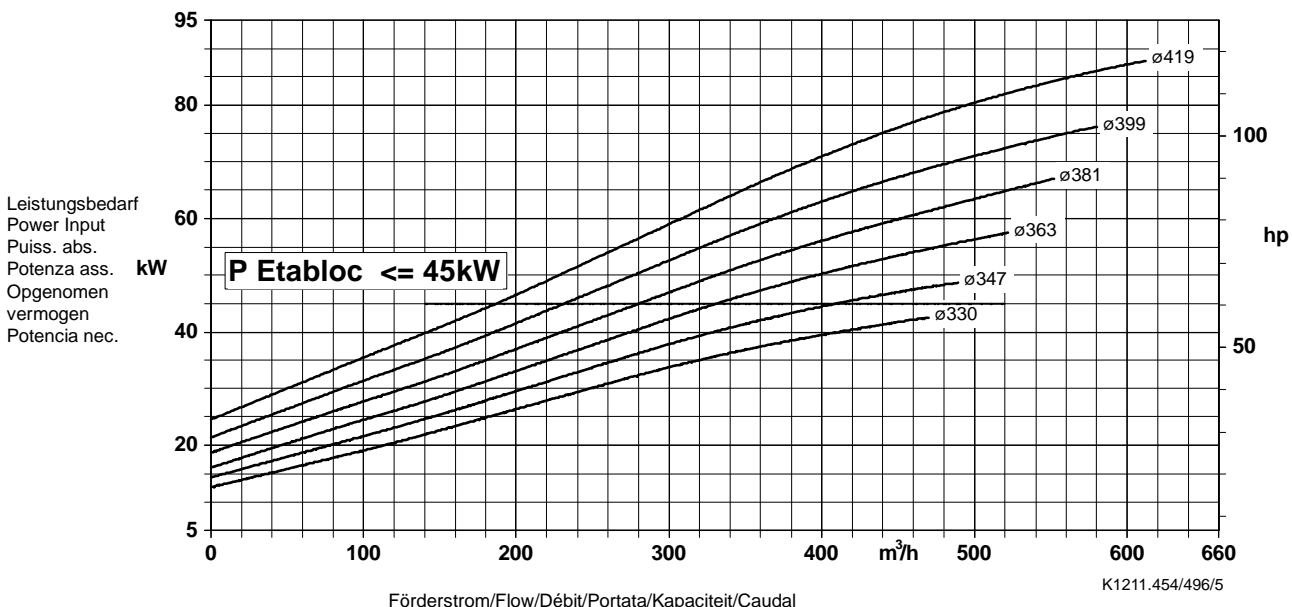
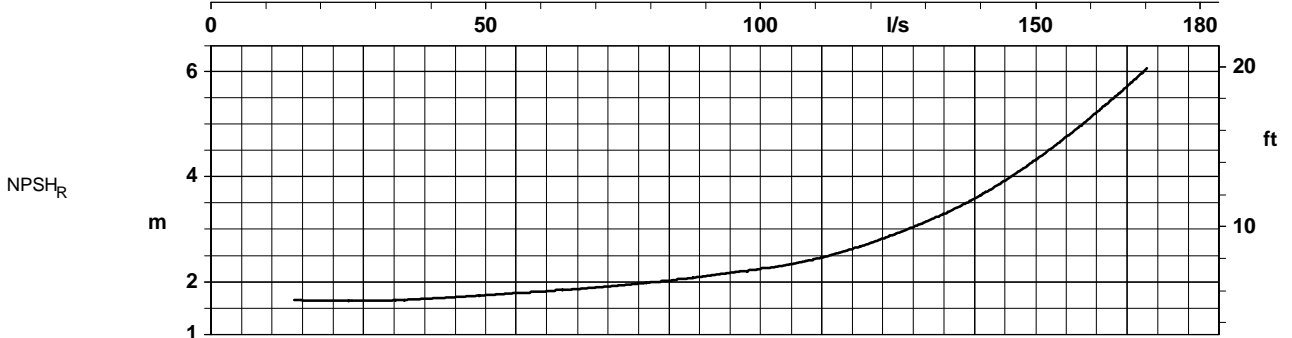
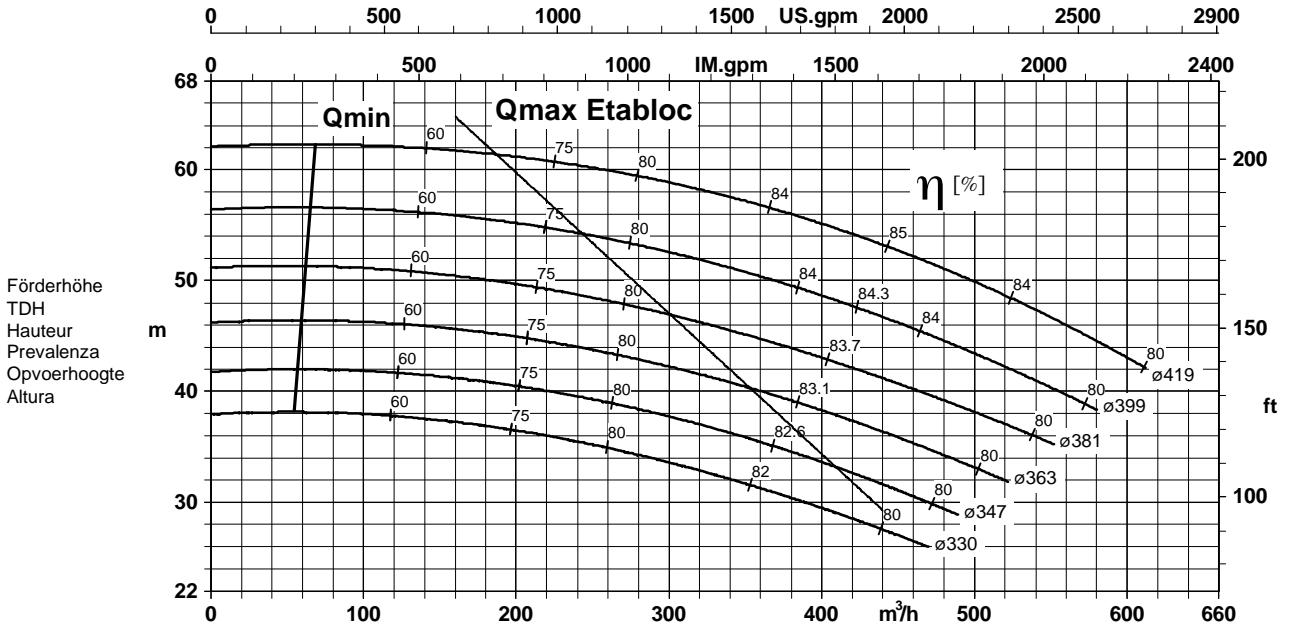

Laufradaustrittsbreite/Impeller outlet width/Largeur à la sortie de la roue 33,0 mm
 Luce della girante/Waaier uittredebreedte/Anchura de salida rodete 33,0 mm

K1211.454/496/5



