



# SKF LAGE

Instructions for use  
Mode d'emploi  
Bedienungsanleitung  
Instrucciones de uso  
Manuale d'istruzioni  
Bruksanvisning

Gebruiksaanwijzing  
Instrucções de utilização  
Brugervejledning  
Käyttöohje  
Οδηγίες χρήσης  
取扱説明書

## EU-DECLARATION OF CONFORMITY

We, SKF Maintenance Products, Kelvinbaan 16, 3439 MT Nieuwegein, The Netherlands, declare that the

### SKF AUTOMATIC LUBRICATOR SYSTEM 24 EML LAGE series

is designed and manufactured in accordance with:

European Machinery Directive 98/37/EC OF THE EUROPEAN  
PARLIAMENT AND OF THE COUNCIL of 22 June 1998 on the

approximation of the laws of the Member States relating to machinery  
and

EMC (Electromagnetic Compatibility) European Directive EMC 89/336/EEC  
and conforms the following harmonised standards:

EN ISO 12100 - 1:2003

EN ISO 12100 - 2:2003

EN 60204 - 1:2007

The Netherlands, 20 September 2007



Sébastien David  
Manager Product Development and Quality

T Code 59°C - Category BAYZ - 92 UM

This lubricant dispensing equipment is suitable for use in Class I, Division 2, Groups A, B, C and D - Class II, Division 2, Group F and G - Class III or non-hazardous locations only



WARNING - EXPLOSION HAZARD - BATTERIES MUST ONLY  
BE CHANGED IN AN AREA TO BE KNOWN TO BE  
NON-HAZARDOUS



WARNING - EXPLOSION HAZARD - SUBSTITUTION OF  
COMPONENTS MAY IMPAIR SUITABILITY FOR CLASS I,  
DIVISION 2



LAGE  
MP5343



TMBA G11D



[www.mapro.skf.com](http://www.mapro.skf.com)



LGFP 2  
LHMT 68  
LHFP 150  
LHHT 265

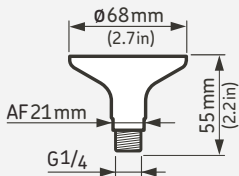
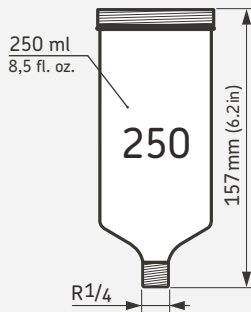
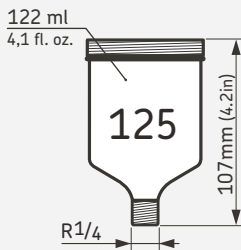
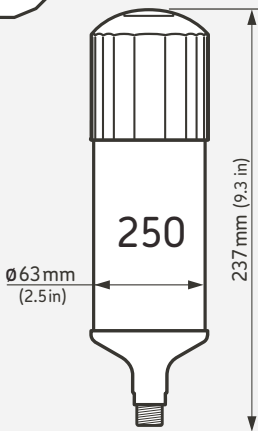
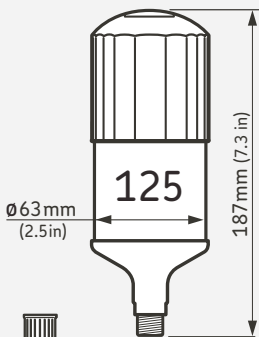
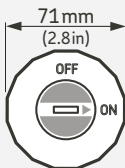

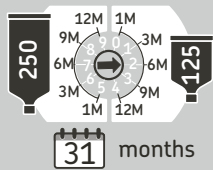
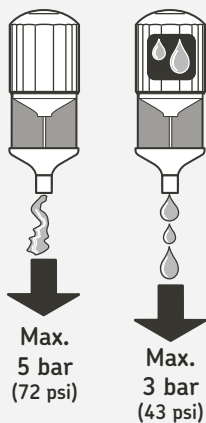
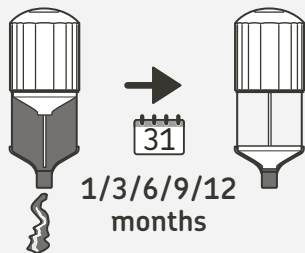
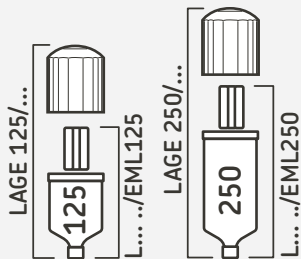

	125	250
	ml/day	ml/day
1M	4,1	8,3
3M	1,4	2,8
6M	0,7	1,4
9M	0,5	0,9
12M	0,3	0,7

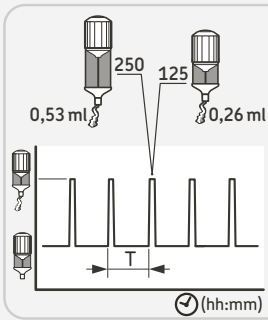

months	T
1M	1:30
3M	4:37
6M	9:17
9M	13:57
12M	18:36



EU Code:  
150110



EU Code:  
160604

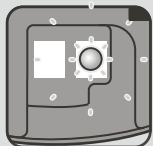

15 s



OK

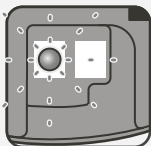

8 s

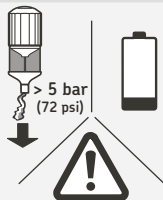

Error Stop

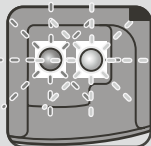

3 s

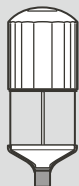

0 ml

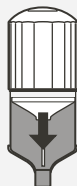
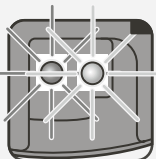

OK

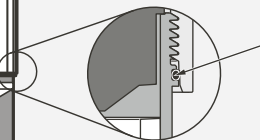
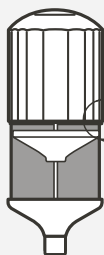

IP65



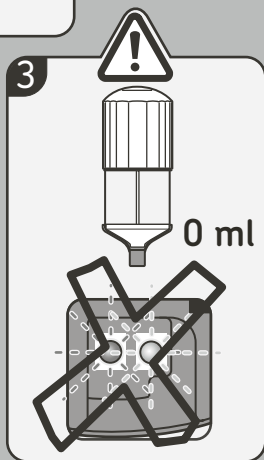
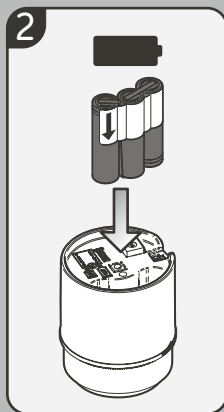
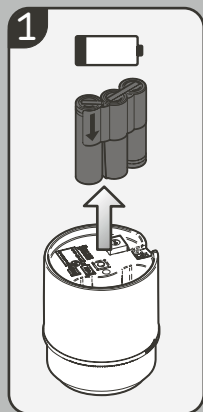
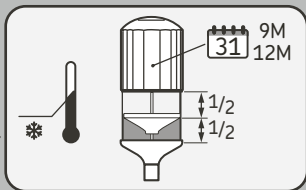
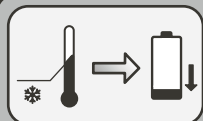
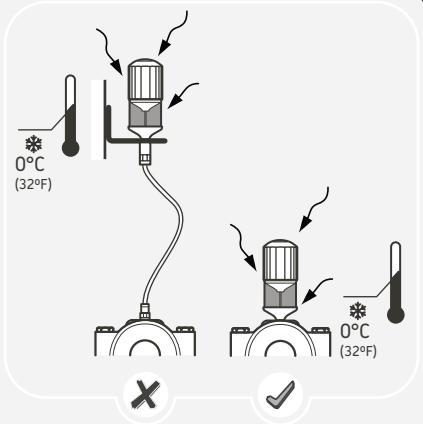
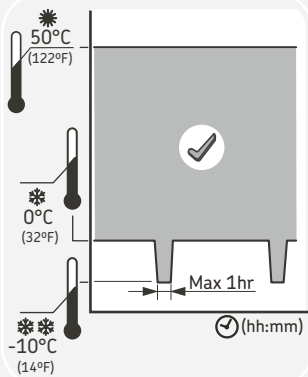

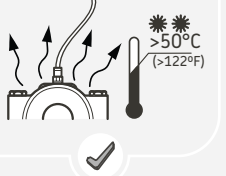
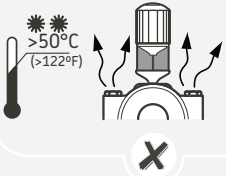
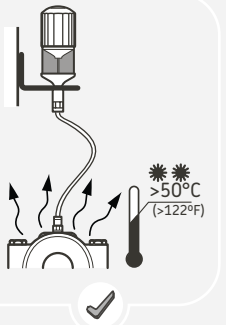
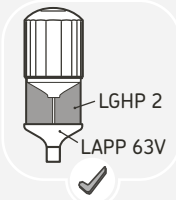
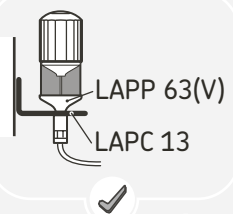
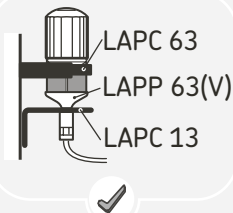
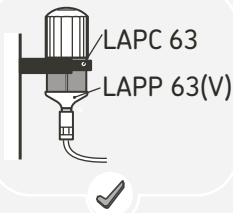



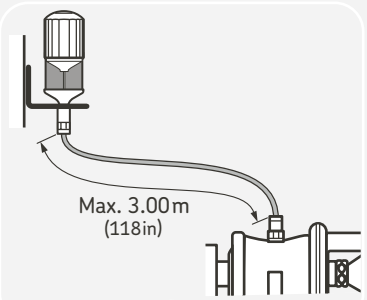
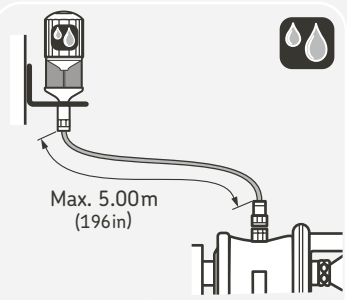
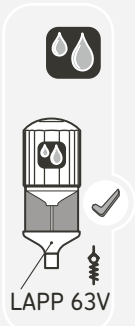
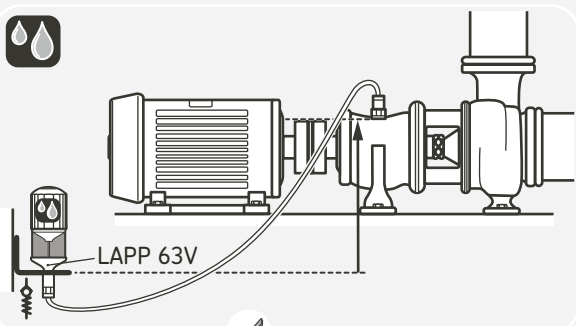
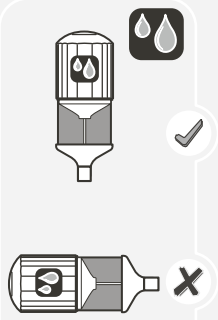
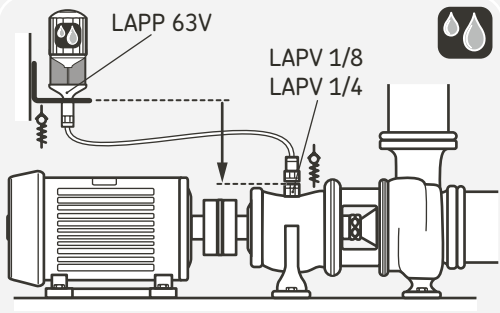

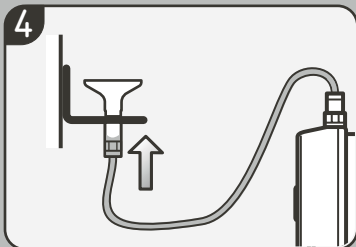
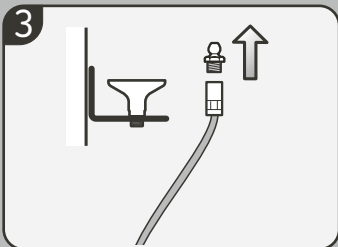
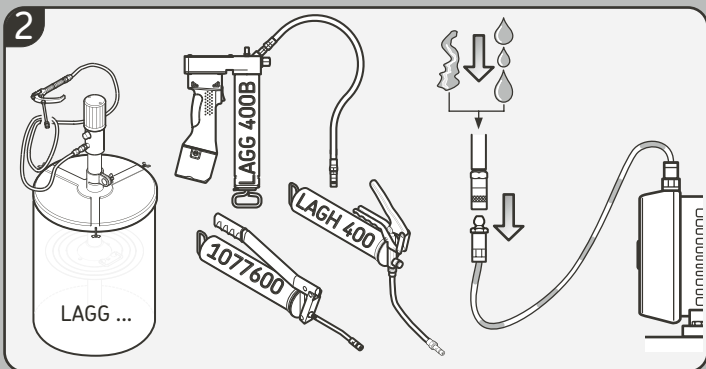
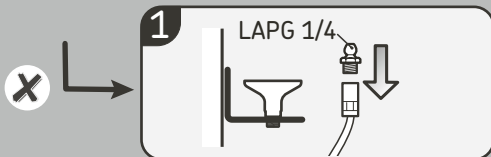
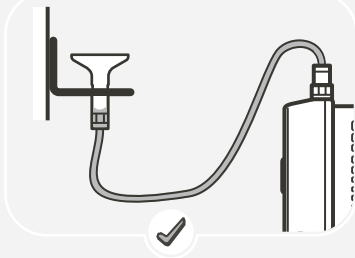
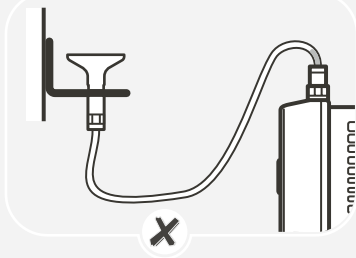

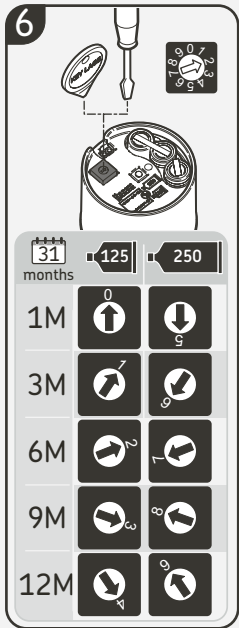
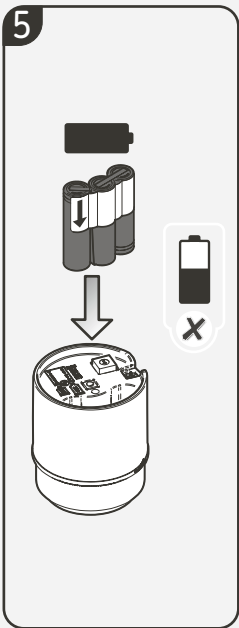
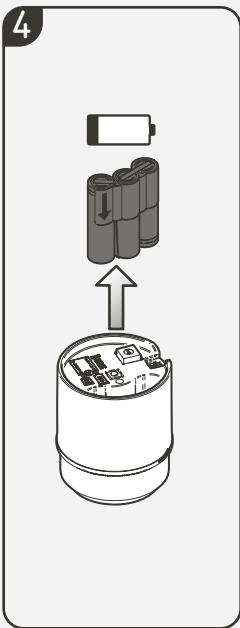
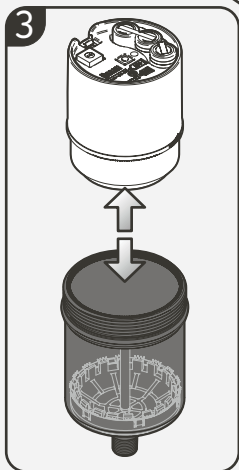
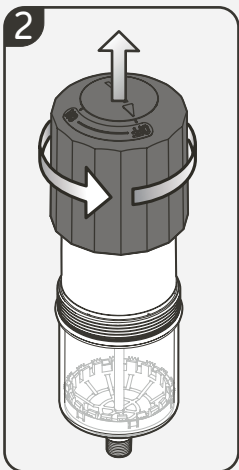
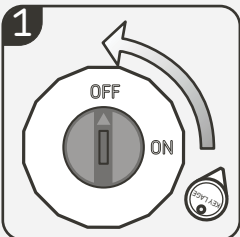
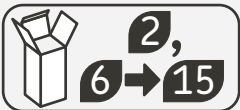

7

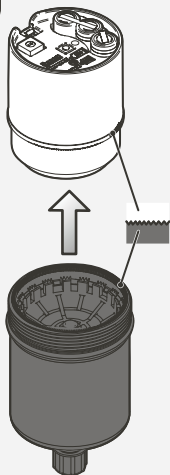

8

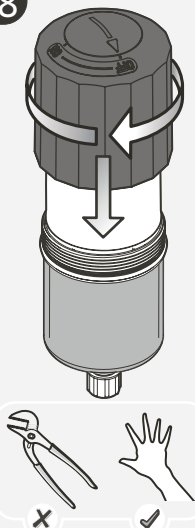

9

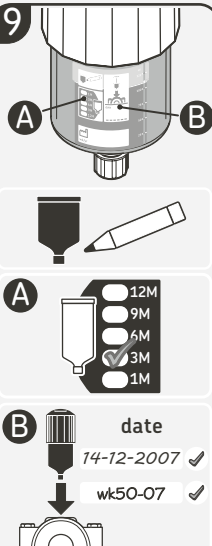

10

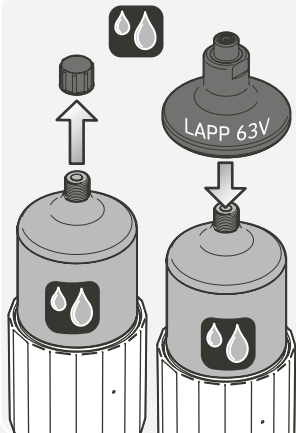
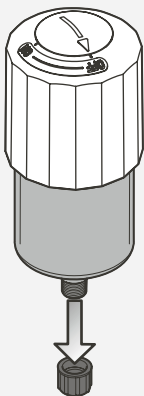

11

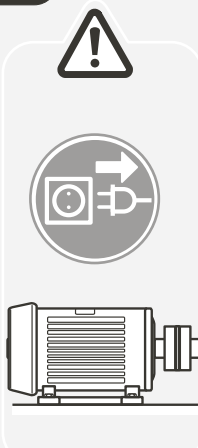

12

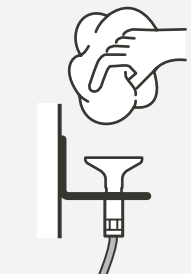
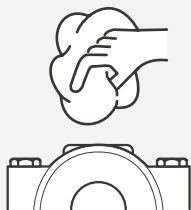

13

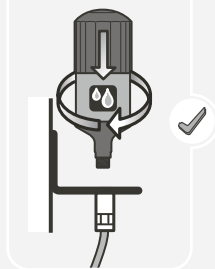
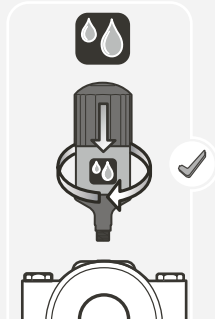
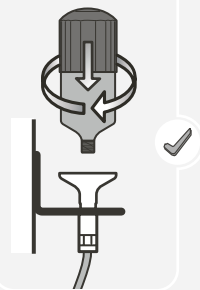
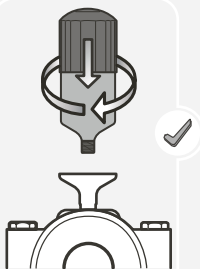

14

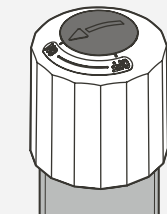
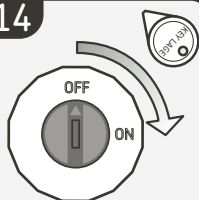

15

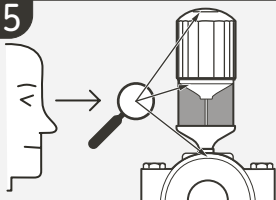

31 months	→	days
1M	> 4 x	< 7
3M	> 4 x	< 22
6M	> 6 x	< 30
9M	> 9 x	< 30
12M	> 12 x	< 30

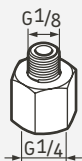
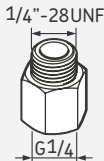
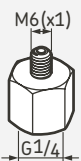
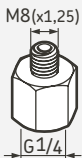
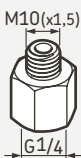
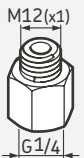
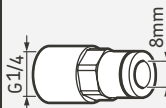
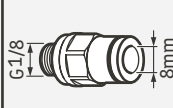
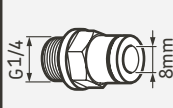
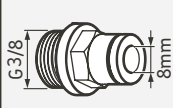
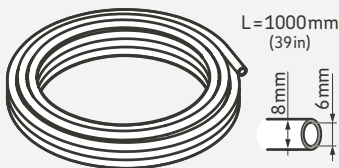
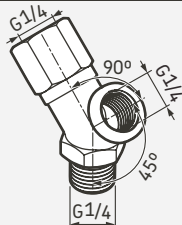
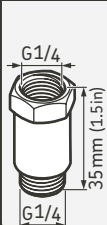
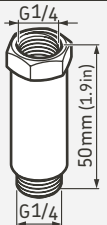
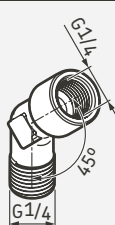
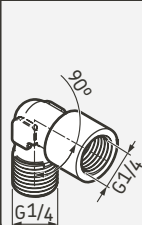
**LAPN 1/8****LAPN 1/4****LAPN 1/4UNF****LAPN 3/8****LAPN 1/2****LAPN 6****LAPN 8****LAPN 8x1****LAPN 10****LAPN 10x1****LAPN 12****LAPN 12x1,5****LAPF F1/4****LAPF M1/8****LAPF M1/4****LAPF M3/8****LAPT 1000****LAPT 5000****LAPM 2****LAPE 35****LAPE 50****LAPA 45****LAPA 90**

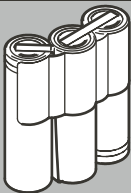
**LAGE 1-BAT****LAPG 1/4**

DIN 71412

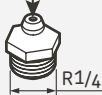
**LAPV 1/4**

G1/4

**LAPV 1/8**

G1/4

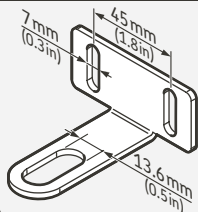
**LAPC 13****LAPP 63**

63 mm (2.5 in)

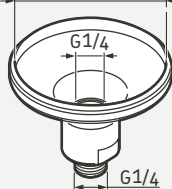
**LAPP 63V**

63 mm (2.5 in)

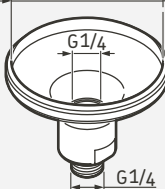
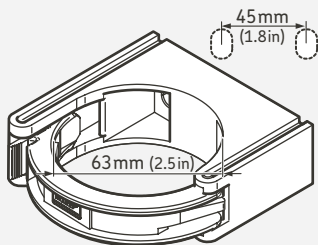
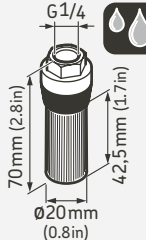
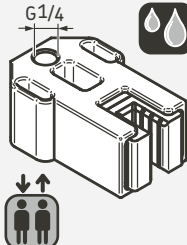
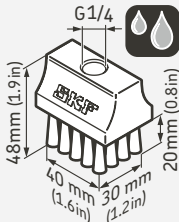
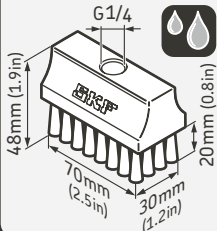
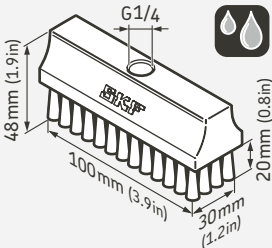
**LAPC 63****LAPB D2****LAPB 5-16E****LAPB 3x4E1****LAPB 3x7E1****LAPB 3x10E1**

*In line with our policy of continuous development of our products we reserve the right to alter any part of the above specification without prior notice.  
Although care has been taken to ensure the accuracy of this publication, SKF does not assume any liability for errors or omissions.*

*Gemäß unserer Firmenpolitik der ständigen Weiterentwicklung unserer Produkte behalten wir uns Änderungen der obigen Daten ohne Vorankündigung vor.*

*En línea con nuestra política de constante desarrollo de nuestros productos, nos reservamos el derecho a modificar cualquier parte de las especificaciones sin previa notificación.*

*Conformément à notre politique de développement continu de nos produits, nous nous réservons le droit de modifier, sans préavis, tout ou partie des spécifications ci-dessus.*

*In linea con la nostra politica di sviluppo continuo dei prodotti ci riserviamo il diritto di apportare modifiche senza preavviso a qualsiasi parte della presente documentazione.*

*In verband met onze politiek van continue ontwikkeling van onze producten, behouden wij ons het recht voor om de specificaties van de vermelde onderdelen te wijzigen zonder nota vooraf.*

*Em linha com a nossa política de desenvolvimento contínuo dos nossos produtos, reservamo-nos o direito de alterar este catálogo sem aviso prévio.*

*Tavoitteenamme on tuotteidemme jatkuva kehittäely. Pidätämme siksi oikeuden etukäteen ilmoittamatta muuttaa yllä olevia erittelyjä.*

*I linje med vår policy för kontinuerlig utveckling av våra produkter förbehåller vi oss rätten att ändra ovanstående specifikationer utan att meddela i förväg.*

*Σύμφωνα με την πολιτική της συνεχούς ανάπτυξης των προϊόντων μας, διατηρούμε το δικαίωμα να αλλάξουμε οποιοδήποτε μέρος των παραπάνω χαρακτηριστικών χωρίς προειδοποίηση.*

