



motralec
 4 rue Lavoisier . ZA Lavoisier . 95223 HERBLAY CEDEX
 Tel. : 01.39.97.65.10 / Fax. : 01.39.97.68.48
 Demande de prix / e-mail : service-commercial@motralec.com
www.motralec.com

**COMPANY
 WITH QUALITY SYSTEM
 CERTIFIED BY DNV
 =ISO 9001/2000=**

Water technology at your service

DRP - DGP - GRP - APP - SMP - SBP

Electropompes submersibles à roue **bicanal** ouverte, **vortex**, dotées de **broyeur**, à **hauteur d'élévation**, **monocanal** et **bicanal** fermée

*Bombas eléctricas sumergibles con impulsor de **doble canal** abierto, **vortex**, con **tritador**, de **altura de impulsión elevada**, de **un canal** y de **dos canales** cerrado*



Indiquées pour des utilisations poussées en milieu civil et industriel

Adecuadas para trabajos pesados en entornos civiles e industriales

Moteurs à bain d'huile de 2,4 à 15 kW - 2, 4 et 6 pôles

Motores de aceite de 2,4 a 15 kW - 2, 4 y 6 polos

Equipées de 3 joints mécaniques

Equipadas con 3 cierres mecánicos

Ample gamme de joints hydrauliques disponibles

Amplia gama de hidráulicas disponibles

50 Hz

Electropompes Série P

Bombas eléctricas Serie P

DRP - DGP - GRP - APP - SMP - SBP

Les électropompes industrielles **SERIE P** sont destinées à de lourds emplois professionnels exigeant des performances et une fiabilité élevées. Les nombreuses roues disponibles rendent ces modèles tout à fait polyvalents et adéquats à un secteur d'utilisations vaste. Las bombas eléctricas industriales **SERIE P** están destinadas a trabajos pesados y profesionales en los que se necesitan elevadas prestaciones y fiabilidad. Los numerosos impulsores disponibles convierten a estos modelos en versátiles e idóneos para un gran sector de utilizaciones.

Câble électrique d'alimentation

Longueur standard 10 m

Cable eléctrico de alimentación

Longitud estándar de 10 m

Moteur

à bain d'huile doté de protecteur thermique. Disponible dans la version 2, 4 et 6 pôles.

400 V 3~

Motor

en baño de aceite, con protección térmica. Disponible en la versión de 2, 4 y 6 polos.

400 V 3~

Carcasse

en fonte GJL-250. Protection IP68

Carcasa

de fundición GJL-250. Protección IP68

Roulements

à billes blindés et autolubrifiés à perpétuité.

Rodamientos

de bolas blindados y autolubricados de forma permanente

Trois joints mécaniques

Tres cierres mecánicos

(DRP - DGP - SMP - SBP)

Deux joints mécaniques

Dos cierres mecánicos

(GRP - APP)

Puisard huile pouvant être visité

Cámara de aceite con mirilla de inspección

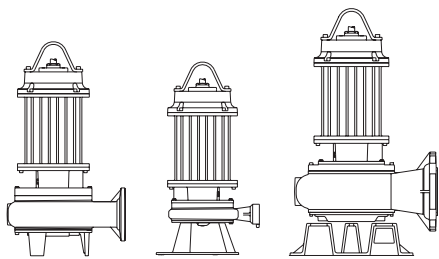

Pied de support/Bâti

Pied intégré dans le corps de la pompe.

Pour certains modèles est disponible un bâti spécifique pour une installation libre

Pie de soporte/Base

Pie integrado en el cuerpo de la bomba.

Para algunos modelos, está disponible una base específica para la instalación libre

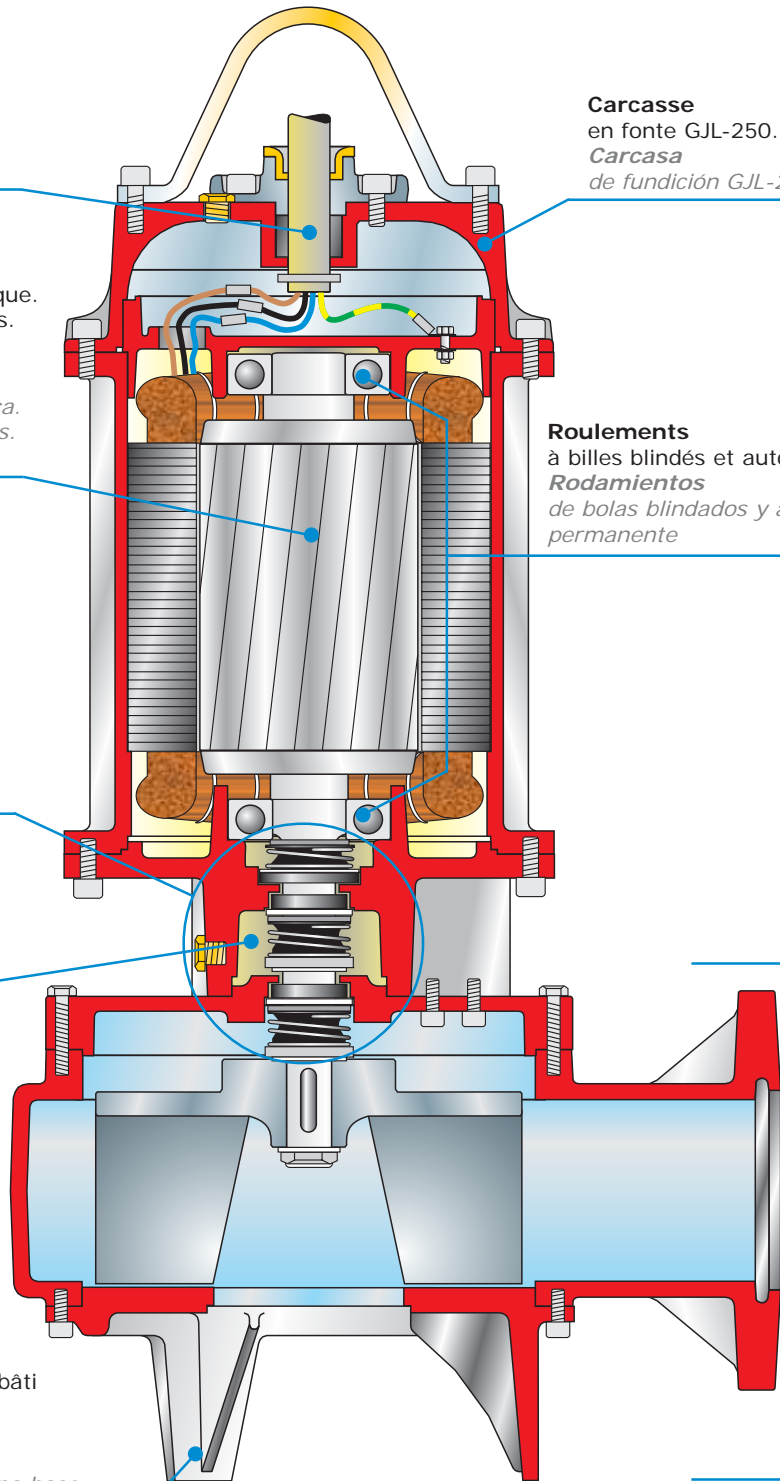

Règlements de référence:

DIRECTIVE MACHINES 89/392/CEE et modifications suivantes (directives 91/368/CEE, 93/68/CEE); DPR 547 de 1955; DPR 459 de 1996; DIRECTIVE BASSE TENSION 73/23/CEE; DIRECTIVE 89/336/CEE COMPATIBILITÉ ÉLECTROMAGNÉTIQUE;

Règles appliquées:

EN292-1 ; EN 292-2; CEI EN 60529; UNI EN ISO 9906; CEI EN 60034; CEI EN 60204; UNI EN 1561 – 1563; UNI EN 10098; UNI EN ISO 780
Procédures prévues par le Système de Qualité Zenit S.r.l. Certificat UNI EN 9001:2000, certificat DNV n° CERT 00660-95-AQ-BOL-SINCERT

Normativa de referencia:

DIRECTIVA DE MÁQUINAS 89/392/CEE y enmiendas posteriores (directivas 91/368/CEE, 93/68/CEE); DPR 547 de 1955; DPR 459 de 1996; DIRECTIVA DE BAJA TENSION 73/23/CEE; DIRECTIVA 89/336/CEE DE COMPATIBILIDAD ELECTROMAGNÉTICA;

Normas aplicadas:

EN292-1 ; EN 292-2; CEI EN 60529; UNI EN ISO 9906; CEI EN 60034; CEI EN 60204; UNI EN 1561 – 1563; UNI EN 10098; UNI EN ISO 780
Procedimientos previstos por el Sistema de Calidad Zenit S.r.l. Certificado UNI EN 9001:2000, certificado DNV n° CERT 00660-95-AQ-BOL-SINCERT

Roues et joints hydrauliques disponibles

Rotores e hidráulicas disponibles



DRENO (DR)

Page
Página 4

Roue BICANAL OUVERTE.
Prévue pour le traitement d'eaux faiblement chargées ou chargées.
Impulsor DE DOS CANALES ABIERTO.
Indicado para el tratamiento de aguas cargadas o ligeramente cargadas.

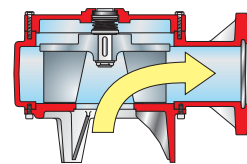

DRAGA (DG)

Page
Página 11

Roue de type VORTEX. Passage libre intégral.
Prévue pour le traitement d'eaux résiduaires avec des corps solides en suspension.
Impulsor de tipo VORTEX. Paso libre integral.
Indicado para el tratamiento de aguas residuales con cuerpos sólidos en suspensión.

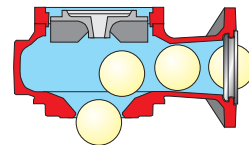

GRINDER (GR)

Page
Página 15

Roue MULTICANAL OUVERTE avec système de BROYAGE. Prévue pour le traitement d'eaux très chargées avec des corps solides et filamenteux.
Le couteau déchiquète finement les fibres éventuellement présentes à l'aspiration.
Impulsor DE CANALES MÚLTIPLES ABIERTO con sistema de TRITURACIÓN. Indicado para el tratamiento de aguas muy cargadas con cuerpos sólidos y filamentosos.
La cuchilla desgarrar finamente las fibras que puedan quedar en la aspiración.

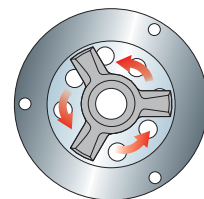

Alta Prevalenza (AP)

Page
Página 15

Roue MULTICANAL OUVERTE à HAUTEUR D'ELEVATION. Prévue pour le traitement d'eaux claires ou peu chargées. Un usinage tout particulier au dos et sur le côté de la roue permet le déchiquetage et l'éjection de corps fibreux.
Impulsor DE CANALES MÚLTIPLES ABIERTO DE ALTURA DE IMPULSIÓN ELEVADA. Indicado para el tratamiento de aguas claras o poco cargadas. Un mecanizado especial en la parte trasera y en el lateral del impulsor permite desgarrar y expulsar cuerpos fibrosos.

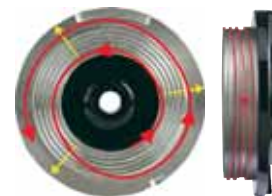

SYSTEM M (SM)

Page
Página 16

Roue MONOCANAL FERMEE. Prévue pour le traitement d'eaux chargées avec des corps solides en suspension. Ample passage libre.
Impulsor DE UN CANAL CERRADO. Indicado para el tratamiento de aguas cargadas con cuerpos sólidos en suspensión. Amplio paso libre.

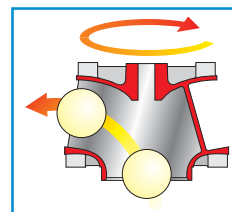

SYSTEM M (SB)

Page
Página 16

Roue BICANAL FERMEE. Prévue pour le traitement d'eaux chargées avec des corps solides en suspension. Ample passage libre.
Impulsor DE DOS CANALES CERRADO. Indicado para el tratamiento de aguas cargadas con cuerpos sólidos en suspensión. Amplio paso libre.

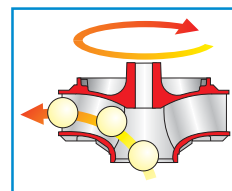

Matériaux de construction et limites d'utilisation

Materiales de fabricación y límites de uso

Ensemble mécanique	Fonte EN-GJL-250
Arbre	Acier X30Cr13 (AISI420)
Joints (O-Ring)	Caoutchouc NBR-SBR
Roue	Fonte EN-GJL-250
Visserie	Acier INOX A2
Peinture	Epoxy-vinylque écologique
Garnitures mécaniques(*)	carbure de silice/graphite alumine

Conjunto mecánico	Fundición EN-GJL-250
Eje	Acero X30Cr13 (AISI420)
Juntas (O-Ring)	Goma NBR-SBR
Impulsor	Fundición EN-GJL-250
Tornillos	Acero INOX A2
Pintura	Epoxivinilica ecológica
Cierres mecánicos(*)	carburo de silicio/grafito alumina

(*): Sur demande, double garniture en carbure de silice *Bajo pedido, 2 cierres mecánicos en carburo de silicio*

Temp. d'utilisation maxi	40 °C
PH liquide	de 6 à 10
Viscosité liquide	1 mm ² /s
Service	S1
Prof. immersion maxi	20 m
Densité liquide	1 kg/dm ³
Press. acoustique maxi	< 70 dB dB
Démarrages/heure maxi	10

Temp. de uso máx.	40 °C
PH del líquido	de 6 a 10
Viscosidad del líquido	1 mm ² /s
Servicio	S1
Prof. de inmersión máx	20 m
Densidad del líquido	1 kg/dm ³
Pres. acústica máx	< 70 dB dB
Arranques / hora máx	10

Modèles DRENO (DRP)

Modelos DRENO (DRP)

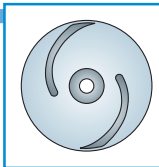

Bicanal ouverte
Bicanal abierto



Regroupements de courbes hydrauliques

Conjuntos de curvas hidráulicas

REGROUPEMENT CONJUNTO

A

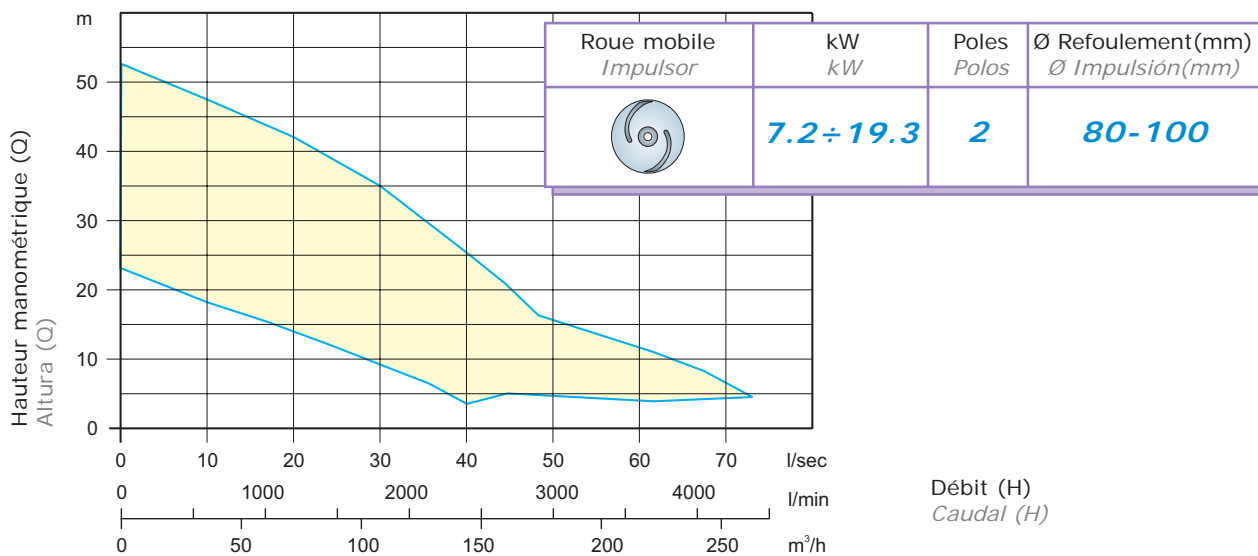

REGROUPEMENT CONJUNTO

B

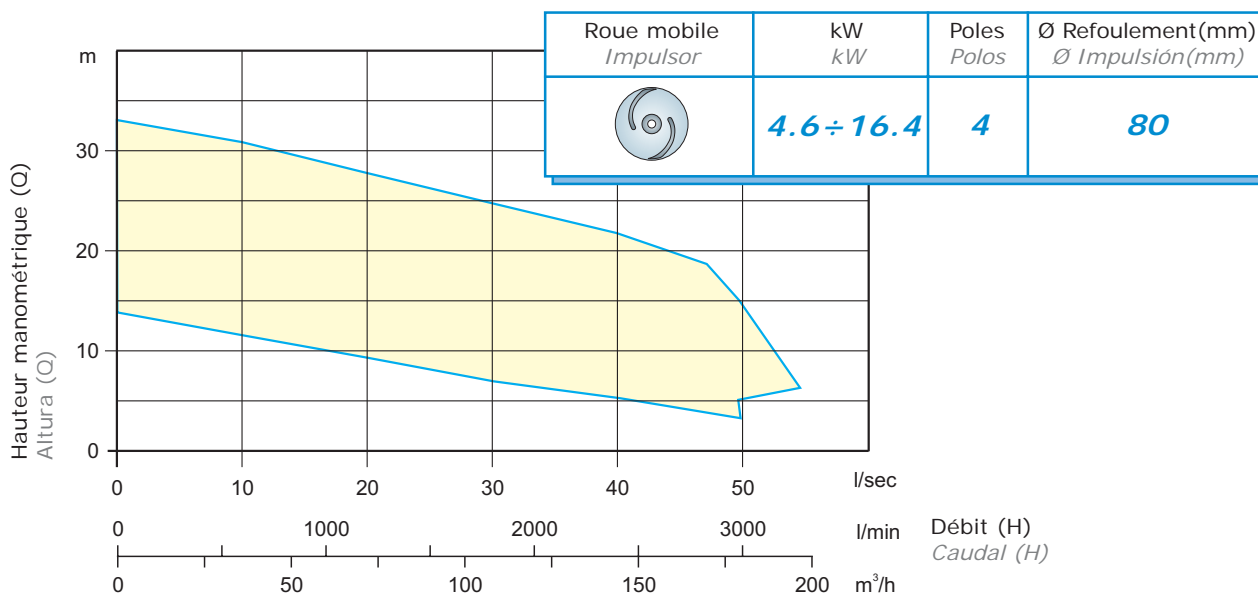

REGROUPEMENT CONJUNTO

C

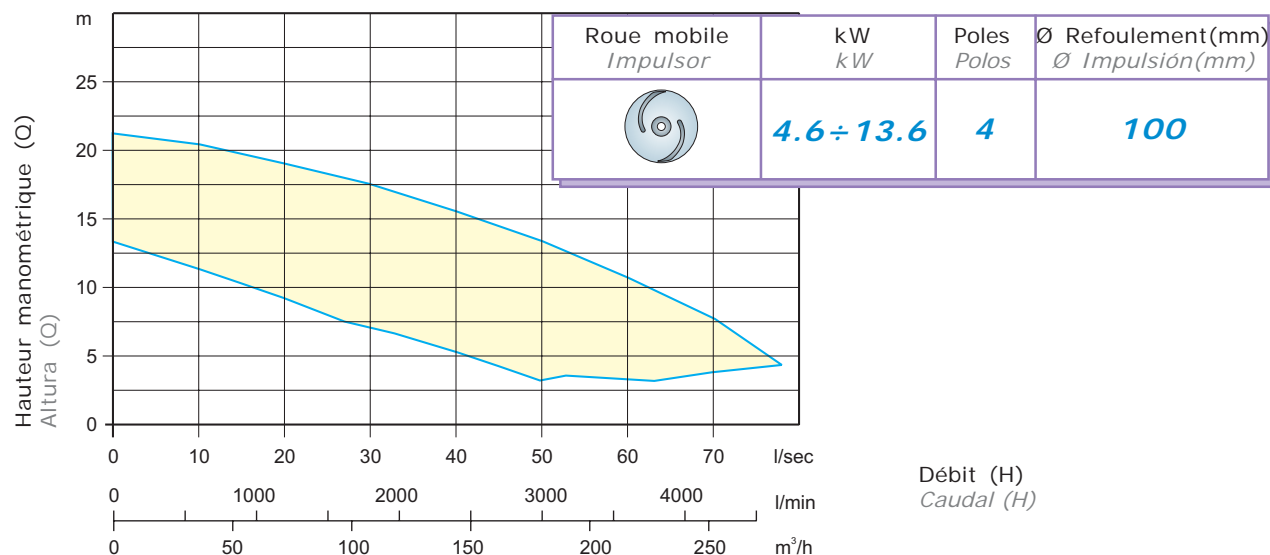

REGROUPEMENT CONJUNTO

D

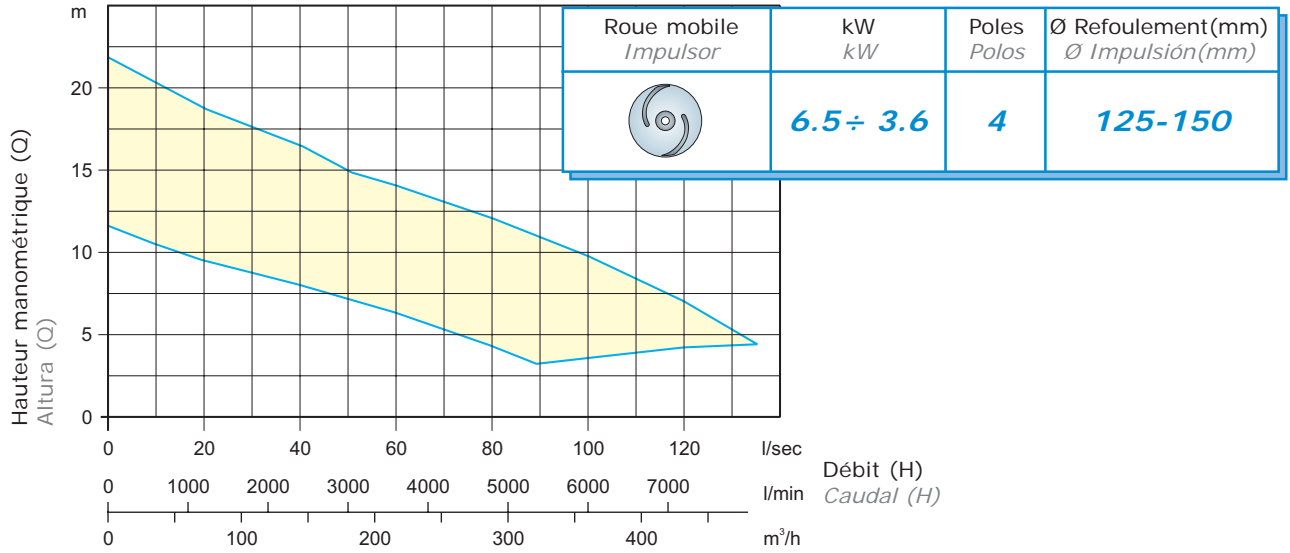

REGROUPEMENT CONJUNTO

E

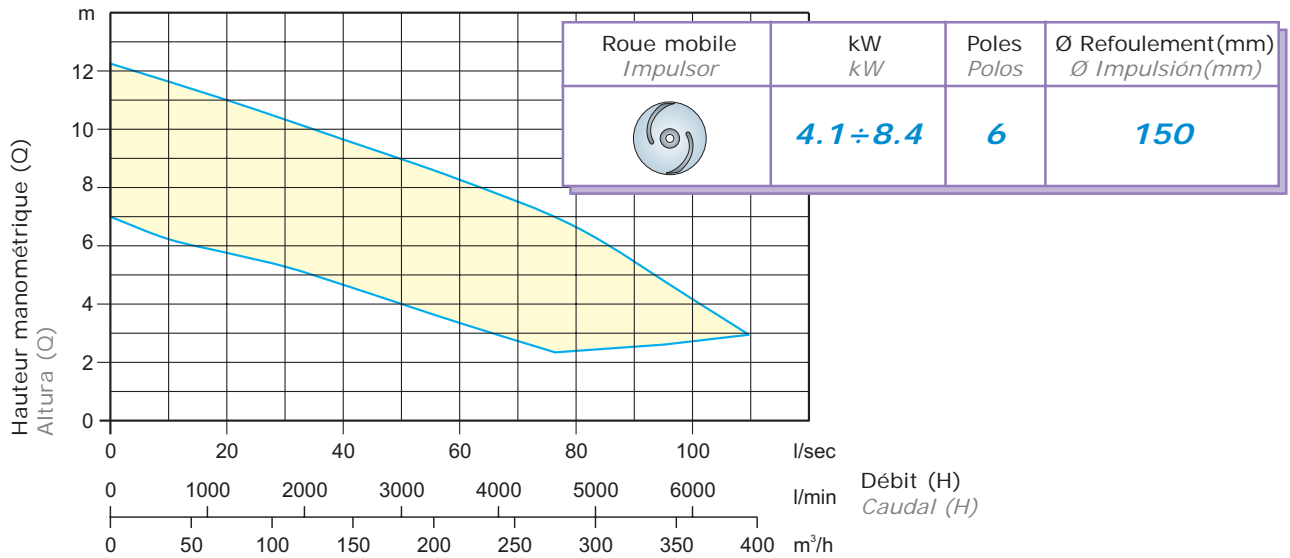

Courbes hydrauliques - DRP Curvas hidráulicas - DRP

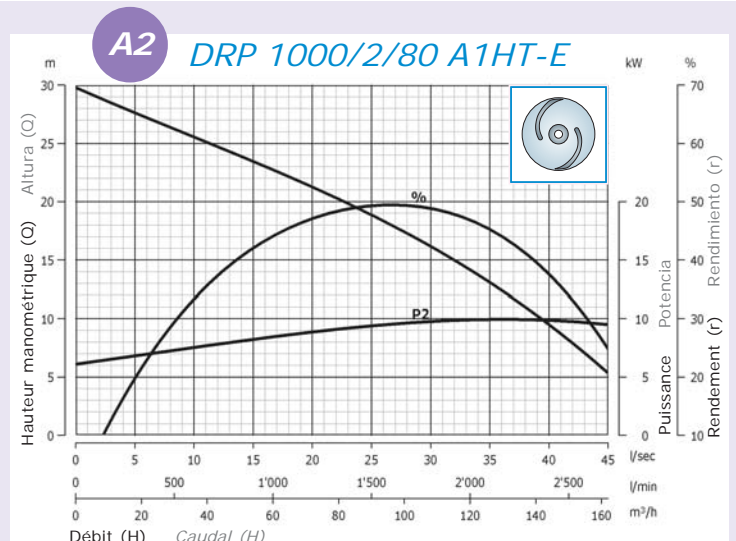
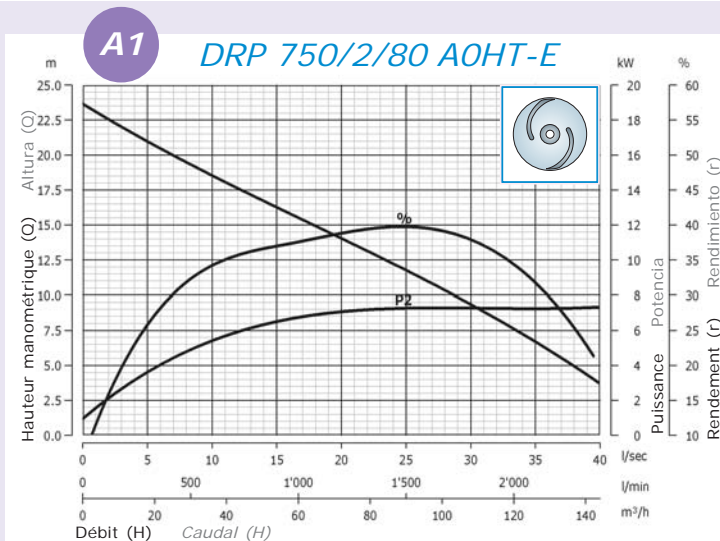

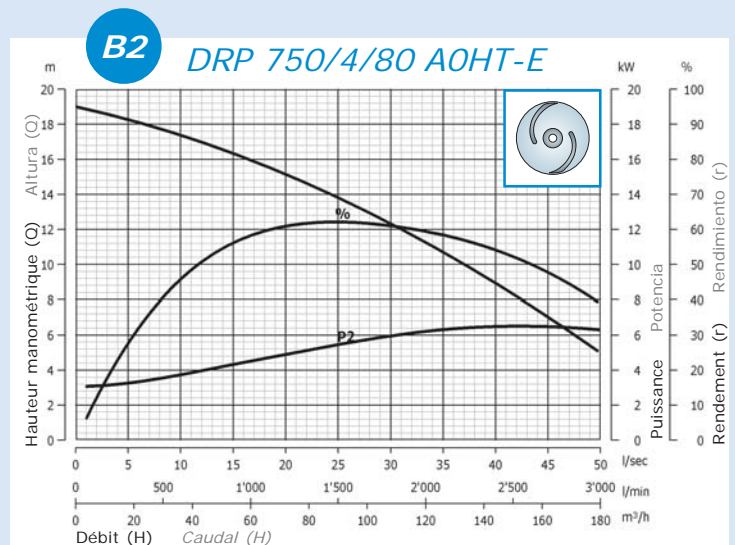
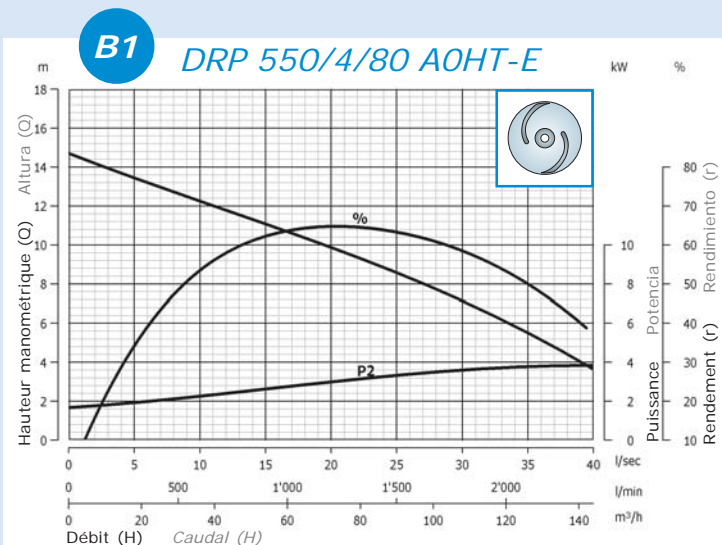
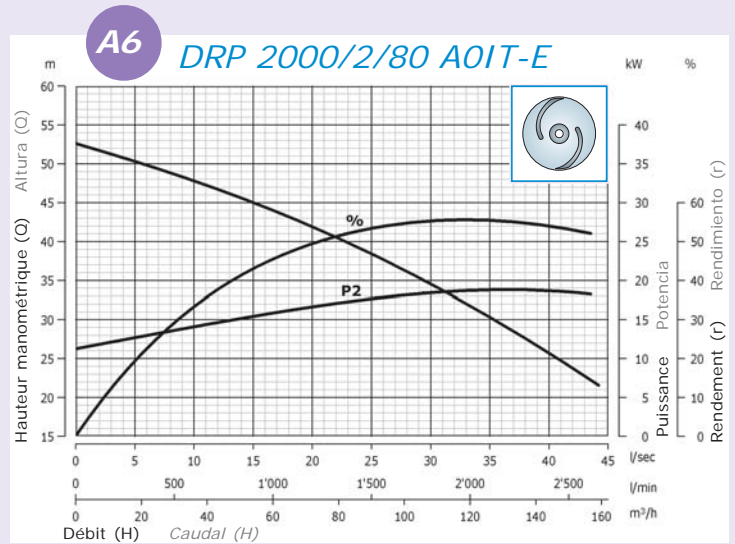
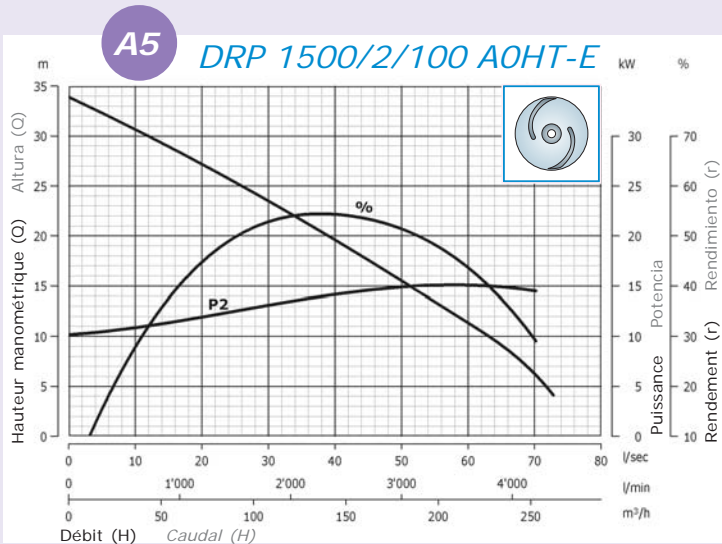
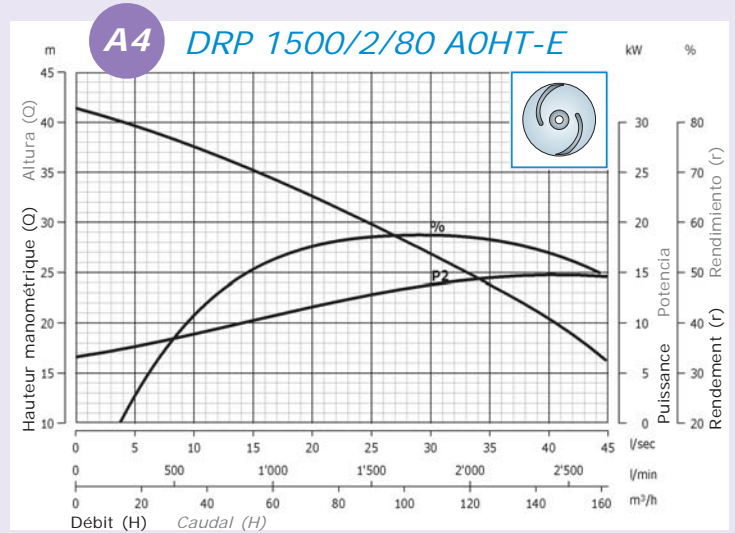
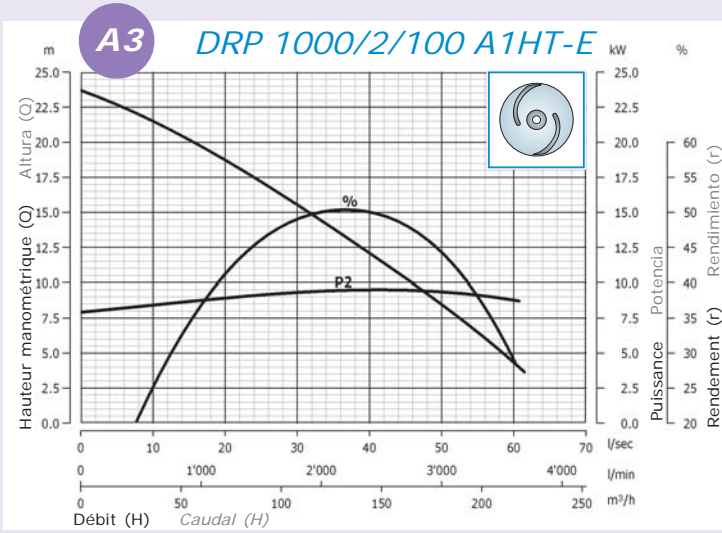

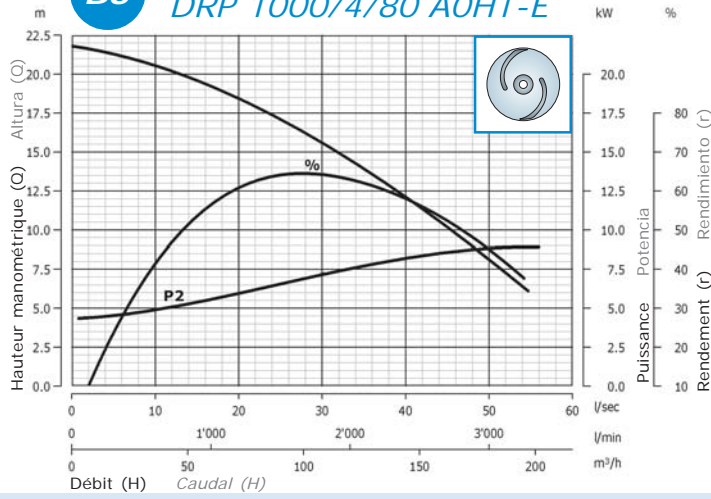
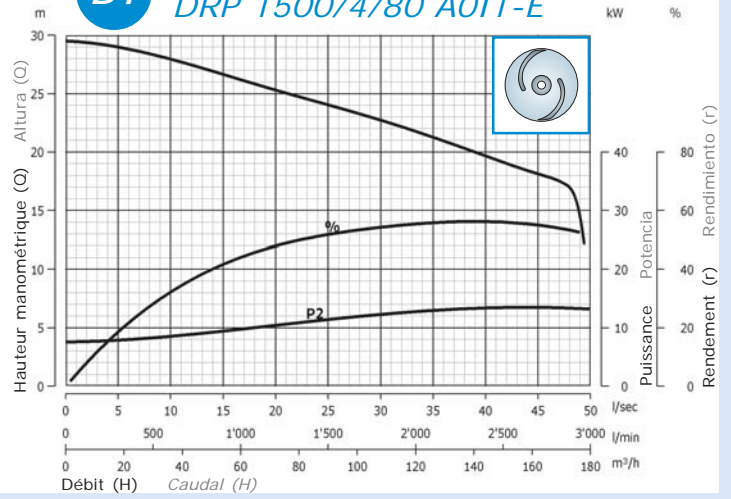
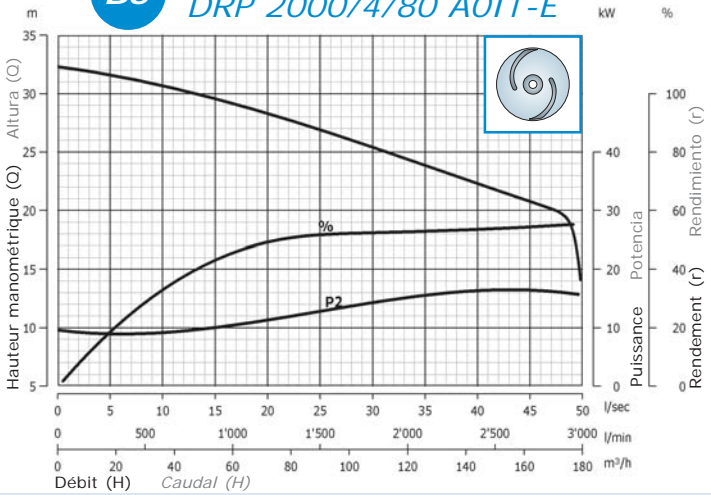
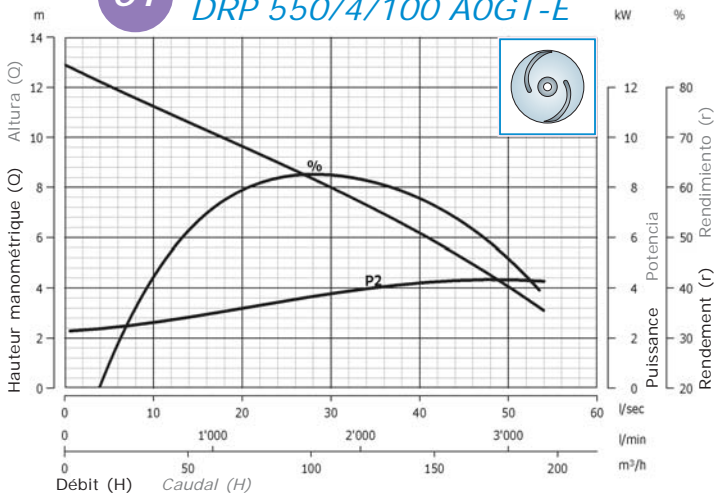
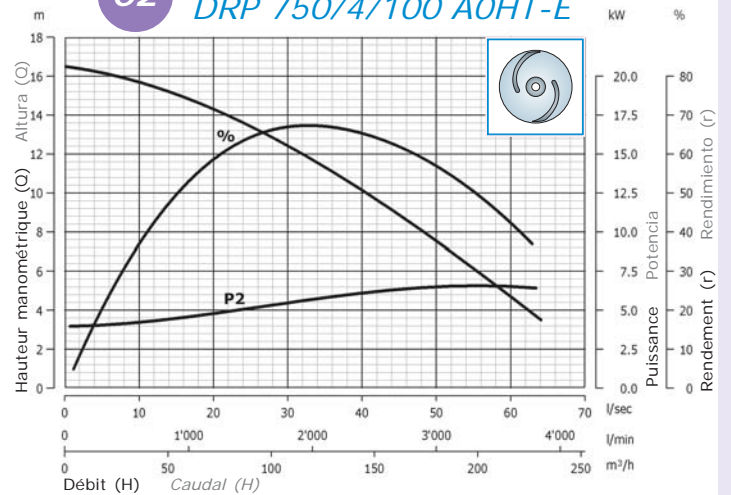
B3**DRP 1000/4/80 AOHT-E****B4****DRP 1500/4/80 AOIT-E****B5****DRP 2000/4/80 AOIT-E****C1****DRP 550/4/100 A0GT-E****C2****DRP 750/4/100 AOHT-E**

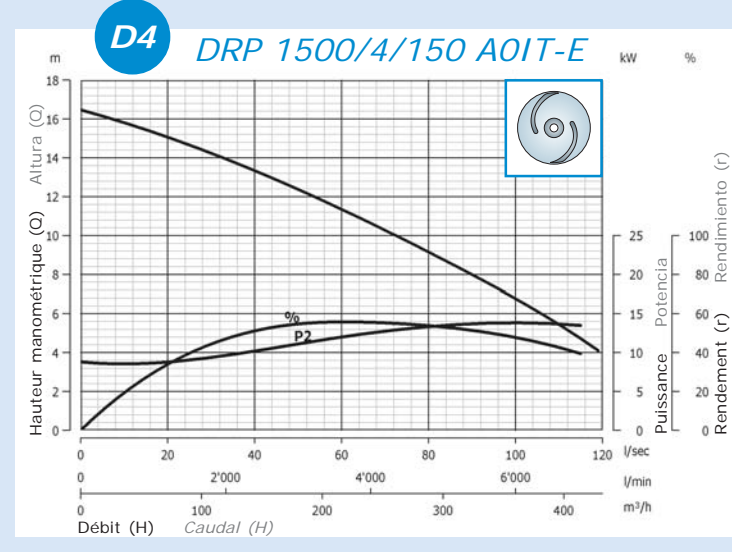
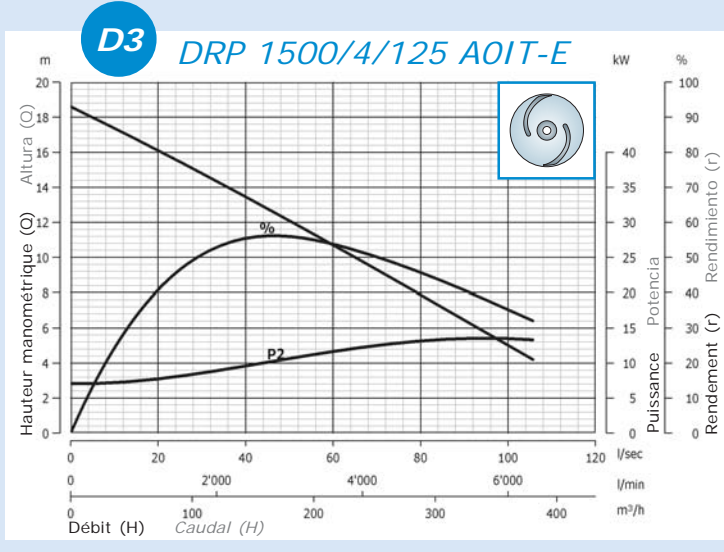
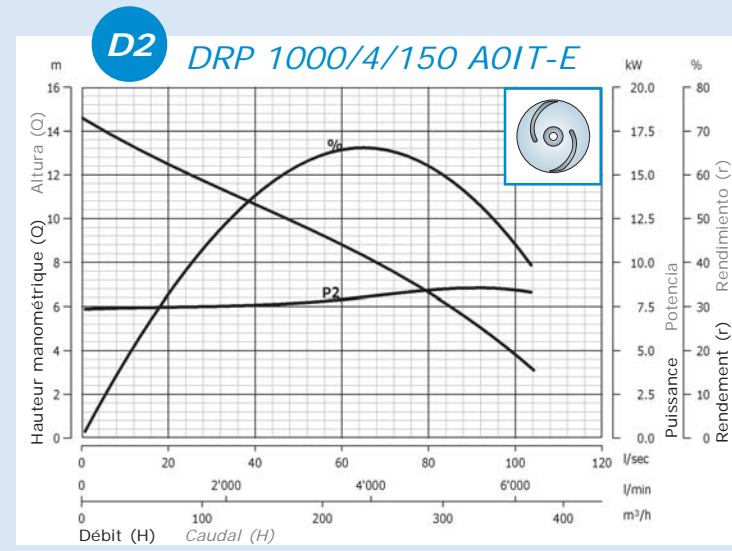
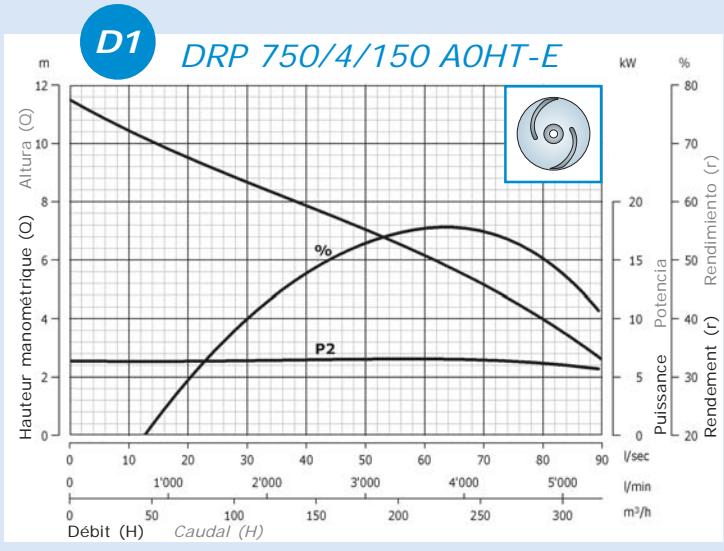
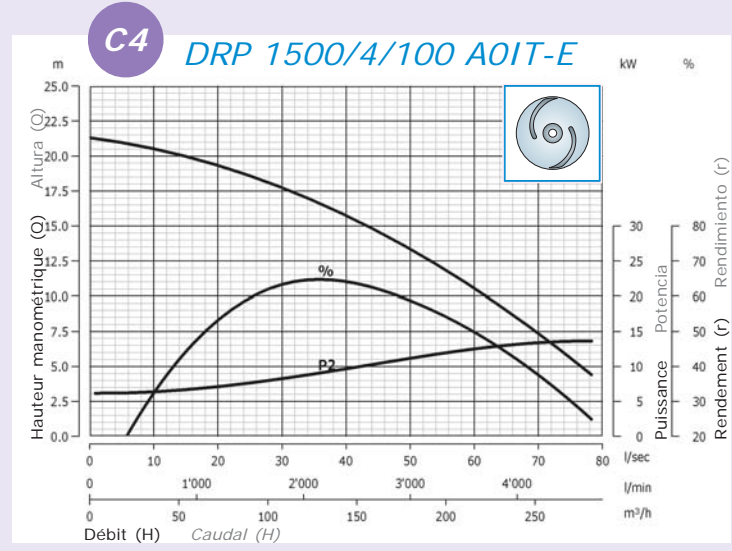
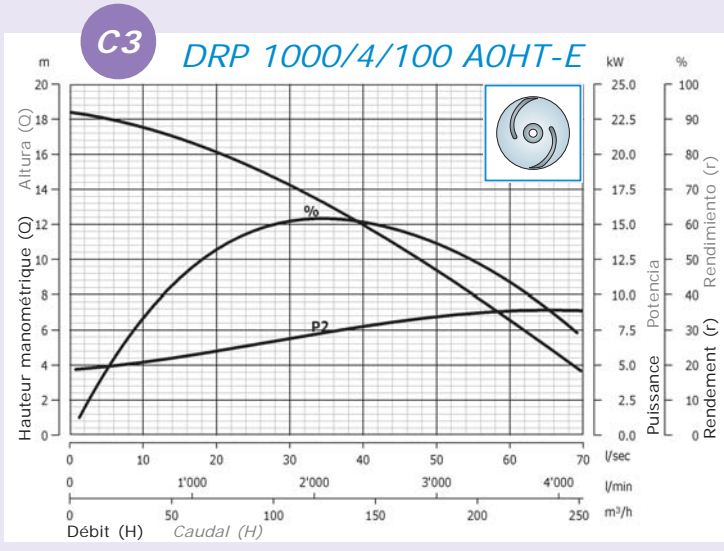

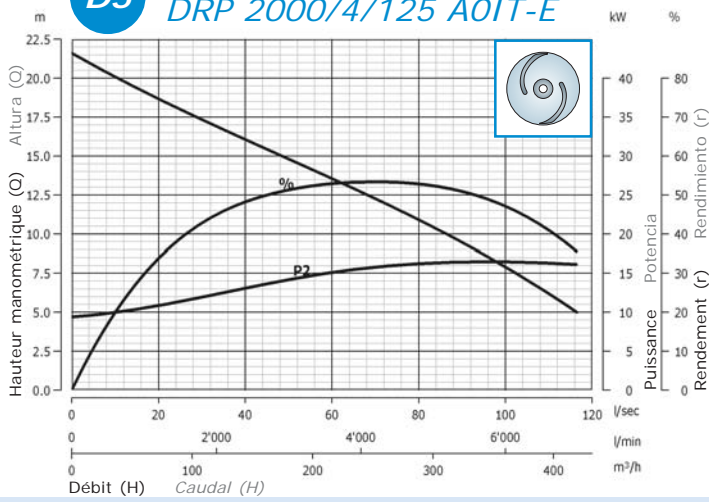
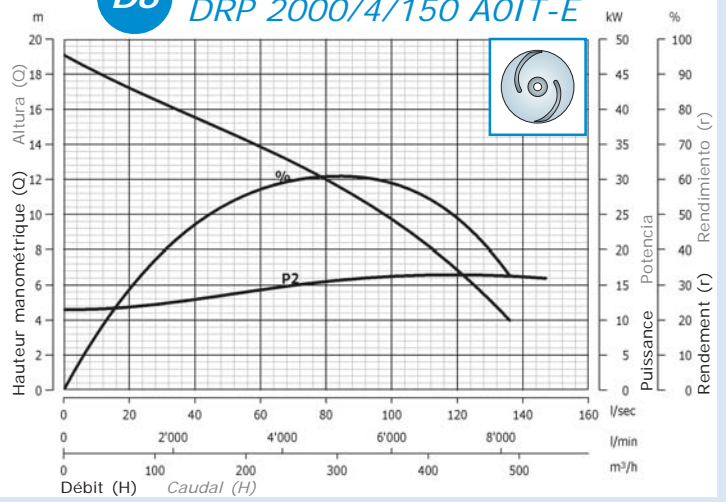
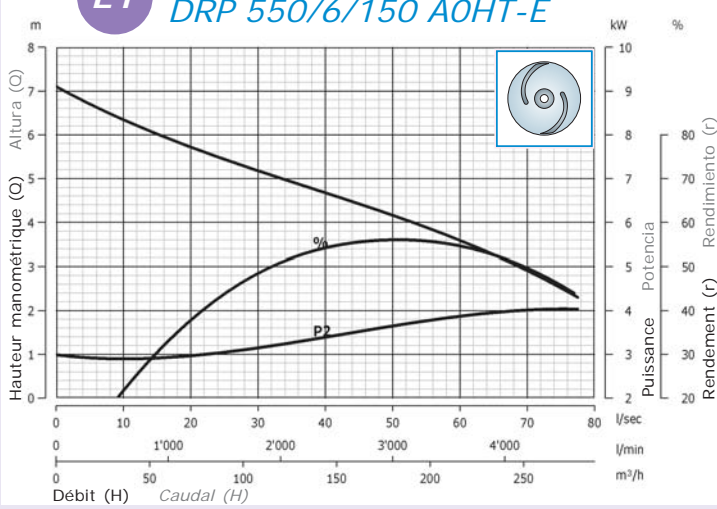
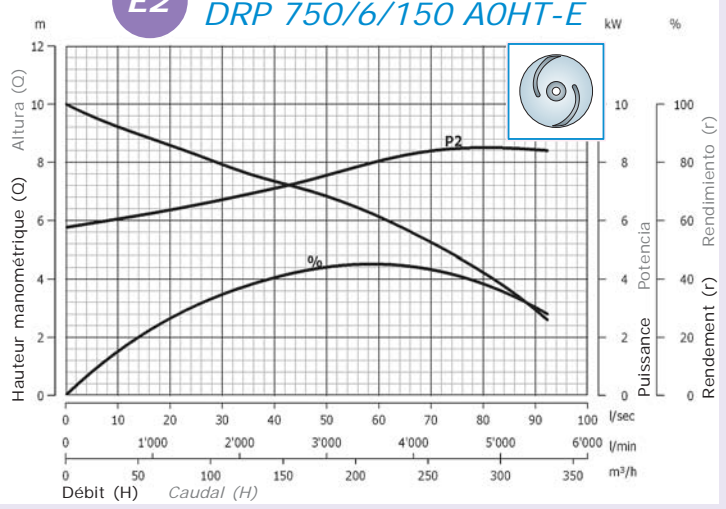
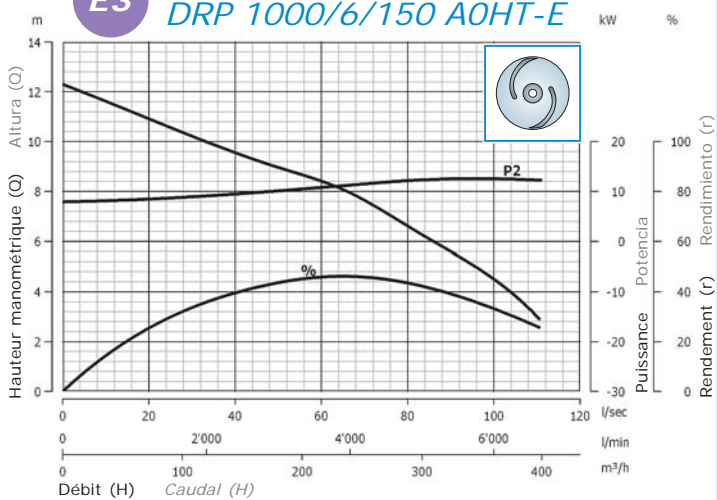
D5**DRP 2000/4/125 AOIT-E****D6****DRP 2000/4/150 AOIT-E****E1****DRP 550/6/150 AOHT-E****E2****DRP 750/6/150 AOHT-E****E3****DRP 1000/6/150 AOHT-E**

Données hydrauliques - DRP

Datos hidráulicos - DRP

	kW	Passaggio libero(mm)	I/s													
			I/min													
			0	2	4	8	16	24	40	50	60	75	90	105	120	
			0	120	240	480	960	1440	2400	3000	3600	4500	5400	6300	7200	
			m ³ /h	0	7.2	14.4	28.8	57.6	86.4	144	180	216	270	324	378	432
DRP 750/2/80 AOHT	6.5	63	23.6	22.5	21.5	19.5	15.8	12.2	9.5							
DRP 1000/2/80 A1HT	8.9	65	29.8	28.9	28	26.4	23	19.4	12.1	8.5	4.3					
DRP 1000/2/100 A1HT	8.9	80	23.7	23.3	22.9	22	19.9	17.5	20.4							
DRP 1500/2/80 AOHT	13.6	60	41.4	40.7	40	38.4	34.7	30.4	19.6	15.5	11.4					
DRP 1500/2/100 AOHT	13.6	80	33.9	33.3	32.6	31.3	28.5	25.7	25.7							
DRP 2000/2/80 AOIT	16.4	54	52.6	51.7	50.8	48.8	44.4	39.1								
DRP 550/4/80 AOGT	4.6	67	14.7	14.2	13.7	12.7	10.8	8.8								
DRP 550/4/100 AOGT	4.6	76	12.9	12.6	12.2	11.6	10.3	9	6.2	4.1						
DRP 750/4/80 AOHT	6.5	70	19	18.7	18.4	17.7	16.1	14.1	8.9							
DRP 750/4/100 AOHT	6.5	76	16.5	16.4	16.3	15.9	14.9	13.6	10.1	7.5	4.7					
DRP 750/4/150 AOHT	6.5	93	11.5	11.3	11.1	10.6	9.9	9.2	7.9	7	6.2	4.6	2.6			
DRP 1000/4/80 AOHT	8.9	70	21.8	21.6	21.4	20.9	19.4	17.4	12.1	8.1						
DRP 1000/4/100 AOHT	8.9	76	18.4	18.3	18.1	17.8	16.7	15.4	12	9.4	6.6					
DRP 1000/4/150 AOHT	8.9	93	14.6	14.4	14.1	13.7	12.9	12.1	10.7	9.8	8.8	7.2	5.3			
DRP 1500/4/80 AOIT	13.6	70	29.5	29.4	29.1	28.4	26.4	24.3	19.7							
DRP 1500/4/100 AOIT	13.6	77	21.3	21.2	21	20.7	19.8	18.7	15.7	13.3	10.6	5.6				
DRP 1500/4/125 AOIT	13.6	110	18.6	18.4	18.1	17.6	16.6	15.6	13.5	12.1	10.7	8.6	6.5	4.3		
DRP 1500/4/150 AOIT	13.6	120	16.5	16.3	16.2	15.9	15.4	14.7	13.3	12.4	11.3	9.7	8	6.1		
DRP 2000/4/80 AOIT	16.4	70	32.3	32	31.8	31.1	29.3	27.2	22.3							
DRP 2000/4/125 AOIT	16.4	110	21.6	21.3	21	20.4	19.2	18.1	16.1	14.8	13.5	11.6	9.5	7.1		
DRP 2000/4/150 AOIT	16.4	120	19.1	18.9	18.7	18.3	17.6	16.9	15.5	14.7	13.9	12.5	10.9	9.1	6.9	
DRP 550/6/150 AOHT	4.6	115	7.1	6.9	6.8	6.5	6	5.5	4.7	4.2	3.6	2.5				
DRP 750/6/150 AOHT	6.5	95	10	9.8	9.7	9.4	8.8	8.3	7.3	6.8	6.1	4.8	2.9			
DRP 1000/6/150 AOIT	8.9	93	12.3	12.2	12	11.8	11.2	10.6	9.6	9	8.4	7.1	5.6	3.8		

Tableau données techniques - DRP

Tabla de datos técnicos - DRP

Corbe	Code	Modèle	Refoulement	Passage libre		Puissance (kW)		Pôles		Courant (A)		Câble	Kg
				Paso libre	Potencia (kW)	P1	P2	Polos	V/~	Corrente (A)	Run		
Curva	Código	Modelo	Caudal	(mm)								Cable	
A1	0068	DRP 750/2/80 AOHT-E	DN 80	63	8.7	7.2	2	400/3	14.5	60	7G1.5+3x0.75	100	
A2	0793	DRP 1000/2/80 A1HT-E	DN 80	65	11.9	10	2	400/3	19.8	87.8	7G1.5+3x0.75	105	
A3	0794	DRP 1000/2/100 A1HT-E	DN 100	80	11.9	10	2	400/3	19.8	87.8	7G1.5+3x0.75	108	
A4	0071	DRP 1500/2/80 AOHT-E	DN 80	60	17.3	15	2	400/3	28.2	140	7G2.5+3x0.75	128	
A5	0072	DRP 1500/2/100 AOHT-E	DN 100	80	17.3	15	2	400/3	28.2	140	7G2.5+3x0.75	130	
A6	0073	DRP 2000/2/80 AOIT-E	DN 80	54	22	19.3	2	400/3	36	159.6	2x4G6 - 2x1	158	
B1	0078	DRP 550/4/80 AOGT-E	DN 80	67	5.8	4.6	4	400/3	10.1	40	4G2.5+3x1	82	
C1	0079	DRP 550/4/100 AOGT-E	DN 100	76	5.8	4.6	4	400/3	10.1	40	4G2.5+3x1	85	
B2	0080	DRP 750/4/80 AOHT-E	DN 80	70	7.9	6.5	4	400/3	14.9	68	7G1.5+3x0.75	125	
C2	0081	DRP 750/4/100 AOHT-E	DN 100	76	7.9	6.5	4	400/3	14.9	68	7G1.5+3x0.75	123	
D1	0082	DRP 750/4/150 AOHT-E	DN 150	93	7.9	6.5	4	400/3	14.9	68	7G1.5+3x0.75	138	
B3	0083	DRP 1000/4/80 AOHT-E	DN 80	70	10.8	8.9	4	400/3	20	102	7G1.5+3x0.75	133	
C3	0084	DRP 1000/4/100 AOHT-E	DN 100	76	10.8	8.9	4	400/3	20	102	7G1.5+3x0.75	131	
D2	0085	DRP 1000/4/150 AOHT-E	DN 150	93	10.8	8.9	4	400/3	20	102	7G1.5+3x0.75	146	
B4	0086	DRP 1500/4/80 AOIT-E	DN 80	70	15.8	13.6	4	400/3	28.2	110	2x4G6 - 2x1	181	
C4	0087	DRP 1500/4/100 AOIT-E	DN 100	77	15.8	13.6	4	400/3	28.2	110	2x4G6 - 2x1	171	
D3	0088	DRP 1500/4/125 AOIT-E	DN 125	110	15.8	13.6	4	400/3	28.2	110	2x4G6 - 2x1	199	
D4	0089	DRP 1500/4/150 AOIT-E	DN 150	120	15.8	13.6	4	400/3	28.2	110	2x4G6 - 2x1	213	
B5	0090	DRP 2000/4/80 AOIT-E	DN 80	70	19.6	16.4	4	400/3	36	151	2x4G6 - 2x1	196	
D5	0091	DRP 2000/4/125 AOIT-E	DN 125	110	19.6	16.4	4	400/3	36	151	2x4G6 - 2x1	220	
D6	0092	DRP 2000/4/150 AOIT-E	DN 150	120	19.6	16.4	4	400/3	36	151	2x4G6 - 2x1	228	
E1	0097	DRP 550/6/150 AOHT-E	DN 150	115	5.2	4.1	6	400/3	10.7	47.5	7G1.5+3x0.75	141	
E2	0098	DRP 750/6/150 AOHT-E	DN 150	95	8.1	6.1	6	400/3	15.2	67.4	7G1.5+3x0.75	189	
E3	0099	DRP 1000/6/150 AOIT-E	DN 150	93	11	8.4	6	400/3	20.1	89.1	4G6+2x1	211	

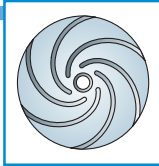

VORTEX



Regroupements de courbes hydrauliques
Conjuntos de curvas hidráulicas

**REGROUPEMENT
 CONJUNTO**

F

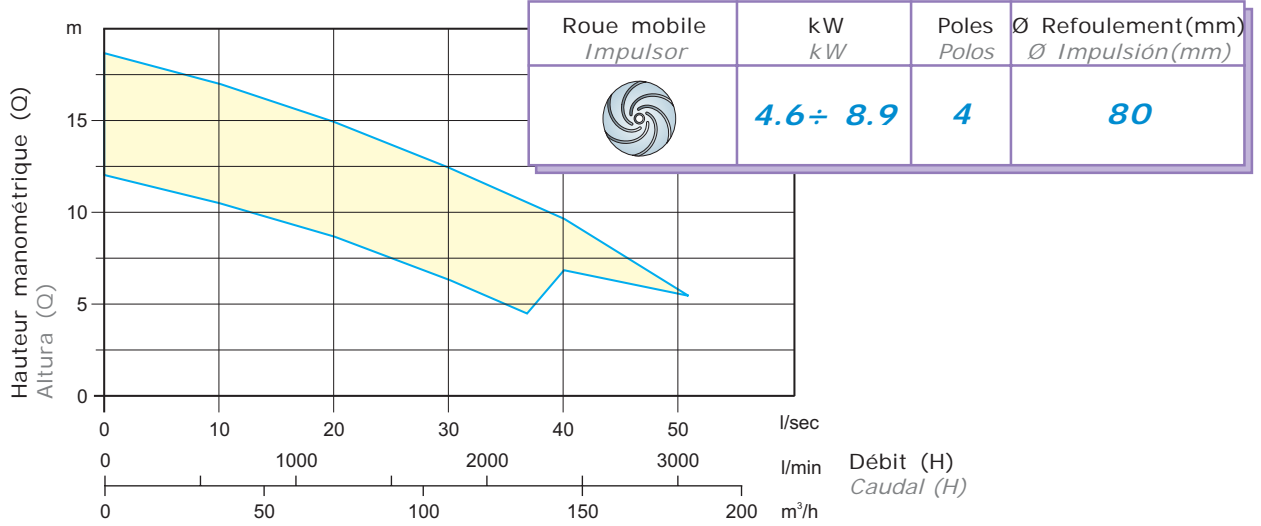

**REGROUPEMENT
 CONJUNTO**

G

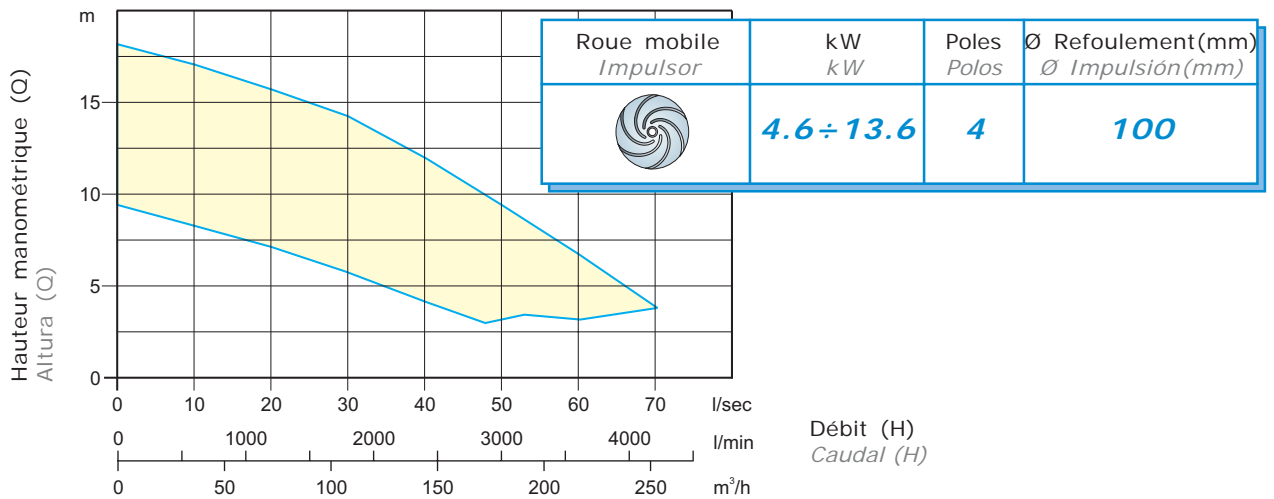

**REGROUPEMENT
 CONJUNTO**

H

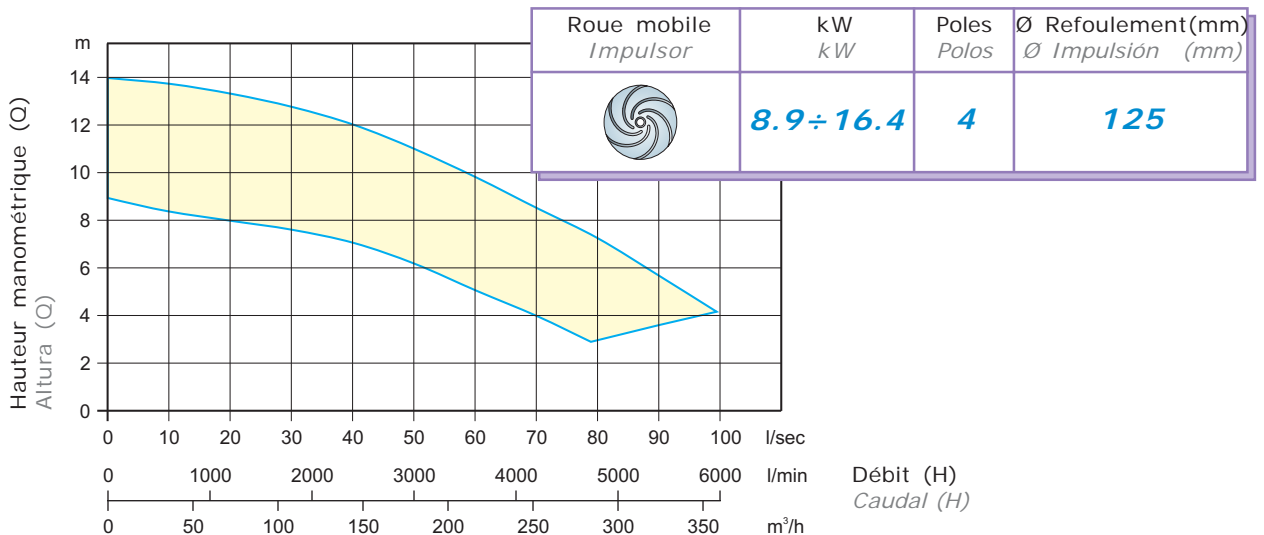

Courbes hydrauliques - DGP

Curvas hidráulicas - DGP

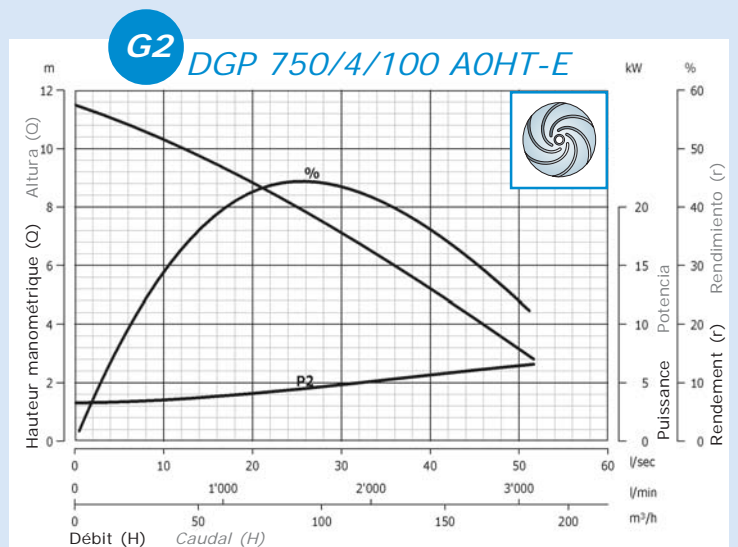
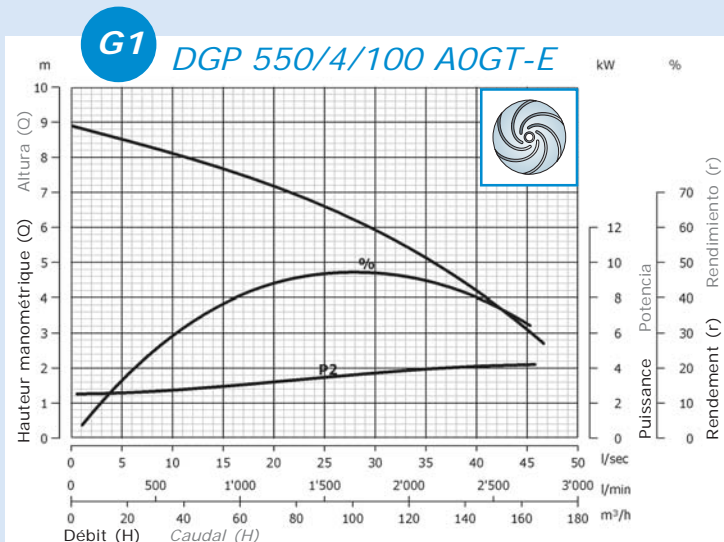
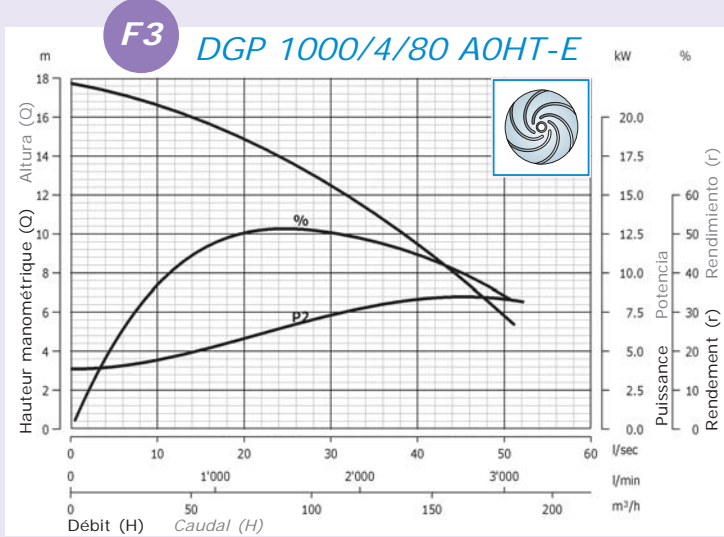
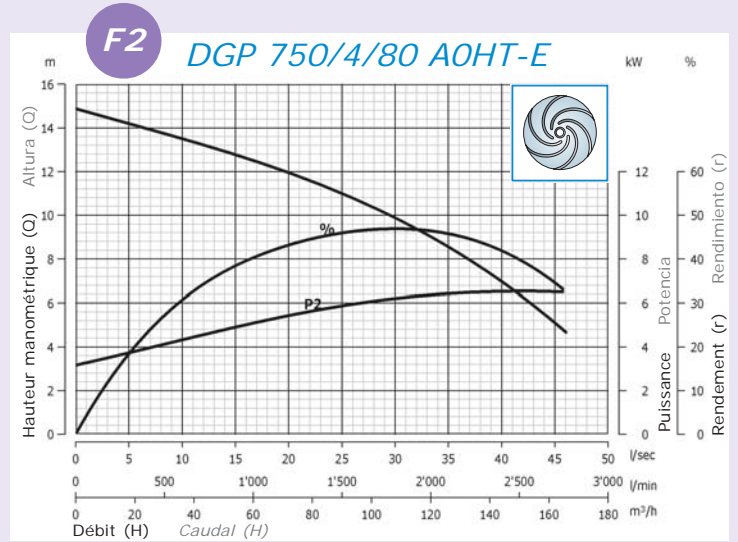
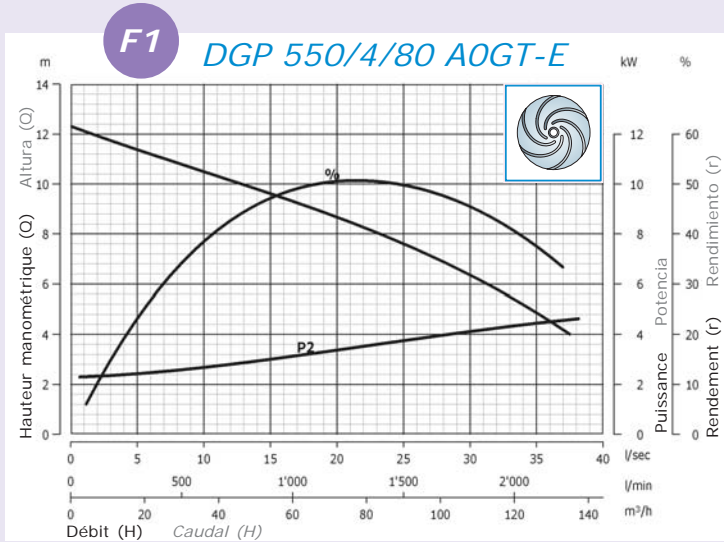

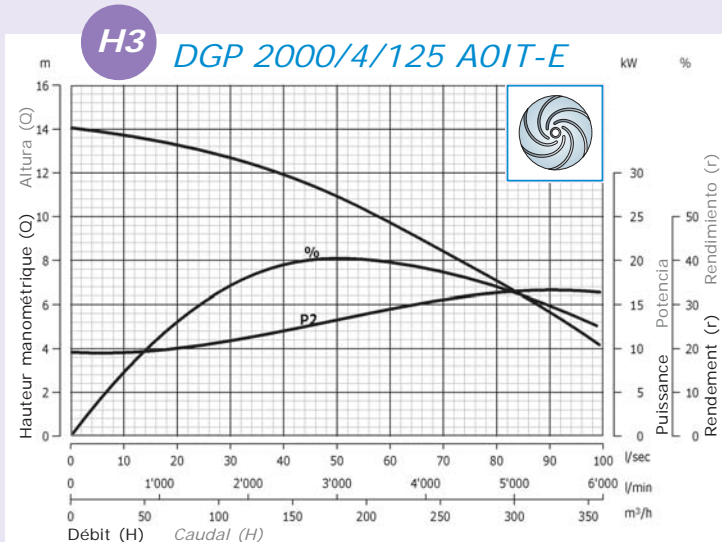
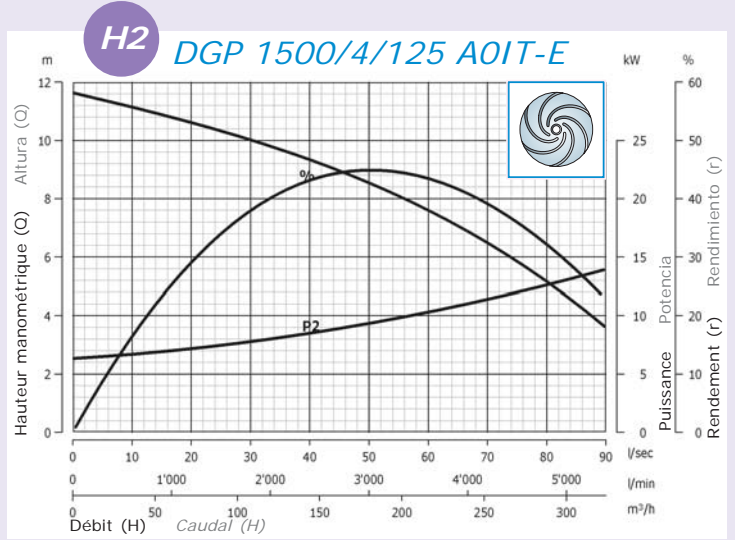
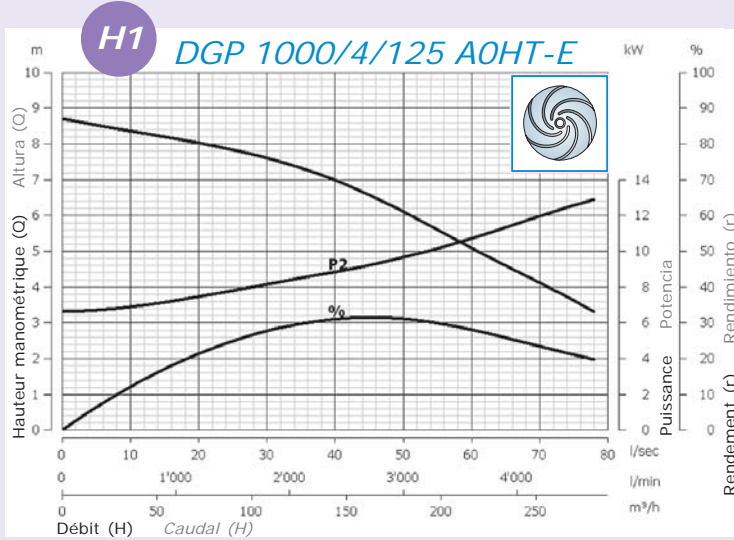
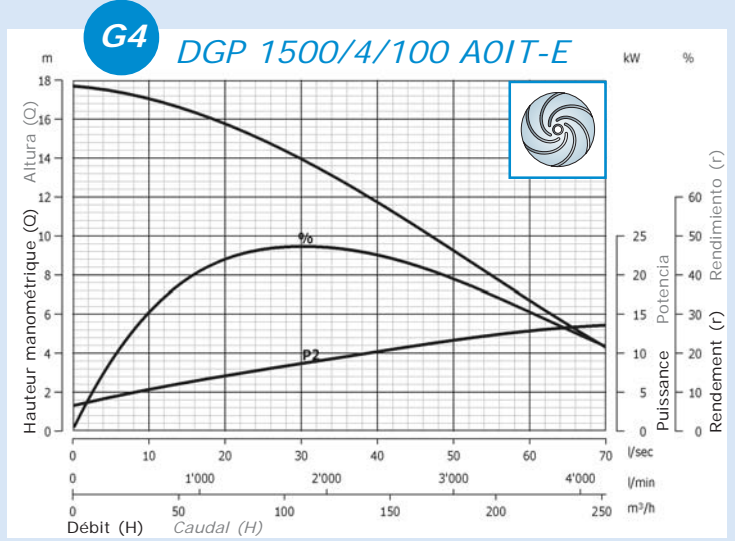
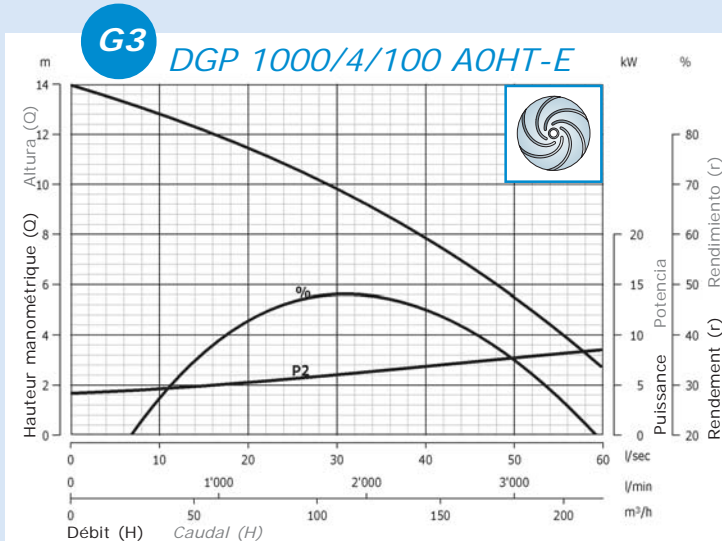

Données hydrauliques - DGP

Datos hidráulicos - DGP

	kW	Passaggio libero(mm)	I/s	0	5	10	15	20	25	30	35	40	50	60	70	80	90
			I/min	0	300	600	900	1200	1500	1800	2100	2400	3000	3600	4200	4800	5400
			m ³ /h	0	18	36	54	72	90	108	126	144	180	216	252	288	324
DGP 550/4/80 AOGT	4.6	60	12.3	11.4	10.5	9.6	8.7	7.6	6.4	4.9							
DGP 550/4/100 AOGT	4.6	70	8.9	8.5	8.1	7.7	7.2	6.6	5.9	5.1	4.2						
DGP 750/4/80 AOHT	6.5	68	14.9	14.2	13.5	12.8	11.9	11	9.9	8.6	7						
DGP 750/4/100 AOHT	6.5	85	11.5	10.9	10.3	9.6	8.8	8	7.1	6.2	5.2	3.2					
DGP 1000/4/80 AOHT	8.9	70	17.7	17.3	16.6	15.8	14.9	13.8	12.5	11.1	9.5	5.8					
DGP 1000/4/100 AOHT	8.9	85	14	13.4	12.8	12.2	11.5	10.7	9.8	8.9	7.9	5.5					
DGP 1000/4/125 AOHT	8.9	80	8.7	8.5	8.4	8.2	8	7.8	7.6	7.3	7	6.1	5.1	4.1			
DGP 1500/4/100 AOIT	13.6	98	17.7	17.5	17	16.5	15.8	14.9	13.9	12.9	11.7	9.2	6.7	4.3			
DGP 1500/4/125 AOIT	13.6	102	11.6	11.4	11.1	10.9	10.6	10.3	10	9.7	9.3	8.5	7.6	6.5	5.2		
DGP 2000/4/125 AOIT	16.4	102	14.1	13.9	13.7	13.5	13.3	13	12.7	12.3	11.9	10.9	9.7	8.4	7.1	5.7	

Tableau données techniques - DGP

Tabla de datos técnicos - DGP

Corbe Curva	Code Código	Modèle Modelo	Refoulement Caudal	Passage libre Paso libre (mm)	Puissance (kW) Potencia (kW)		Pôles Polos	V/~	Courant (A) Corrente (A)		Câble Cable	Kg
					P1	P2			Run	Start		
F1	0266	DGP 550/4/80 AOGT-E	80	60	5.8	4.6	4	400/3	10.1	40	4G2.5+3x1	81
G1	0267	DGP 550/4/100 AOGT-E	100	70	5.8	4.6	4	400/3	10.1	40	4G2.5+3x1	84
F2	0268	DGP 750/4/80 AOHT-E	80	68	7.9	6.5	4	400/3	14.9	68	7G1.5+3x0.75	122
G2	0269	DGP 750/4/100 AOHT-E	100	85	7.9	6.5	4	400/3	14.9	68	7G1.5+3x0.75	115
F3	0270	DGP 1000/4/80 AOHT-E	80	70	10.8	8.9	4	400/3	20	102	7G1.5+3x0.75	130
G3	0271	DGP 1000/4/100 AOHT-E	100	85	10.8	8.9	4	400/3	20	102	7G1.5+3x0.75	125
G4	0272	DGP 1500/4/100 AOIT-E	100	80	15.8	13.6	4	400/3	28.2	110	2x4G6 - 2x1	165
H1	0273	DGP 1000/4/125 AOIT-E	125	98	10.8	8.9	4	400/3	20	102	7G1.5+3x0.75	180
H2	0274	DGP 1500/4/125 AOIT-E	125	102	15.8	13.6	4	400/3	28.2	110	2x4G6 - 2x1	199
H3	0275	DGP 2000/4/125 AOIT-E	125	102	19.6	16.4	4	400/3	36	151	2x4G6 - 2x1	216

Modèles GRINDER (GRP) - AP (APP)

Modelos GRINDER (GRP) - AP (APP)

Avec système de broyage
Con sistema de trituración

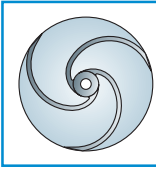
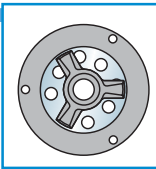

Grande hauteur manométrique
Altura de impulsión elevada

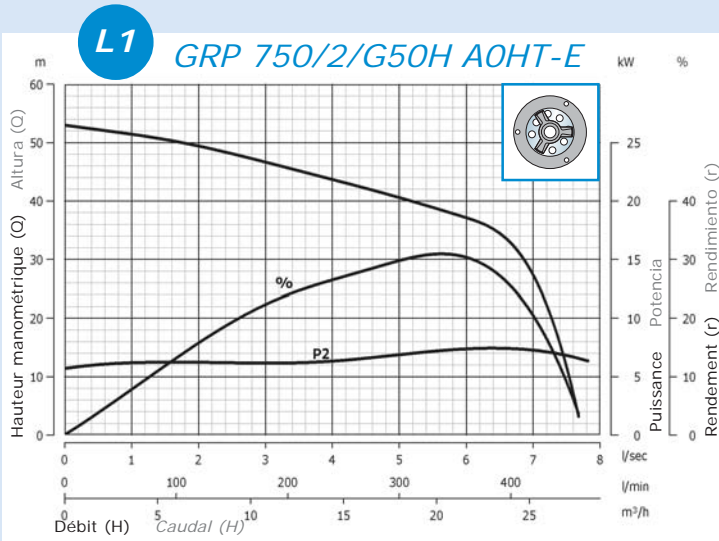

Roue mobile Impulsor	kW kW	Poles Polos	Ø Refoulement (mm) Ø Impulsión (mm)
	7.2	2	G50H

Roue mobile Impulsor	kW kW	Poles Polos	Ø Refoulement (mm) Ø Impulsión (mm)
	7.2 ÷ 10	2	G50H

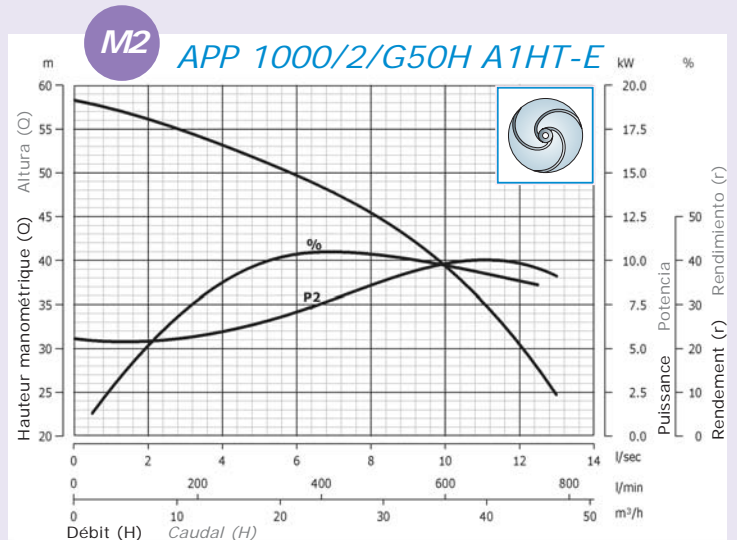
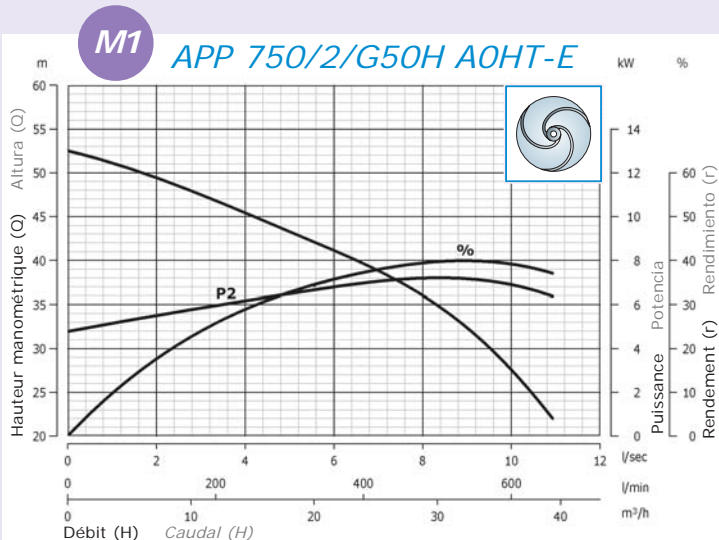

Données hydrauliques - GRP-APP

Datos hidráulicos - GRP-APP

kW	Passaggio libero (mm)	Débit (H) Caudal (H)															
		0	1	2	3	4	5	6	7	8	9	10	11	12			
GRP 750/2/G50H A0HT-E	7.2	-	5.3	51.4	49.4	46.7	43.7	40.6	37.1	27.3							
APP 750/2/G50H A0HT	7.2	10	52.5	51.1	49.4	47.5	45.4	43.3	41.1	38.8	36	32.4	27.6				
APP 1000/2/G50H A1HT	8.9	12	58.3	57.3	56.1	54.7	53.2	51.5	49.7	47.7	45.4	42.7	39.4	35.3	30.5		

Tableau données techniques - GRP-APP

Tabla de datos técnicos - GRP-APP

Corbe Curva	Code Código	Modèle Modelo	Refolement Caudal	Passage libre Paso libre (mm)	Puissance (kW) Potencia (kW)		Pôles Polos	Courant (A) Corrente (A)		Câble Cable	Kg	
					P1	P2		Run	Start			
L1	0304	GRP 750/2/G50H A0HT-E	GAS Ø2"	-	8.8	7.2	2	400/3	14.5	60	7G1.5+3x0.75	90
M1	0323	APP 750/2/G50H A0HT-E	GAS Ø2"	10	8.8	7.2	2	400/3	14.5	60	7G1.5+3x0.75	90
M2	0792	APP 1000/2/G50H A1HT-E	GAS Ø2"	12	11.9	10	2	400/3	19.8	87.8	7G1.5+3x0.75	96

Modèles SYSTEM M (SMP) - SYSTEM B (SBP)

Modelos SYSTEM M (SMP) - SYSTEM B (SBP)

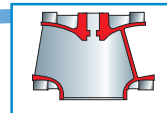

Monocanal fermée
Monocanal cerrado

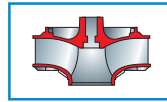

Bicanal fermée
Bicanal cerrado

Regroupements de courbes hydrauliques

Conjuntos de curvas hidráulicas

REGROUPEMENT CONJUNTO

N

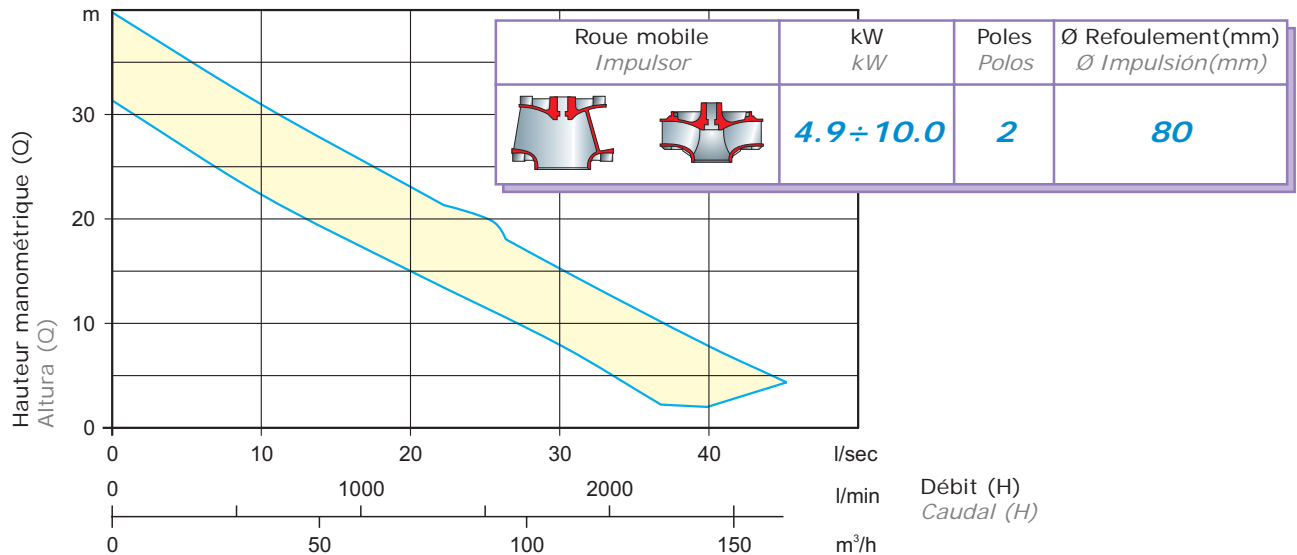

REGROUPEMENT CONJUNTO

P

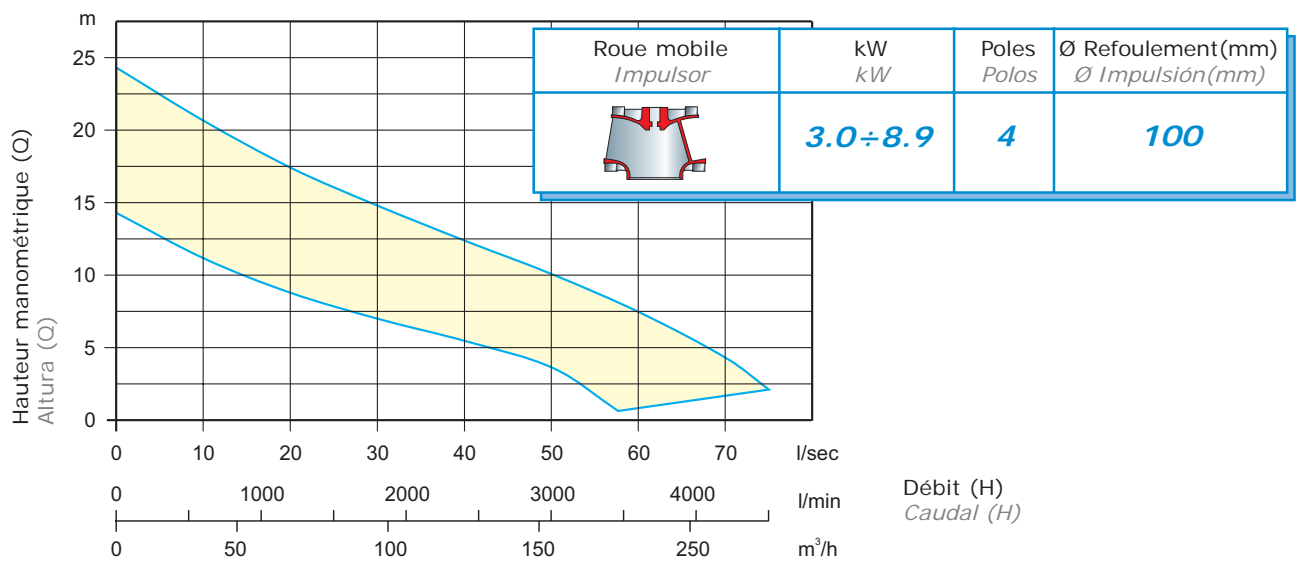

REGROUPEMENT CONJUNTO

Q

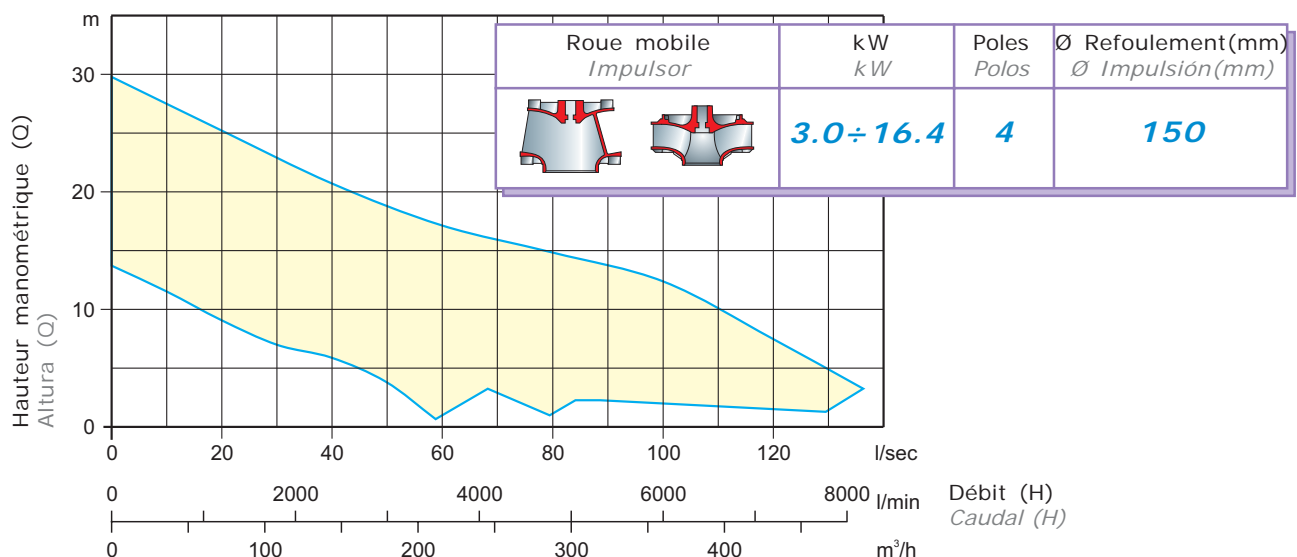

REGROUPEMENT CONJUNTO

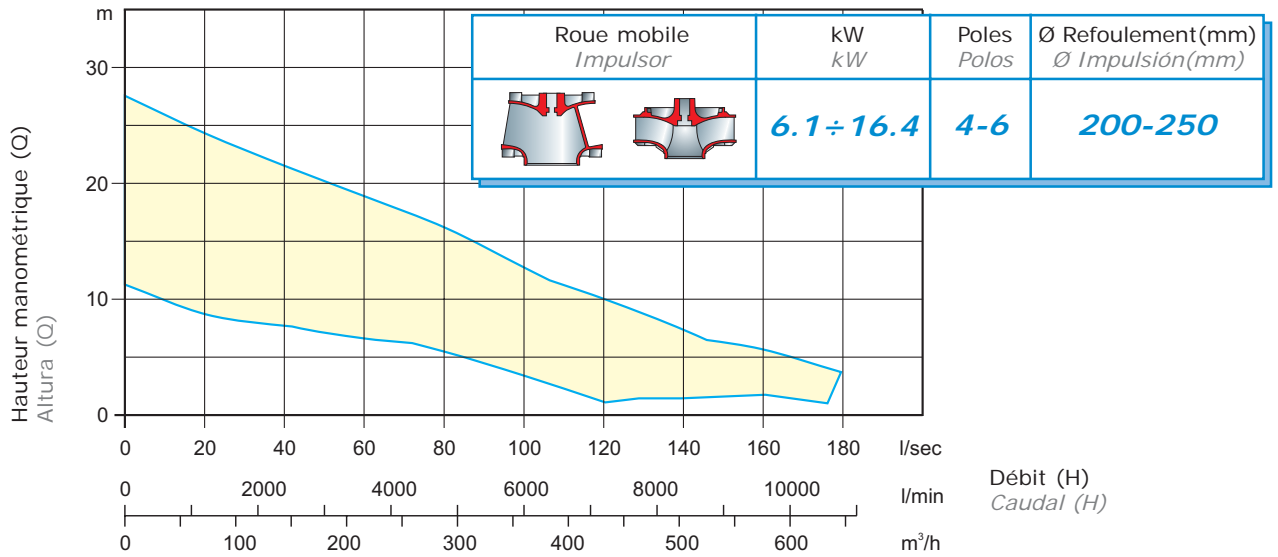

Courbes hydrauliques - SMP-SBP *Curvas hidráulicas - SMP-SBP*

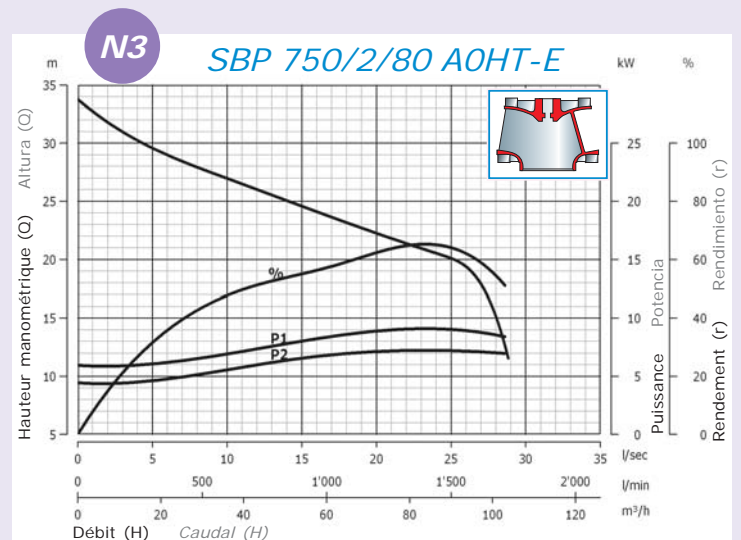
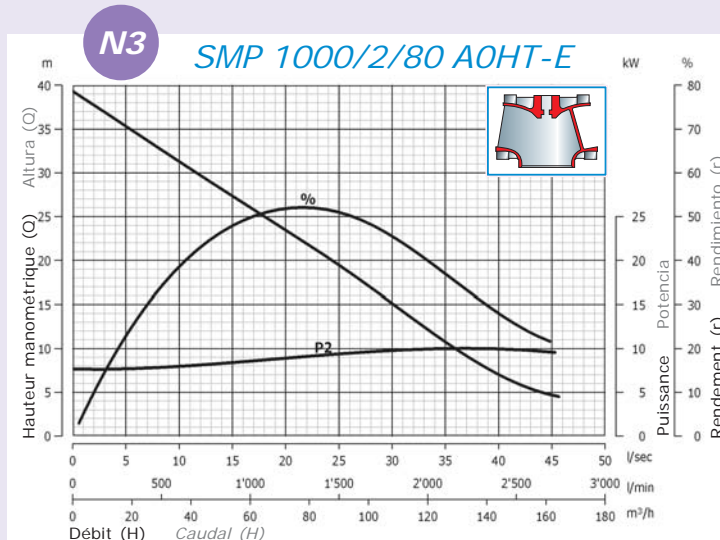
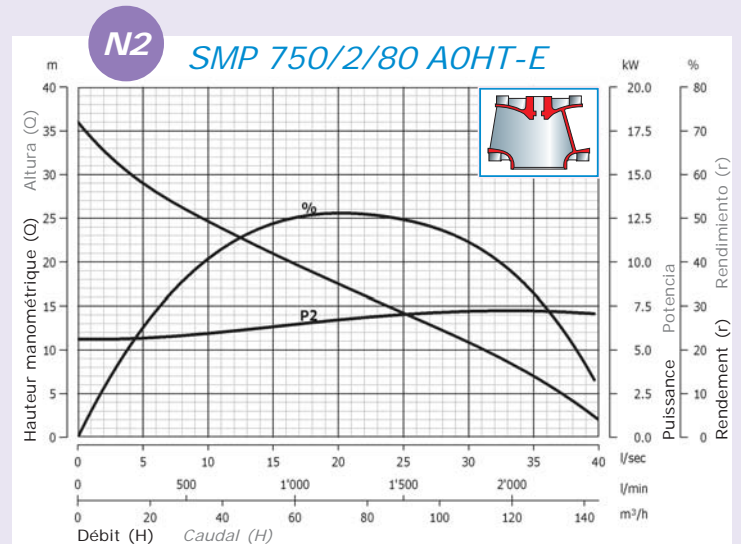
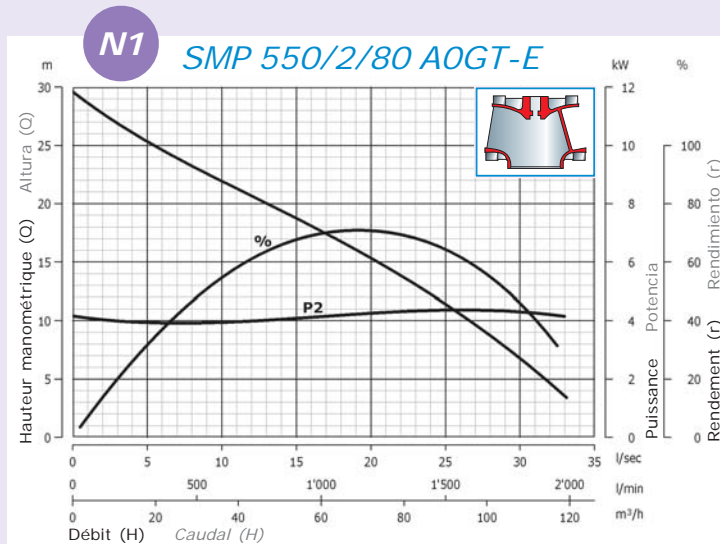

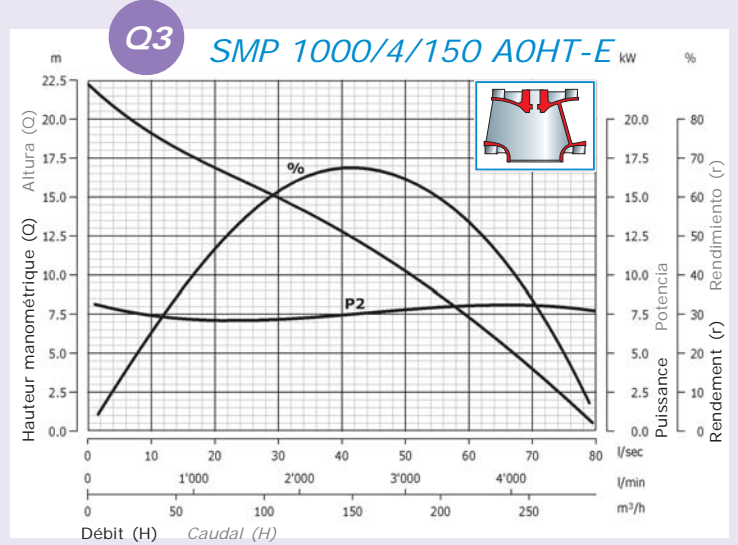
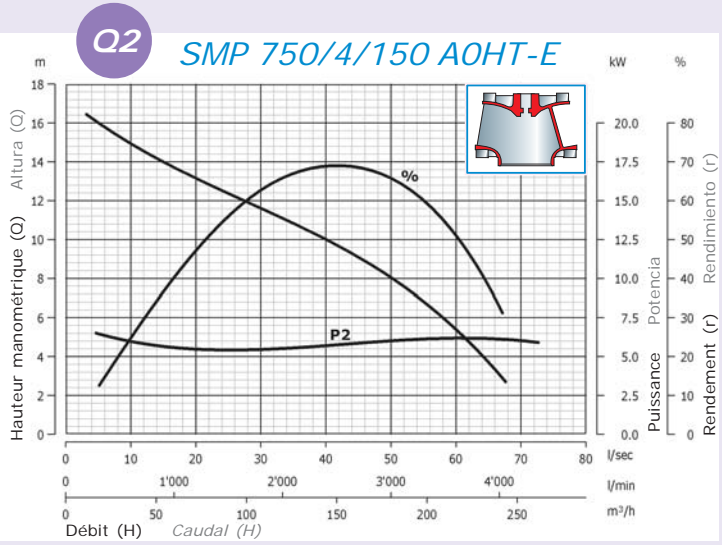
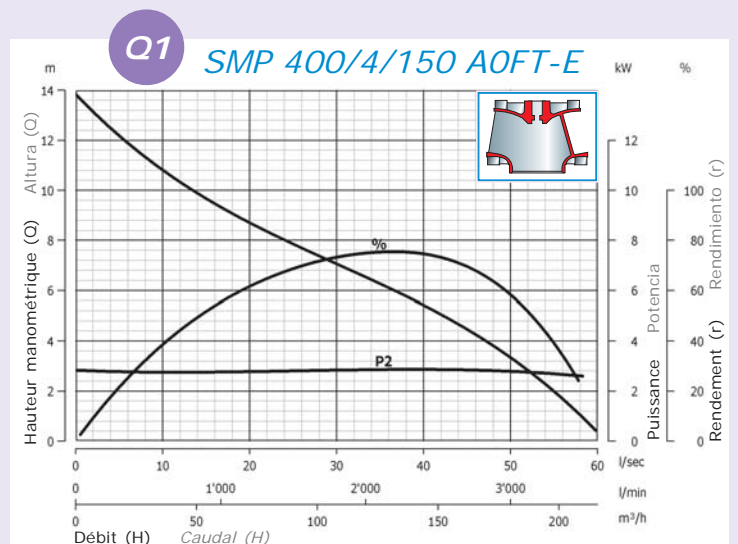
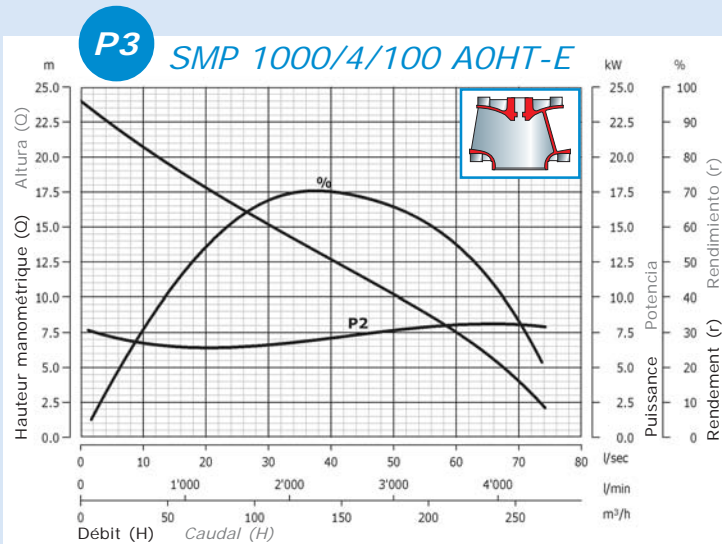
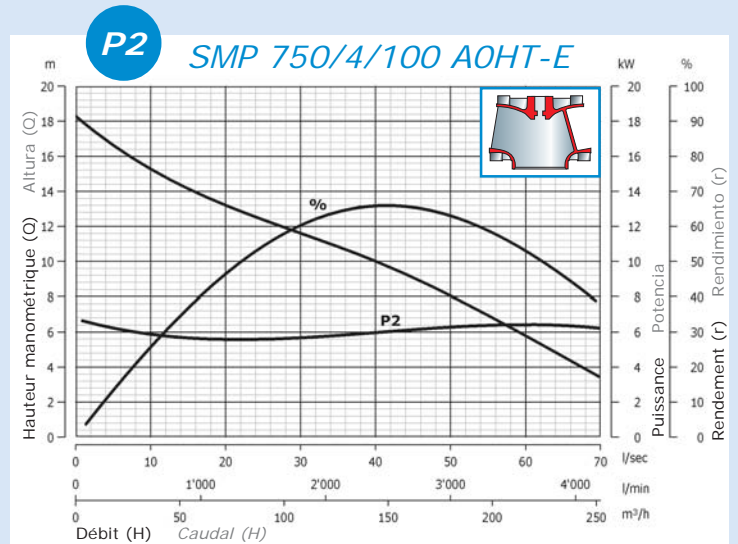
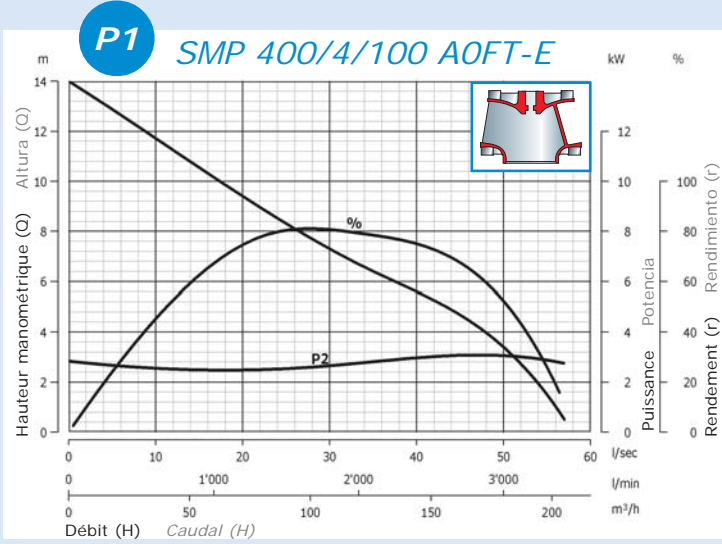

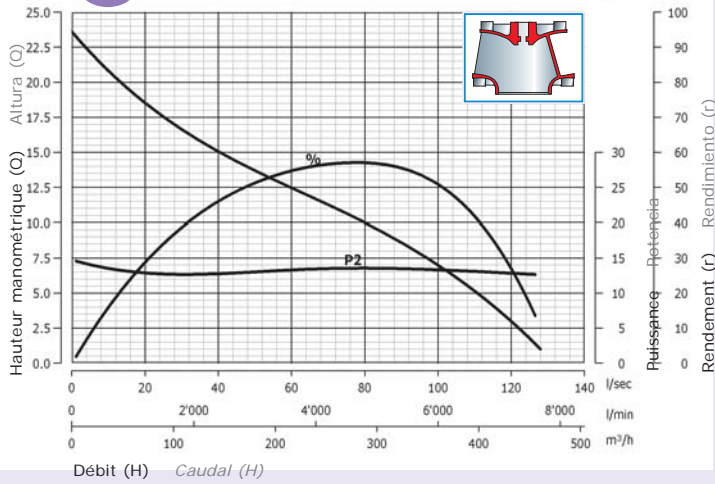
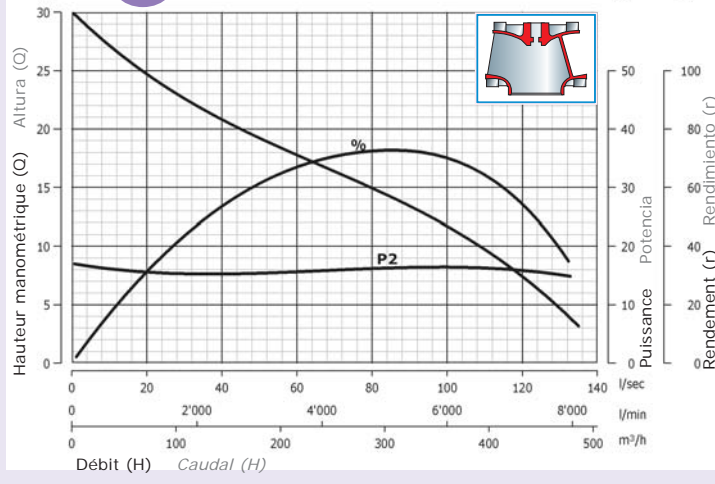
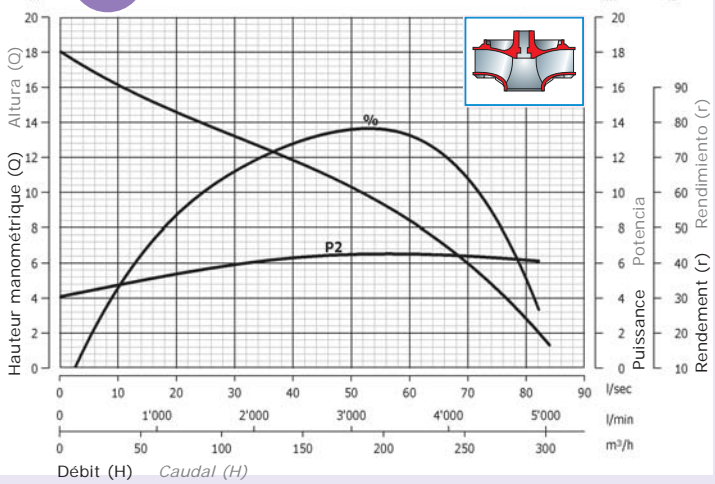
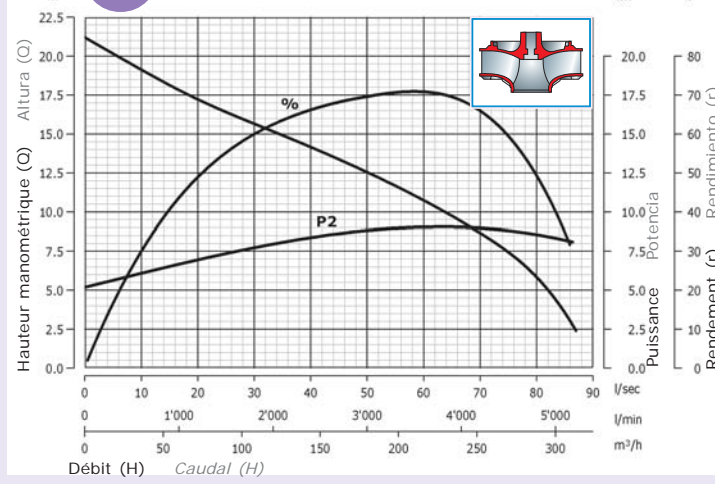
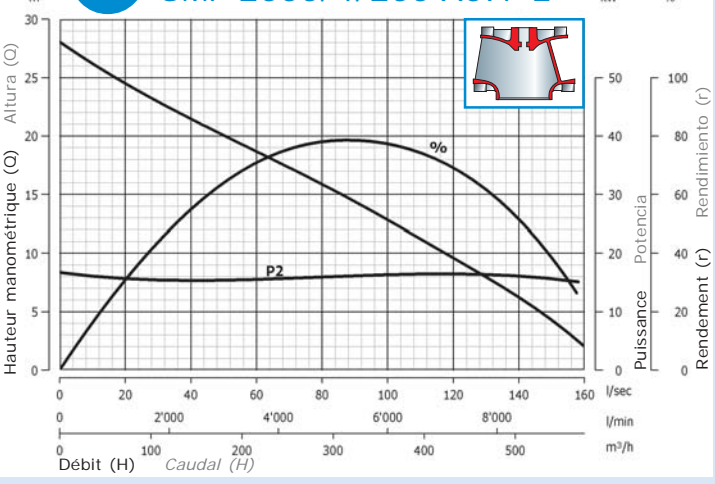
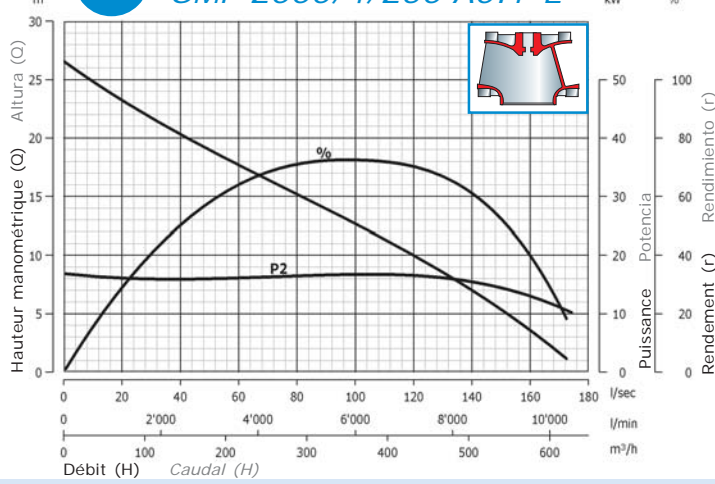
Q4**SMP 1500/4/150 AOIT-E****Q5****SMP 2000/4/150 AOIT-E****Q6****SBP 750/4/150 AOHT-E****Q7****SBP 1000/4/150 AOHT-E****R1****SMP 2000/4/200 AOIT-E****R2****SMP 2000/4/250 AOIT-E**

R3 SMP 750/6/200 AOHT-E

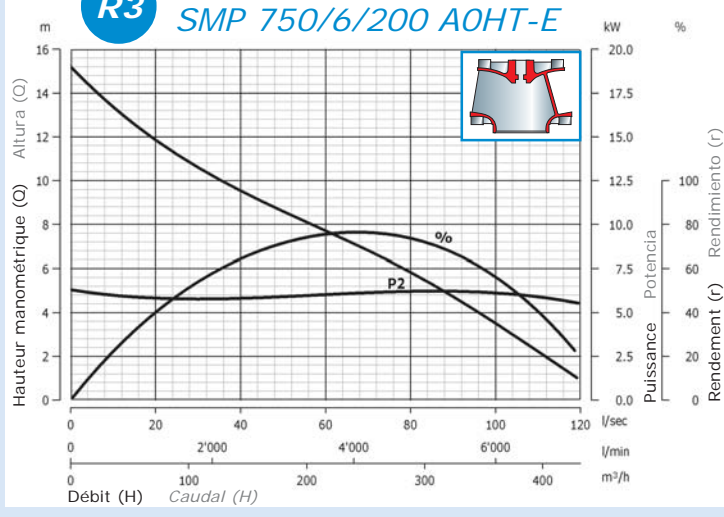

R4 SMP 750/6/250 AOHT-E

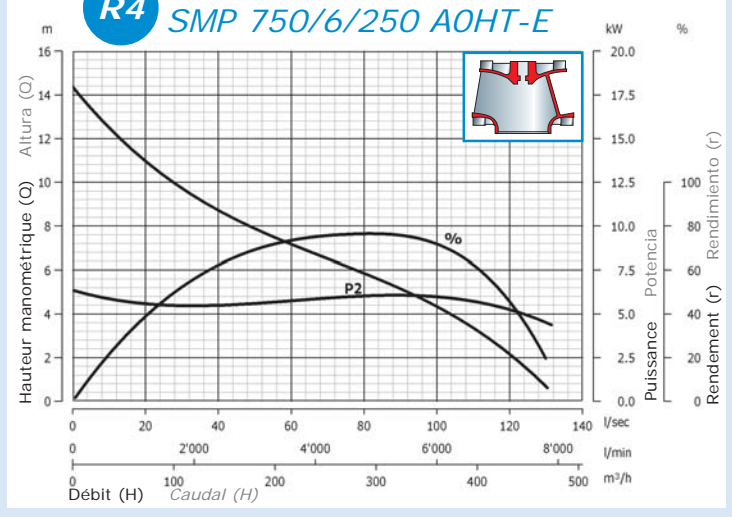

R5 SBP 1000/6/200 AOIT-E

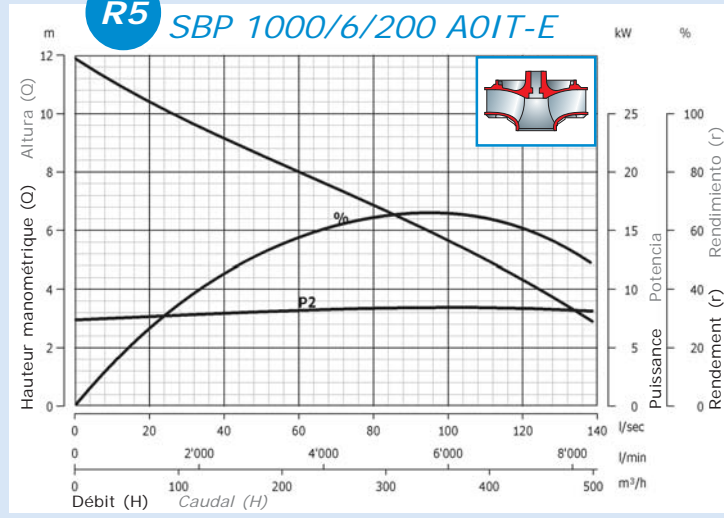

R6 SBP 1000/6/250 AOIT-E

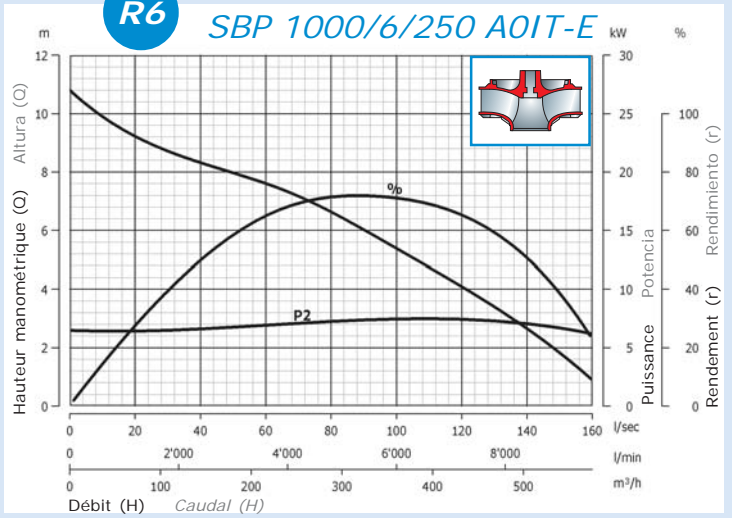

R7 SBP 1500/6/200 AOIT-E

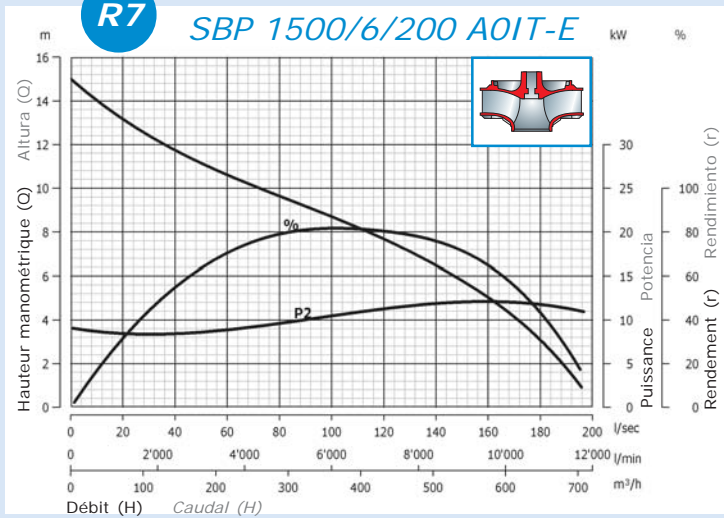

R8 SBP 1500/6/250 AOIT-E

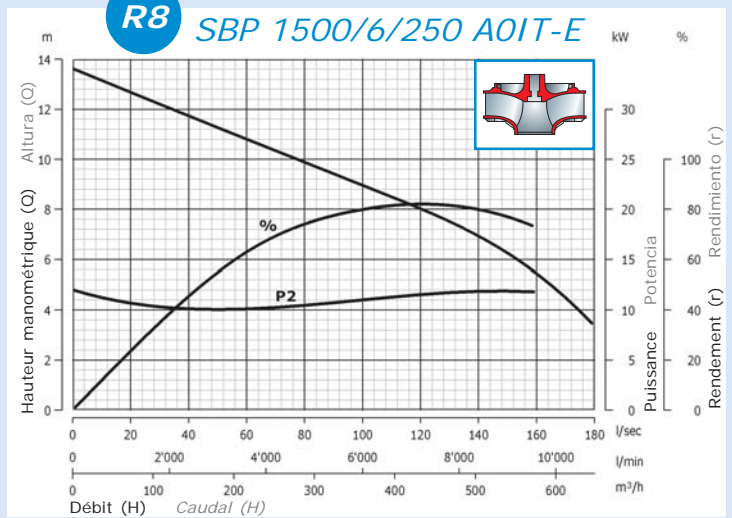

Données hydrauliques - SMP-SBP

Datos hidráulicos - SMP-SBP

kW	Passaggio libero(mm)	I/s	0	10	20	30	40	50	60	70	80	90	100	120	140	160
		l/min	0	600	1200	1800	2400	3000	3600	4200	4800	5400	6000	7200	8400	9600
		m³/h	0	36	72	108	144	180	216	252	288	324	360	432	504	576
SMP 550/2/80 AOHT	4.9	53	29.6	21.9	15.3	6.8										
SMP 750/2/80 AOHT	7.2	65	36	24.6	17.5	10.9	2									
SMP 1000/2/80 AOHT	8.9	65	39.3	31.3	23.5	15.1	7									
SMP 400/4/100 AOFT	3	100	14	11.7	9.4	7.3	5.6	3.4								
SMP 400/4/150 AOFT	3	100	13.8	10.8	8.7	7.1	5.4	3.3								
SMP 750/4/100 AOHT	6.5	100	18.3	15.3	13.2	11.6	10	8	5.8							
SMP 750/4/150 AOHT	6.5	100	17.2	14.9	13.2	11.6	10	8	5.4							
SMP 1000/4/100 AOHT	8.9	80	24	20.7	17.8	15.2	12.7	10.2	7.5	4						
SMP 1000/4/150 AOHT	8.9	80	22.2	19.1	16.9	15	12.8	10.2	7.3	4						
SMP 1500/4/150 AOIT	13.6	130	23.6	20.8	18.5	16.6	15.1	13.7	12.5	11.3	10	8.6	7	3		
SMP 2000/4/150 AOIT	16.4	130	30	27.2	24.7	22.6	20.8	19.2	17.8	16.4	14.9	13.4	11.7	7.4		
SMP 2000/4/200 AOIT	16.4	130	22.2	21.2	20.3	19.5	18.6	17.5	16.3	15.1	13.9	12.8	11.5	8.3	5.2	
SMP 2000/4/250 AOIT	16.4	130	27	24.1	21.5	19.4	17.9	17	16.3	15.3	14	12.8	11.6	9.3	6.6	4
SMP 750/6/200 AOHT	6.1	130	15.2	13.4	11.8	10.6	9.5	8.6	7.7	6.8	5.8	4.7	3.5			
SMP 750/6/250 AOHT	6.1	130	14.4	12.5	11	9.7	8.7	7.9	7.2	6.5	5.9	5.2	4.3	2.2		

kW	Passaggio libero(mm)	I/s	0	10	20	30	40	50	60	70	80	90	100	120	140	160	180
		l/min	0	600	1200	1800	2400	3000	3600	4200	4800	5400	6000	7200	8400	9600	10800
		m³/h	0	36	72	108	144	180	216	252	288	324	360	432	504	576	648
SBP 750/2/80 AOHT	7.2	36	33.8	27	22.2												
SBP 750/4/150 AOHT	6.5	70	18	16.1	14.6	13.2	11.8	10.3	8.4	6	2.8						
SBP 1000/4/150 AOHT	8.9	70	21.2	19.1	17.2	15.7	14.2	12.5	10.7	8.7	5.9						
SBP 1000/6/200 AOIT	8.4	100	11.9	11.1	10.4	9.8	9.2	8.6	8	7.4	6.9	6.3	5.7	4.3			
SBP 1000/6/250 AOIT	8.4	100	10.8	9.9	9.2	8.7	8.3	8	7.6	7.2	6.6	6	5.4	4.1	2.7		
SBP 1500/6/200 AOIT	12.3	140	15	14	13.2	12.4	11.7	11.1	10.6	10.1	9.6	9.2	8.7	7.7	6.5	5	
SBP 1500/6/250 AOIT	12.3	140	13.6	13.1	12.7	12.2	11.7	11.3	10.8	10.3	9.9	9.4	9	8	6.9	5.4	3.1

Tableau données techniques - SMP-SBP

Tabla de datos técnicos - SMP-SBP

Corbe	Code	Modèle	Refoulement	Passage libre	Puissance (kW)		Pôles	Courant (A)		Câble	Kg	
					P1	P2		Run	Start			
Curva	Código	Modelo	Caudal	Paso libre (mm)	Potencia (kW)		Polos	V/~		Cable		
N1	0397	SMP 550/2/80 AOHT-E	80	53	6	4.9	2	400/3	10.1	48	4G2.5+3x1	73
N2	0398	SMP 750/2/80 AOHT-E	80	55x65	8.8	7.2	2	400/3	14.5	60	7G1.5+3x0.75	76
N3	0399	SMP 1000/2/80 AOHT-E	80	55x65	11.9	10	2	400/3	19.8	87.8	7G1.5+3x0.75	110
P1	0400	SMP 400/4/100 AOFT-E	100	75x100	4.1	3	4	400/3	7.9	35	4G1.5 - 2x1	81
Q1	0401	SMP 400/4/150 AOFT-E	150	75x100	4.1	3	4	400/3	7.9	35	4G1.5 - 2x1	88
P2	0402	SMP 750/4/100 AOHT-E	100	80x100	7.9	6.5	4	400/3	14.9	68	7G1.5+3x0.75	132
Q2	0403	SMP 750/4/150 AOHT-E	150	80x100	7.9	6.5	4	400/3	14.9	68	7G1.5+3x0.75	140
P3	0404	SMP 1000/4/100 AOHT-E	100	80	10.8	8.9	4	400/3	20	102	7G1.5+3x0.75	141
Q3	0405	SMP 1000/4/150 AOHT-E	150	80	10.8	8.9	4	400/3	20	102	7G1.5+3x0.75	150
Q4	0406	SMP 1500/4/150 AOIT-E	150	100x130	15.8	13.6	4	400/3	28.2	110	2x4G6 - 2x1	206
Q5	0407	SMP 2000/4/150 AOIT-E	150	100x130	19.6	16.4	4	400/3	36	151	2x4G6 - 2x1	220
R1	0408	SMP 2000/4/200 AOIT-E	200	100x130	19.6	16.4	4	400/3	36	151	2x4G6 - 2x1	221
R2	0409	SMP 2000/4/250 AOIT-E	250	100x130	19.6	16.4	4	400/3	36	151	2x4G6 - 2x1	229
R3	0410	SMP 750/6/200 AOHT-E	200	100x130	8.1	6.1	6	400/3	15.2	67.4	7G1.5+3x0.75	190
R4	0411	SMP 750/6/250 AOHT-E	250	100x130	8.1	6.1	6	400/3	15.2	67.4	7G1.5+3x0.75	198
N4	0430	SBP 750/2/80 AOHT-E	80	36	8.7	7.2	2	400/3	14.5	60	7G1.5+3x0.75	103
Q6	0431	SBP 750/4/150 AOHT-E	150	70	7.9	6.5	4	400/3	14.9	68	7G1.5+3x0.75	135
Q7	0432	SBP 1000/4/150 AOHT-E	150	70	10.8	8.9	4	400/3	20	102	7G1.5+3x0.75	151
R5	0435	SBP 1000/6/200 AOIT-E	200	100	11	8.4	6	400/3	20.1	89.1	2x4G6 - 2x1	215
R6	0436	SBP 1000/6/250 AOIT-E	250	100	11	8.4	6	400/3	20.1	89.1	2x4G6 - 2x1	223
R7	0437	SBP 1500/6/200 AOIT-E	200	105x140	15.7	12.3	6	400/3	28.2	125	2x4G6 - 2x1	245
R8	0438	SBP 1500/6/250 AOIT-E	250	105x140	15.7	12.3	6	400/3	28.2	125	2x4G6 - 2x1	253

Installation libre - Instalación libre

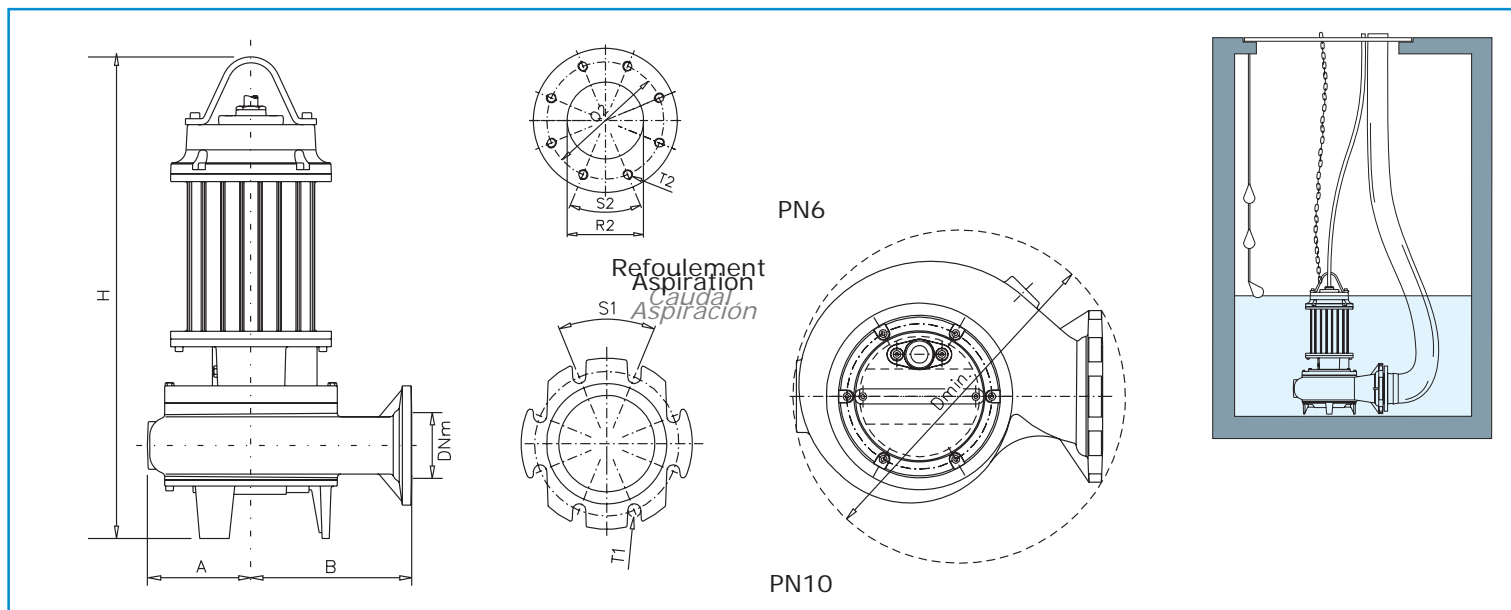

Modèles DRENO (DRP) - Modelos DRENO (DRP)

	A	B	Dmin	DNm	H	Q2	R2	S1°	S2°	T1	T2
	mm	mm	mm	mm	mm	mm	mm			mm	mm
DRP 750/2/80 AOHT-E	151	244	423	80	785	160	85	90	90	18	M16
DRP 1000/2/80 A1HT-E	151	244	423	80	785	160	85	90	90	18	M16
DRP 1000/2/100 A1HT-E	160	258	450	100	790	180	105	45	90	18	M16
DRP 1500/2/80 AOHT-E	151	244	423	80	816	160	85	90	90	18	M16
DRP 1500/2/100 AOHT-E	160	258	450	100	830	180	105	45	90	18	M16
DRP 2000/2/80 AOIT-E	151	244	423	80	870	160	85	90	90	18	M16
DRP 550/4/80 AOGT-E	151	244	423	80	695	160	85	90	90	18	M16
DRP 550/4/100 AOGT-E	160	258	450	100	708	180	105	45	90	18	M16
DRP 750/4/80 AOHT-E	174	272	462	80	808	160	85	90	90	18	M16
DRP 750/4/100 AOHT-E	165	260	457	100	820	180	105	45	90	18	M16
DRP 750/4/150 AOHT-E	197	288	523	150	850	240	157	45	45	22	M20
DRP 1000/4/80 AOHT-E	174	272	462	80	808	160	85	90	90	18	M16
DRP 1000/4/100 AOHT-E	165	260	457	100	820	180	105	45	90	18	M16
DRP 1000/4/150 AOHT-E	197	288	523	150	850	240	157	45	45	22	M20
DRP 1500/4/80 AOIT-E	200	255	474	80	886	160	85	90	90	18	M16
DRP 1500/4/100 AOIT-E	165	260	457	100	905	180	105	45	90	18	M16
DRP 1500/4/125 AOIT-E	278	303	603	125	945	240	150	90	45	18	M20
DRP 1500/4/150 AOIT-E	261	388	180	150	982	240	157	45	45	22	M20
DRP 2000/4/80 AOIT-E	200	255	474	80	886	160	85	90	90	18	M16
DRP 2000/4/125 AOIT-E	278	303	603	125	945	240	150	90	45	18	M20
DRP 2000/4/150 AOIT-E	261	388	180	150	982	240	157	45	45	22	M20
DRP 550/6/150 AOHT-E	197	288	523	150	865	240	157	45	45	22	M20
DRP 750/6/150 AOHT-E	261	388	680	150	928	240	157	45	45	22	M20
DRP 1000/6/150 AOIT-E	261	388	680	150	982	240	157	45	45	22	M20

Modèles DRAGA (DGP) - Modelos DRAGA (DGP)

	A	B	Dmin	DNm	H	Q2	R2	S1°	S2°	T1	T2
	mm	mm	mm	mm	mm	mm	mm			mm	mm
DGP 550/4/80 AOGT-E	151	244	423	80	695	160	85	90	90	18	M16
DGP 550/4/100 AOGT-E	160	258	450	100	707	180	105	45	90	18	M16
DGP 750/4/80 AOHT-E	174	272	462	80	808	160	85	90	90	18	M16
DGP 750/4/100 AOHT-E	165	260	457	100	820	180	105	45	90	18	M16
DGP 1000/4/80 AOHT-E	174	272	462	80	808	160	85	90	90	18	M16
DGP 1000/4/100 AOHT-E	165	260	457	100	820	180	105	45	90	18	M16
DGP 1000/4/125 AOHT-E	278	303	603	125	860	240	150	90	45	18	M20
DGP 1500/4/100 AOIT-E	165	260	457	100	905	180	105	45	90	18	M16
DGP 1500/4/125 AOIT-E	278	303	603	125	945	240	150	90	45	18	M20
DGP 2000/4/125 AOIT-E	278	303	603	125	945	240	150	90	45	18	M20

Modèles SYSTEM M (SMP) - Modelos SYSTEM M (SMP)

	A	B	D min	DNm	H	Q2	R2	S1°	S2°	T1	T2
	mm	mm	mm	mm	mm	mm	mm			mm	mm
SMP 550/2/80 AOHT-E	151	244	423	80	703	-	76	90	-	20	-
SMP 750/2/80 AOHT-E	151	244	423	80	703	-	76	90	-	20	-
SMP 1000/2/80 AOHT-E	151	244	423	80	703	-	76	90	-	20	-
SMP 400/4/100 AOFT-E	205	307	538	100	666	170	115	45	90	18	M16
SMP 400/4/150 AOFT-E	205	310	554	150	666	170	115	45	90	22	M16

Modèles SYSTEM B (SBP) - Modelos SYSTEM B (SBP)

	A	B	D min	DNm	H	Q2	R2	S1°	S2°	T1	T2
	mm	mm	mm	mm	mm	mm	mm			mm	mm
SBP 750/2/80 AOHT-E	135	213	375	80	740	130	76	90	90	18	M12
SBP 750/4/150 AOHT-E	224	360	619	150	855	200	133	45	45	22	M16
SBP 1000/4/150 AOHT-E	224	360	619	150	855	200	133	45	45	22	M16

Installation avec BASE INSTALACIÓN con BASE

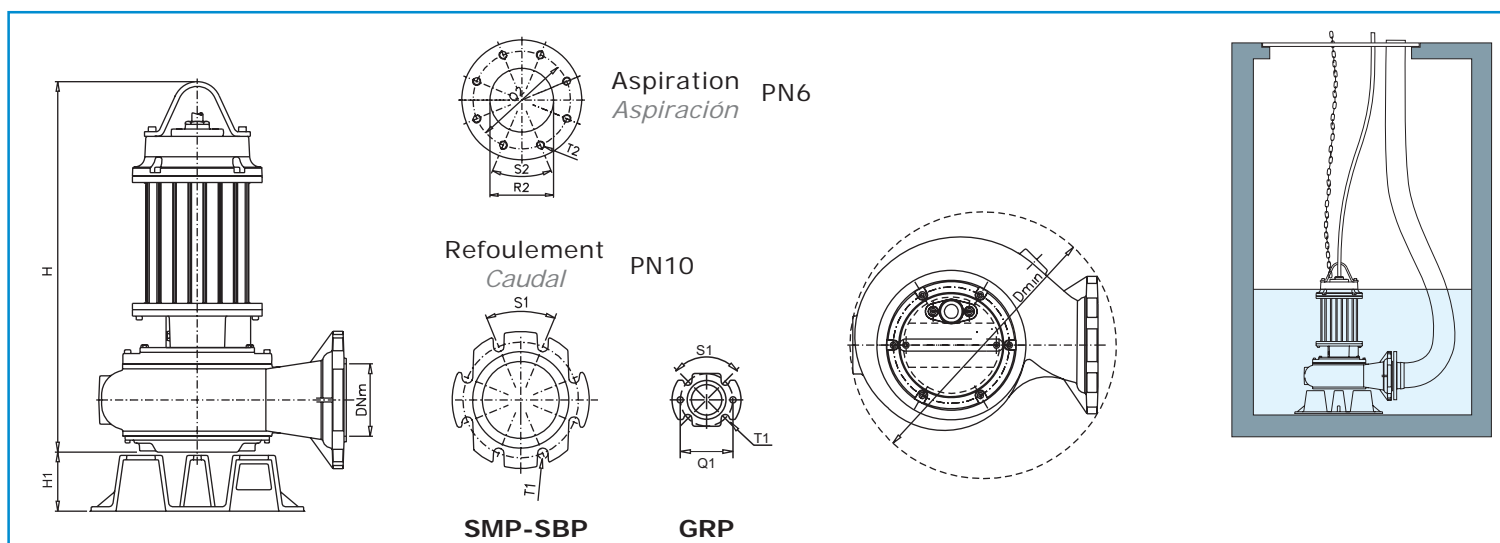

Modèles GRINDER (GRP) - Modelos GRINDER (GRP)

	D min	DNm	H	H1	Q1	S1	T1
	mm	inch	mm	mm	mm		mm
GRP 750/2/G50H AOHT-E	361	2	616	124	90	90°	14
APP 750/2/G50H AOHT-E	361	2	616	124	90	90°	14
APP 1000/2/G50H A1HT-E	361	2	616	124	90	90°	14

Modèles SYSTEM M (SMP) - Modelos SYSTEM M (SMP)

	D min	DNm	H	H1	Q2	R2	S1°	S2°	T1	T2
	mm	mm	mm	mm	mm	mm			mm	mm
SMP 750/4/100 AOHT-E	538	100	781	250	200	133	45	90	18	M16
SMP 750/4/150 AOHT-E	554	150	781	250	200	133	45	90	22	M16
SMP 1000/4/100 AOHT-E	538	100	781	250	200	133	45	90	18	M16
SMP 1000/4/150 AOHT-E	554	150	781	250	200	133	45	45	22	M16
SMP 1500/4/150 AOIT-E	680	150	888	170	240	165	45	60	22	M16
SMP 2000/4/150 AOIT-E	680	150	888	170	240	165	45	60	22	M16
SMP 2000/4/200 AOIT-E	740	200	903	170	240	165	45	60	22	M16
SMP 2000/4/250 AOIT-E	836	250	903	170	240	165	30	60	24	M16
SMP 750/6/200 AOHT-E	740	200	849	170	240	165	45	60	22	M16
SMP 750/6/250 AOHT-E	836	250	849	170	240	165	30	60	24	M16

Modèles SYSTEM B (SBP) - Modelos SYSTEM B (SBP)

	D min	DNm	H	H1	Q2	R2	S1°	S2°	T1	T2
	mm	mm	mm	mm	mm	mm			mm	mm
SBP 1000/6/200 AOIT-E	740	200	950	170	295	216	45	30	22	M20
SBP 1000/6/250 AOIT-E	836	250	950	170	295	216	30	30	24	M20
SBP 1500/6/200 AOIT-E	740	200	911	170	295	216	45	30	22	M20
SBP 1500/6/250 AOIT-E	836	250	911	170	295	216	30	30	24	M20

Installation dotée d'un DISPOSITIF D'ACCOUPLLEMENT HORIZONTAL

Instalación con DISPOSITIVO DE ACOPLAMIENTO HORIZONTAL

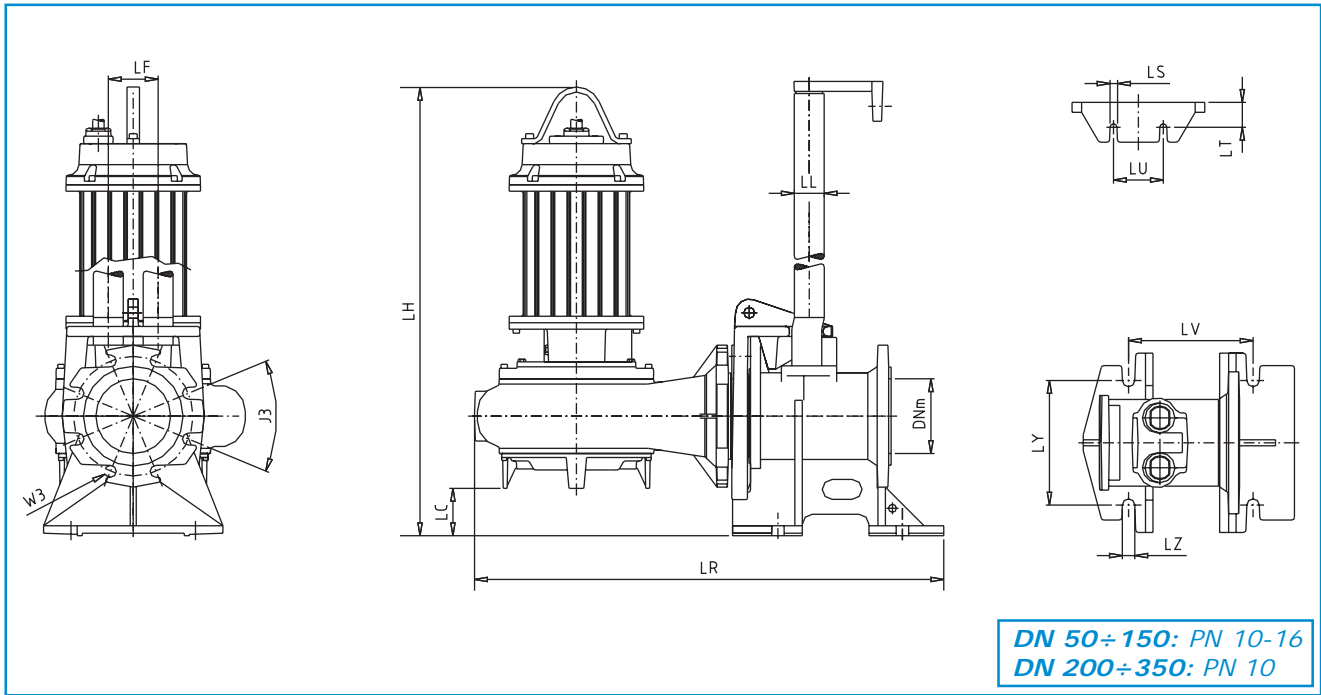

Modèles DRENO (DRP) - Modelos DRENO (DRP)

	DNm	LC	LF	LH	LL	LR	LS	LT	LU	LV	LY	LZ	J3°	W3
	mm	mm	mm	mm	inch	mm	mm	mm	mm	mm	mm	mm		mm
DRP 750/2/80 AOHT-E	80	39	100	824	2	660	14	50	100	250	200	14	45/90	18
DRP 1000/2/80 A1HT-E	80	39	100	824	2	660	14	50	100	250	200	14	45/90	18
DRP 1000/2/100 A1HT-E	100	34	100	824	2	693	14	50	100	250	200	16	45	18
DRP 1500/2/80 AOHT-E	80	39	100	855	2	660	14	50	100	250	200	14	45/90	18
DRP 1500/2/100 AOHT-E	100	34	100	864	2	693	14	50	100	250	200	16	45	18
DRP 2000/2/80 AOIT-E	80	39	100	909	2	660	14	50	100	250	200	14	45/90	18
DRP 550/4/80 AOGT-E	80	39	100	734	2	660	14	50	100	250	200	14	45/90	18
DRP 550/4/100 AOGT-E	100	34	100	742	2	693	14	50	100	250	200	16	45	18
DRP 750/4/80 AOHT-E	80	34	100	842	2	711	14	50	100	250	200	14	45/90	18
DRP 750/4/100 AOHT-E	100	30	100	850	2	700	14	50	100	250	200	16	45	18
DRP 750/4/150 AOHT-E	150	51	100	901	2	799	14	50	100	250	250	25	45	22
DRP 1000/4/80 AOHT-E	80	34	100	842	2	711	14	50	100	250	200	14	45/90	18
DRP 1000/4/100 AOHT-E	100	30	100	850	2	700	14	50	100	250	200	16	45	18
DRP 1000/4/150 AOHT-E	150	51	100	901	2	799	14	50	100	250	250	25	45	22
DRP 1500/4/80 AOIT-E	80	40	100	926	2	720	14	50	100	250	200	14	45/90	18
DRP 1500/4/100 AOIT-E	100	30	100	935	2	700	14	50	100	250	200	16	45	18
DRP 1500/4/125 AOIT-E	-	-	-	-	-	-	-	-	-	-	-	-	-	-
DRP 1500/4/150 AOIT-E	150	7	100	1072	2	963	14	50	100	250	250	25	45	22
DRP 2000/4/80 AOIT-E	80	40	100	926	2	720	14	50	100	250	200	14	45/90	18
DRP 2000/4/125 AOIT-E	-	-	-	-	-	-	-	-	-	-	-	-	-	-
DRP 2000/4/150 AOIT-E	150	7	100	1072	2	963	14	50	100	250	250	25	45	22
DRP 550/6/150 AOHT-E	150	51	100	916	2	799	14	50	100	250	250	25	45	22
DRP 750/6/150 AOHT-E	150	7	100	989	2	963	14	50	100	250	250	25	45	22
DRP 1000/6/150 AOHT-E	150	7	100	989	2	963	14	50	100	250	250	25	45	22

Modèles DRAGA (DGP) - Modelos DRAGA (DGP)

	DNm	LC	LF	LH	LL	LR	LS	LT	LU	LV	LY	LZ	J3°	W3
	mm	mm	mm	mm	inch	mm	mm	mm	mm	mm	mm	mm		mm
DGP 550/4/80 AOGT-E	80	39	100	724	2	660	14	50	100	250	200	14	45/90	18
DGP 550/4/100 AOGT-E	100	34	100	734	2	583	14	50	100	250	200	16	45	18
DGP 750/4/80 AOHT-E	80	34	100	741	2	711	14	50	100	250	200	14	45/90	18
DGP 750/4/100 AOHT-E	100	30	100	850	2	690	14	50	100	250	200	16	45	18
DGP 1000/4/80 AOHT-E	80	34	100	842	2	711	14	50	100	250	200	14	45/90	18
DGP 1000/4/100 AOHT-E	100	30	100	850	2	690	14	50	100	250	200	16	45	18
DGP 1000/4/125 AOHT-E	-	-	-	-	-	-	-	-	-	-	-	-	-	-
DGP 1500/4/100 AOIT-E	100	30	100	935	2	690	14	50	100	250	200	16	45	18
DGP 1500/4/125 AOIT-E	-	-	-	-	-	-	-	-	-	-	-	-	-	-
DGP 2000/4/125 AOIT-E	-	-	-	-	-	-	-	-	-	-	-	-	-	-

Modèles SYSTEM M (SMP) - Modelos SYSTEM M (SMP)

	DNm	LC	LF	LH	LL	LR	LS	LT	LU	LV	LY	LZ	W3	
	mm	mm	mm	mm	inch	mm	mm	mm	mm	mm	mm	mm	J3°	
SMP 550/2/80 AOHT-E	80	39	100	742	2	660	14	50	100	250	200	14	45/90	18
SMP 750/2/80 AOHT-E	80	39	100	742	2	660	14	50	100	250	200	14	45/90	18
SMP 1000/2/80 AOHT-E	80	39	100	742	2	660	14	50	100	250	200	14	45/90	18
SMP 400/4/100 AOFT-E	100	58	100	724	2	787	14	50	100	250	200	16	45	18
SMP 400/4/150 AOFT-E	150	108	100	774	2	829	14	50	100	250	250	25	45	24
SMP 750/4/100 AOHT-E	100	45	100	851	2	787	14	50	100	250	200	16	45	18
SMP 750/4/150 AOHT-E	150	95	100	901	2	829	14	50	100	250	250	25	45	24
SMP 1000/4/100 AOHT-E	100	45	100	851	2	787	14	50	100	250	200	16	45	18
SMP 1000/4/150 AOHT-E	150	95	100	901	2	829	14	50	100	250	250	25	45	24
SMP 1500/4/150 AOIT-E	150	54	100	989	2	963	14	50	100	250	250	25	45	24
SMP 2000/4/150 AOIT-E	150	54	100	989	2	963	14	50	100	250	250	25	45	24
SMP 2000/4/200 AOIT-E	200	46	100	996	2	1022	14	50	100	250	250	25	45	24
SMP 2000/4/250 AOIT-E	250	181	100	1131	2	1205	14	50	100	400	250	25	30	22
SMP 750/6/200 AOHT-E	200	46	100	942	2	1022	14	50	100	250	250	25	45	24
SMP 750/6/250 AOHT-E	250	181	100	1077	2	1205	14	50	100	400	250	25	30	22

Modèles SYSTEM B (SBP) - Modelos SYSTEM B (SBP)

	DNm	LC	LF	LH	LL	LR	LS	LT	LU	LV	LY	LZ	W3	
	mm	mm	mm	mm	inch	mm	mm	mm	mm	mm	mm	mm	J3°	
SBP 750/2/80 AOHT-E	80	78	100	818	2	613	14	50	100	250	200	14	45/90	18
SBP 750/4/150 AOHT-E	150	38	100	893	2	898	14	50	100	250	250	25	45	24
SBP 1000/4/150 AOHT-E	150	38	100	893	2	898	14	50	100	250	250	25	45	24
SBP 1000/6/200 AOIT-E	200	46	100	996	2	1022	14	50	100	250	250	25	45	24
SBP 1000/6/250 AOIT-E	250	171	100	1131	2	1202	14	50	100	400	250	25	30	22
SBP 1500/6/200 AOIT-E	200	46	100	996	2	1022	14	50	100	250	250	25	45	24
SBP 1500/6/250 AOIT-E	250	171	100	1131	2	1202	14	50	100	400	250	25	30	22

Modèles GRINDER (GRP) - Modelos GRINDER (GRP)

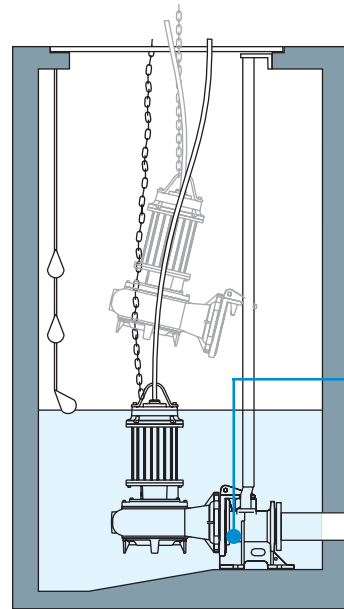
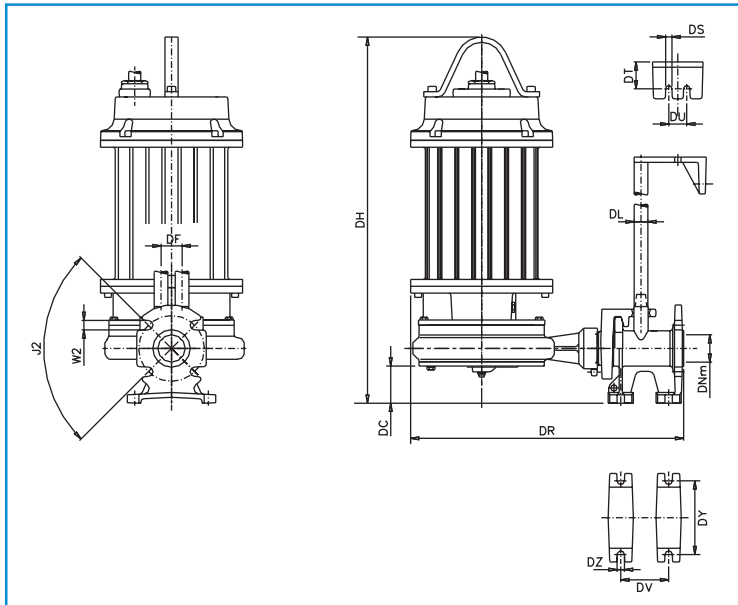

Nouveau système de décrochage rapide BREVETE
Nuevo sistema de desenganche rápido PATENTADO

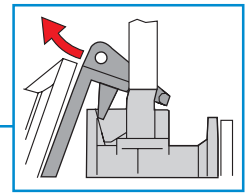
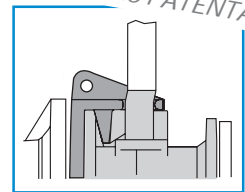

	DC	DF	DH	DL	DNm	DR	DS	DT	DU	DV	DY	DZ	W2	
	mm	mm	mm	inch	mm	mm	mm	mm	mm	mm	mm	mm	J2°	
GRP 750/2/G50H AOHT-E	78	40	695	3/4	50	515	12	51	34	91	140	13	90	18
APP 750/2/G50H AOHT-E	78	40	695	3/4	50	515	12	51	34	91	140	13	90	18
APP 1000/2/G50H A1HT-E	78	40	695	3/4	50	515	12	51	34	91	140	13	90	18

Installation dotée d'un DISPOSITIF D'ACCOUPLMENT VERTICAL

Instalación con DISPOSITIVO DE ACOPLAMIENTO VERTICAL

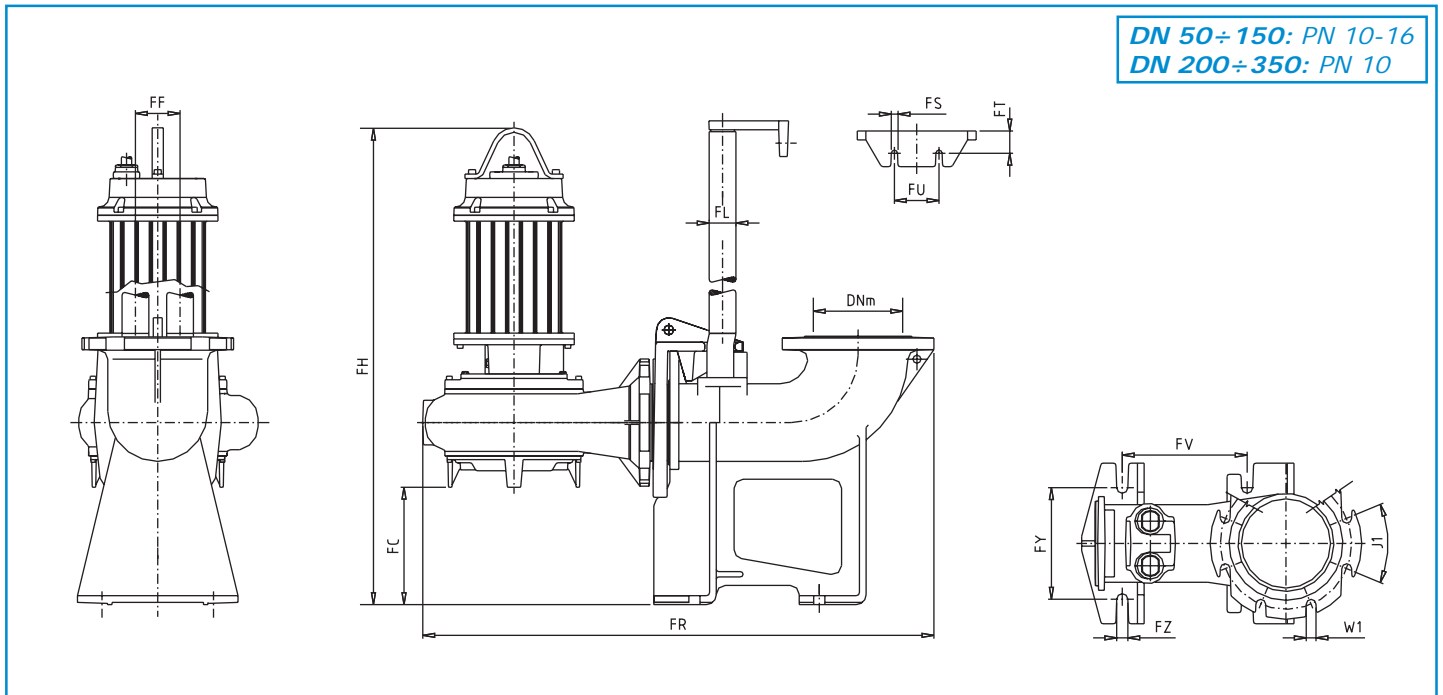

Modèles DRENO (DRP) - Modelos DRENO (DRP)

	DNm	FC	FF	FH	FL	FR	FS	FT	FU	FV	FY	FZ	J1°	W1
	mm	mm	mm	mm	inch	mm	mm	mm	mm	mm	mm	mm		mm
DRP 750/2/80 AOHT-E	80	39	61	824	1 1/2	736	12	51	34	250	200	14	90	18
DRP 1000/2/80 A1HT-E	80	39	61	824	1 1/2	736	12	51	34	250	200	14	90	18
DRP 1000/2/100 A1HT-E	100	34	61	824	1 1/2	781	12	51	34	250	200	16	45	18
DRP 1500/2/80 AOHT-E	80	39	61	855	1 1/2	736	12	51	34	250	200	14	90	18
DRP 1500/2/100 AOHT-E	100	34	61	864	1 1/2	781	12	51	34	250	200	16	45	18
DRP 2000/2/80 AOIT-E	80	39	61	909	1 1/2	736	12	51	34	250	200	14	90	18
DRP 550/4/80 AOGT-E	80	39	61	734	1 1/2	736	12	51	34	250	200	14	90	18
DRP 550/4/100 AOGT-E	100	28	61	736	1 1/2	781	12	51	34	250	200	16	45	18
DRP 750/4/80 AOHT-E	80	34	61	842	1 1/2	787	12	51	34	250	200	14	90	18
DRP 750/4/100 AOHT-E	100	30	61	850	1 1/2	788	12	51	34	250	200	16	45	18
DRP 750/4/150 AOHT-E	200	219	100	1069	2	1116	14	50	100	280	250	25	45	22
DRP 1000/4/80 AOHT-E	80	34	61	842	1 1/2	787	12	51	34	250	200	14	90	18
DRP 1000/4/100 AOHT-E	100	30	61	850	1 1/2	788	12	51	34	250	200	16	45	18
DRP 1000/4/150 AOHT-E	200	219	100	1069	2	1116	14	50	100	280	250	25	45	22
DRP 1500/4/80 AOIT-E	80	40	61	926	1 1/2	796	12	51	34	250	200	14	90	18
DRP 1500/4/100 AOIT-E	100	30	61	935	1 1/2	788	12	51	34	250	200	16	45	18
DRP 1500/4/125 AOIT-E	125	21	80	966	2	1046	14	50	100	310	90	13	45	18
DRP 1500/4/150 AOIT-E	200	175	100	1157	2	1280	14	50	100	280	250	25	45	22
DRP 2000/4/80 AOIT-E	80	40	61	926	1 1/2	796	12	51	34	250	200	14	90	18
DRP 2000/4/125 AOIT-E	125	21	80	966	2	1046	14	50	100	310	90	13	45	18
DRP 2000/4/150 AOIT-E	200	175	100	1157	2	1280	14	50	100	280	250	25	45	22
DRP 550/6/150 AOHT-E	200	219	100	1084	2	1116	14	50	100	280	250	25	45	22
DRP 750/6/150 AOHT-E	200	175	100	1103	2	1280	14	50	100	280	250	25	45	22
DRP 1000/6/150 AOHT-E	200	175	100	1157	2	1280	14	50	100	280	250	25	45	22

Modèles DRAGA (DGP) - Modelos DRAGA (DGP)

	DNm	FC	FF	FH	FL	FR	FS	FT	FU	FV	FY	FZ	J1°	W1
	mm	mm	mm	mm	inch	mm	mm	mm	mm	mm	mm	mm		mm
DGP 550/4/80 AOGT-E	80	39	61	734	1 1/2	736	12	51	34	250	200	14	90	18
DGP 550/4/100 AOGT-E	100	34	61	741	1 1/2	781	12	51	34	250	200	16	45	18
DGP 750/4/80 AOHT-E	80	34	61	842	1 1/2	787	12	51	34	250	200	14	90	18
DGP 750/4/100 AOHT-E	100	30	61	850	1 1/2	788	12	51	34	250	200	16	45	18
DGP 1000/4/80 AOHT-E	80	34	61	842	1 1/2	787	12	51	34	250	200	14	90	18
DGP 1000/4/100 AOHT-E	100	30	61	850	1 1/2	788	12	51	34	250	200	16	45	18
DGP 1000/4/125 AOHT-E	125	21	80	966	2	1046	14	50	100	310	90	13	45	18
DGP 1500/4/100 AOIT-E	100	30	61	935	1 1/2	788	12	51	34	250	200	16	45	18
DGP 1500/4/125 AOIT-E	125	21	80	966	2	1046	14	50	100	310	90	13	45	18
DGP 2000/4/125 AOIT-E	125	21	80	1094	2	1046	14	50	100	310	90	13	45	18

Modèles SYSTEM M (SMP) - Modelos SYSTEM M (SMP)

	DNm	FC	FF	FH	FL	FR	FS	FT	FU	FV	FY	FZ	J1°	W1
	mm	mm	mm	mm	inch	mm	mm	mm	mm	mm	mm	mm		mm
SMP 550/2/80 AOHT-E	80	39	61	742	1 1/2	736	12	51	34	250	200	14	90	18
SMP 750/2/80 AOHT-E	80	39	61	832	1 1/2	736	12	51	34	250	200	14	90	18
SMP 1000/2/80 AOHT-E	80	39	61	832	1 1/2	736	12	51	34	250	200	14	90	18
SMP 400/4/100 AOFT-E	100	58	61	724	1 1/2	875	12	51	34	250	200	16	45	18
SMP 400/4/150 AOFT-E	200	276	100	942	2	1146	14	50	100	280	250	25	45	22
SMP 750/4/100 AOHT-E	100	45	61	851	1 1/2	875	12	51	34	250	200	16	45	18
SMP 750/4/150 AOHT-E	200	263	100	1069	2	1146	14	50	100	280	250	25	45	22
SMP 1000/4/100 AOHT-E	100	45	61	851	1 1/2	875	12	51	34	250	200	16	45	18
SMP 1000/4/150 AOHT-E	200	263	100	1069	2	1146	14	50	100	280	250	25	45	22
SMP 1500/4/150 AOIT-E	200	222	100	1157	2	1280	14	50	100	280	250	25	45	22
SMP 2000/4/150 AOIT-E	200	222	100	1157	2	1280	14	50	100	280	250	25	45	22
SMP 2000/4/200 AOIT-E	250	177	100	1127	2	1409	14	50	100	500	250	25	30	22
SMP 2000/4/250 AOIT-E	300	331	100	1281	2	1602	14	50	100	500	250	25	30	22
SMP 750/6/200 AOHT-E	250	177	100	1073	2	1409	14	50	100	500	250	25	30	22
SMP 750/6/250 AOHT-E	300	331	100	1227	2	1602	14	50	100	500	250	25	30	22

Modèles SYSTEM B (SBP) - Modelos SYSTEM B (SBP)

	DNm	FC	FF	FH	FL	FR	FS	FT	FU	FV	FY	FZ	J1°	W1
	mm	mm	mm	mm	inch	mm	mm	mm	mm	mm	mm	mm		mm
SBP 750/2/80 AOHT-E	80	78	61	818	1 1/2	689	12	51	34	250	200	14	90	18
SBP 750/4/150 AOHT-E	200	206	100	1061	2	1215	14	50	100	280	250	25	45	22
SBP 1000/4/150 AOHT-E	200	206	100	1061	2	1215	14	50	100	280	250	25	45	22
SBP 1000/6/200 AOIT-E	250	177	100	1127	2	1409	14	50	100	500	250	25	30	22
SBP 1000/6/250 AOIT-E	300	331	100	1281	2	1602	14	50	100	500	250	25	30	22
SBP 1500/6/200 AOIT-E	250	167	100	1127	2	1409	14	50	100	500	250	25	30	22
SBP 1500/6/250 AOIT-E	300	321	100	1281	2	1602	14	50	100	500	250	25	30	22

Modèles GRINDER (GRP) - Modelos GRINDER (GRP)

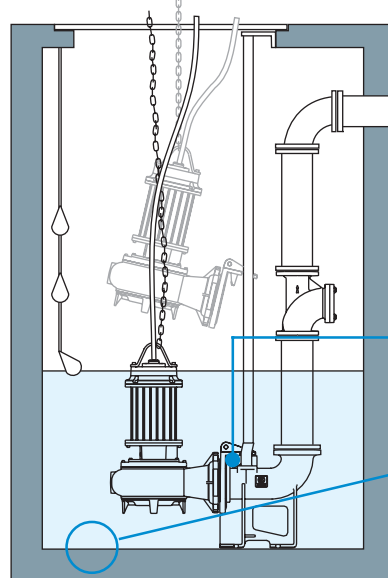
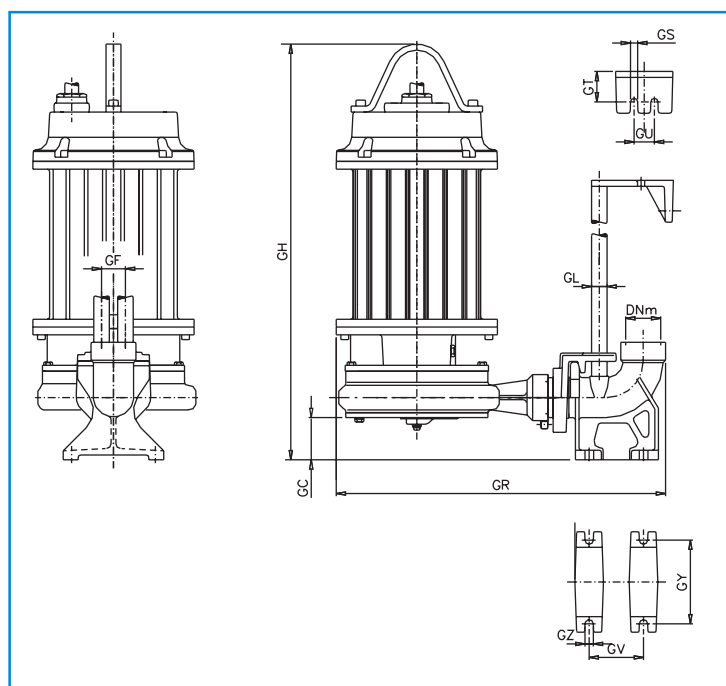

Nouveau système de décrochage rapide BREVETE
 Nuevo sistema de desenganche rápido PATENTADO

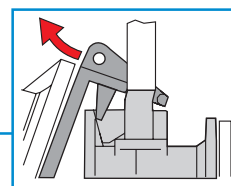
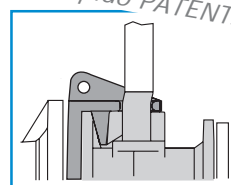

La marche au fond de la cuve n'est pas nécessaire
 No es necesario el peldaño en el fondo de la cuba

	DNm	GC	GF	GH	GL	GR	GS	GT	GU	GV	GY	GZ
	inch	mm	mm	mm	inch	mm	mm	mm	mm	mm	mm	mm
GRP 750/2/G50H AOHT-E	2	78	40	695	3/4	546	12	51	34	91	140	13
APP 750/2/G50H AOHT-E	2	78	40	695	3/4	546	12	51	34	91	140	13
APP 1000/2/G50H A1HT-E	2	78	40	695	3/4	546	12	51	34	91	140	13

Les données reportées ne sont pas contraignantes.
Zenit se réserve la faculté d'apporter des modifications au produit, sans donner de préavis.
*Los datos comunicados no se consideran obligatorios.
Zenit se reserva el derecho de aportar modificaciones al producto sin previo aviso.*



motralec

4 rue Lavoisier . ZA Lavoisier . 95223 HERBLAY CEDEX
Tel. : 01.39.97.65.10 / Fax. : 01.39.97.68.48
Demande de prix / e-mail : service-commercial@motralec.com
www.motralec.com